

LFS

Media columns

The most attractive channels for energy

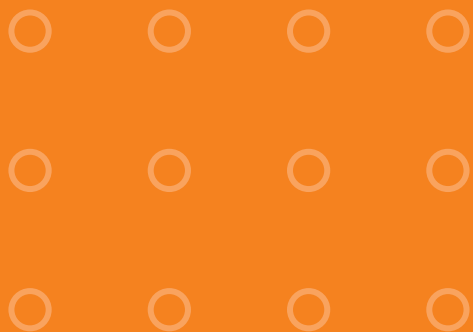

Supporting columns for modern and functional interior design

Planning the variable possible uses of a structure is one of the fundamental challenges in contemporary project architecture.

Open-plan “non-territorial office” landscaping concepts require flexible supply cable systems which are designed now to handle future media and working methods.

With OBO media columns you can meet all the technical and architectural requirements for modern communication cable routing systems and also actively influence the interior design. Media columns establish design accents in any office landscape and create order and thus security.

This ingenious, modular system allows free positioning of supply points close to the workstation. Later change of location is possible at any time, so it offers the greatest possible freedom to users and architects.





OBO media columns offer freedom of spatial mobility and ensure optimum form and effective functionality, particularly in open-plan offices and administrative buildings, but also around till points in department stores or in production shops.

OBO
BETTERMANN

Detail and perfection

Developed by people for people

The OBO media columns have been developed according to the latest technical and ergonomic knowledge. The high-quality workmanship of the profiles and the contemporary and durable aluminium provide the basis for a mature installation system.

Smooth-running and user-friendly adjusting elements and versatile accessories make installation and maintenance child's play. Positioning adapted to individual requirements and changes in the energy supply are thus determined by people, not by technology.

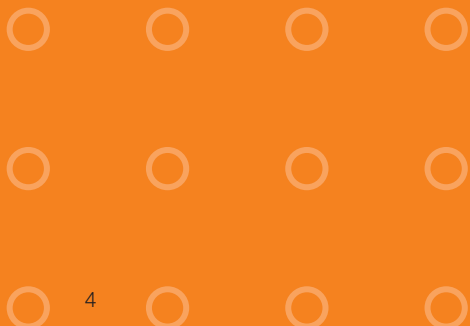



Functional and technically ingenious down to the smallest detail. The secure and well-ordered installation is made even simpler by system elements, such as partitions for shielding cables.

System and combination

As compatible as the information they carry

Versatile profile cross-sections and colours, variable height adjustment and floor fastenings, and extensive accessories offer both planners and users a system that can be combined with any architecture.

These columns can be adapted to almost any requirement and space situation; they fit in harmoniously and can accommodate all the usual installation devices and series without problems.

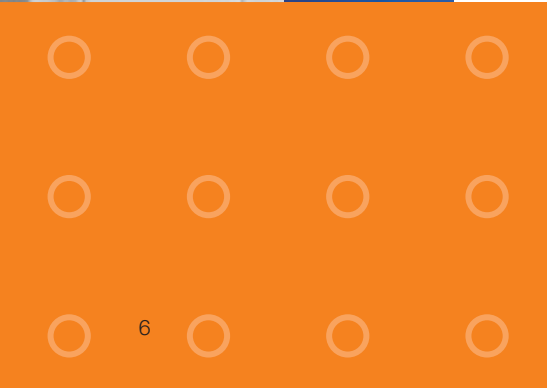

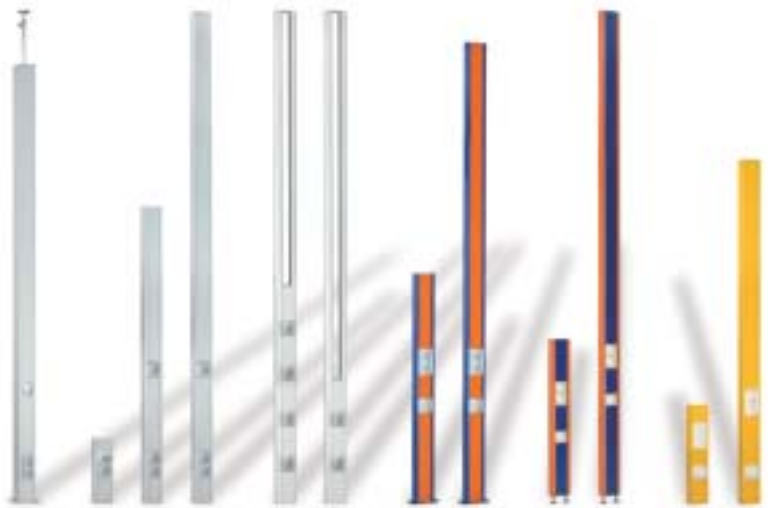
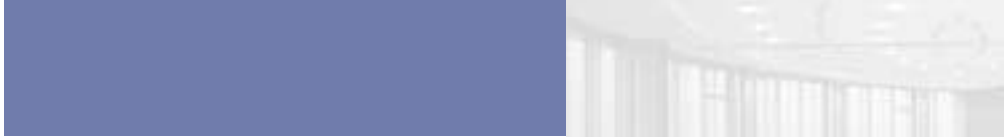

The colours, shapes and dimensions of this system offer the architect a virtually endless range of possibilities.



Versatile floor fastenings allow simple integration in any architecture.



A system that is easy to work with

The basis for this versatile system are five basic profiles which are available in almost all lengths, colours and combinations. The ingenious design ensures smooth planning and installation, whether with underfloor systems or cable ducts, or according to building specifications, such as suspended ceilings or exposed concrete. Free-standing or wall-mounted, the media columns provide the desired uses quickly, securely and aesthetically – for planners, installers and users.

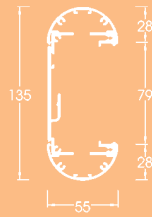

GMS 5513T

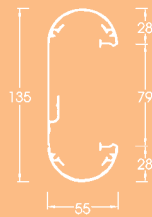

GMS 5513O



GMS 55110

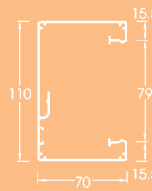

GMS 70110

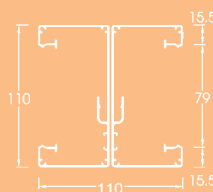

GMS 110110
GMS 11/25
GMS 11/50

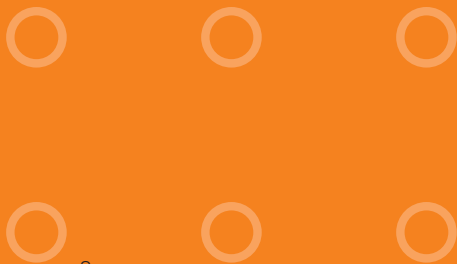

Simplest planning and installation, whether as a free-standing or wall-mounted column.



The various accessory modules allow perfect integration with suspended ceilings or also with exposed concrete. Interference-free cable entry is guaranteed from above, from below, from cable ducts or from underfloor systems.

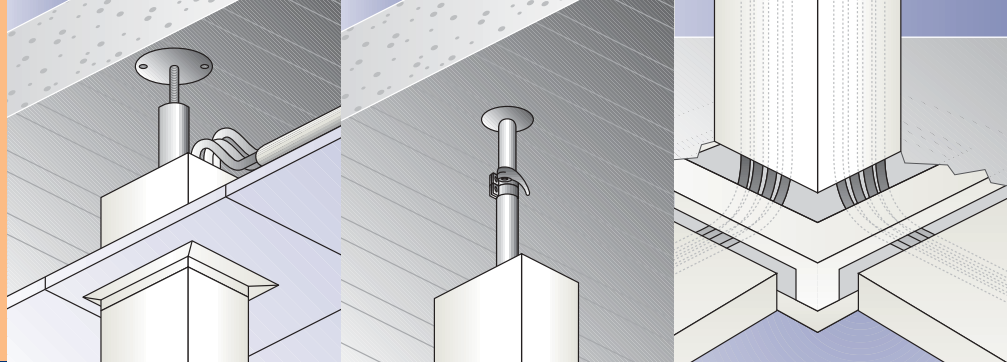

OBO media columns finally put an end to cable chaos and carry energy securely and tidily.



Floor-Ceiling Media Column

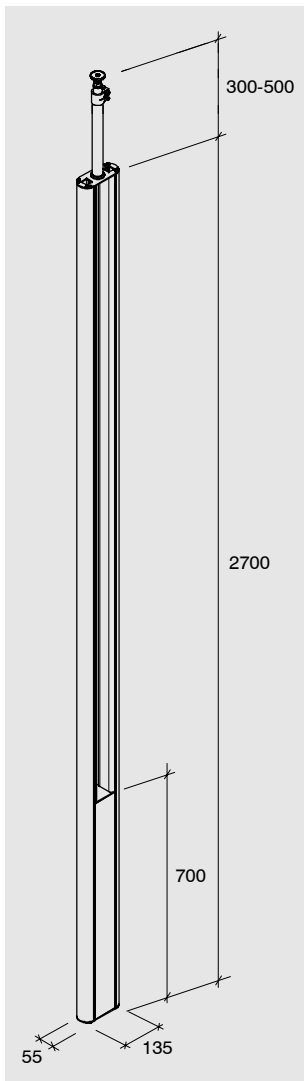

Floor-Ceiling Media Column

- Set consisting of:
- 1 single-duct column with floor fastening
overall length: 3000 mm-3200 mm
 - 1 ceiling fastening with stretching device
 - 1 duct installation profile
length: 700 mm
 - 1 aluminium lid
length: 700 mm

Type	Material	Weight kg/pc	Pack pc	Colour	Order no.
GMS 5513 T	aluminium	4.500	1	pure white *	6254220

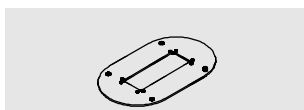

- Base plate**
with 30 mm visible edge and 4 fastening holes Ø 8.5 mm

Type	Material	Weight kg/pc	Pack pc	Colour	Order no.
GM 5513 BP	steel	0.400	1	pure white*	6254221

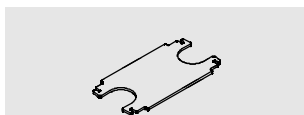

- Interim stabiliser**
for additional stiffening of the profiles

Type	Material	Weight kg/pc	Pack pc	Colour	Order no.
GM 5513 Z	steel	0.050	1	pure white*	6254222



- Fastening angle**
for wall fastening

Type	Material	Weight kg/pc	Pack pc	Colour	Order no.
GM 5513 BW	steel	0.050	1	pure white*	6254223



- Rubber pad**
for slippery floors in combination with the end piece supplied

Type	Material	Weight kg/pc	Pack pc	Colour	Order no.
GM 5513 GU	rubber	0.600	1	black	6254224

Floor-Ceiling Media Column



Accessory socket, single
(strain relief by cable tie or strain relief 2390/Z8)

Type	Material	Weight kg/pc	Pack pc	Colour	Order no.
GED-1	plastic	0.053	20	white	6257604



Accessory socket, single halogen-free

Type	Material	Weight kg/pc	Pack pc	Colour	Order no.
GED-1 HF	plastic	0.053	20	white	6257624



Earth cable
for GEA_GMS with termination sleeves

Type	Material	Weight kg/pc	Pack pc	Colour	Order no.
EDA 4	copper	0.012	20	green-yellow	6257602



Earthing terminal
for GEA_GMS

Type	Material	Weight kg/pc	Pack pc	Colour	Order no.
EDA KL	brass	0.011	40	natural	6257603

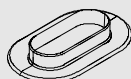

Ceiling anchor plate

Type	Material	Weight kg/pc	Pack pc	Colour	Order no.
WA 55135 O	plastic	0.500	1	pure white	6257590

Installation examples

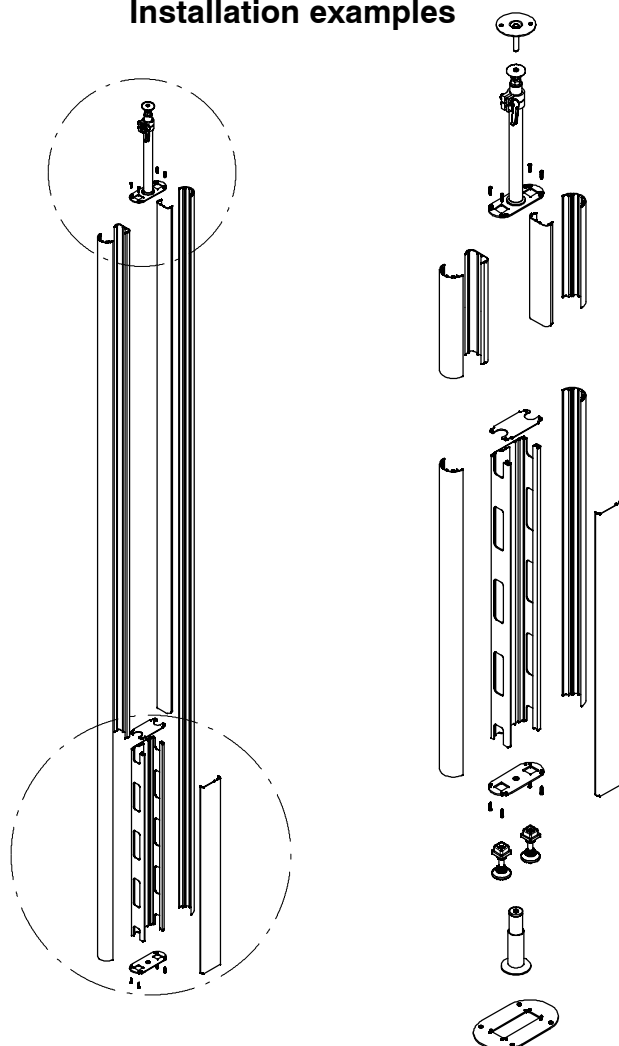

Floor-Ceiling Media Column

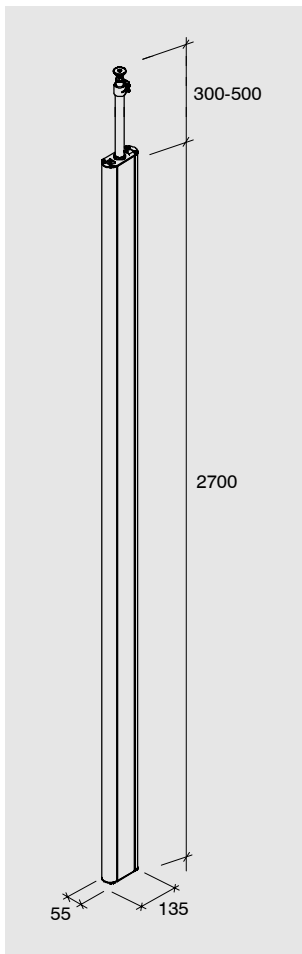

- Floor-Ceiling Media Column**
Set consisting of:
- 1 single-duct column with floor fastening overall length: 3000 mm-3200 mm
 - 1 ceiling fastening with stretching device
 - 1 aluminium lid length: 2700 mm

Type	Material	Weight kg/pc	Pack pc	Colour	Order no.
GMS 5513 O	aluminium	6.750		pure white*	6254230

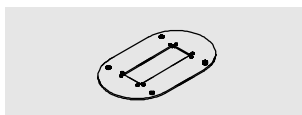

- Base plate**
with 30 mm visible edge and 4 fastening holes Ø 8.5 mm

Type	Material	Weight kg/pc	Pack pc	Colour	Order no.
GM 5513 BP	steel	0.400	1	pure white*	6254221

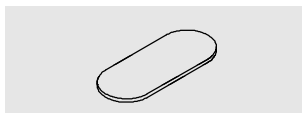

- Rubber pad**
for slippery floors in combination with the end piece supplied

Type	Material	Weight kg/pc	Pack pc	Colour	Order no.
GM 5513 GU	rubber	0.600	1	black	6254224

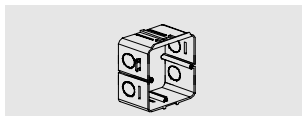

- Accessory socket, single**
(strain relief by cable tie or strain relief 2390/Z8)

Type	Material	Weight kg/pc	Pack pc	Colour	Order no.
GED-1	plastic	0.053	20	white	6257604

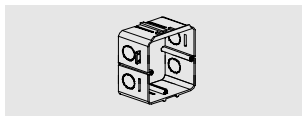

- Accessory socket, single halogen-free**

Type	Material	Weight kg/pc	Pack pc	Colour	Order no.
GED-1 HF	plastic	0.053	20	white	6257624



- Earth cable**
for GEA, GMS with termination sleeves

Type	Material	Weight kg/pc	Pack pc	Colour	Order no.
EDA 4	copper	0.012	20	green-yellow	6257602

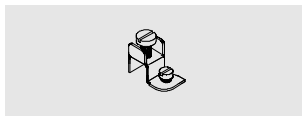

- Earthing terminal**
for GEA, GMS

Type	Material	Weight kg/pc	Pack pc	Colour	Order no.
EDA KL	brass	0.011	40	natural	6257603

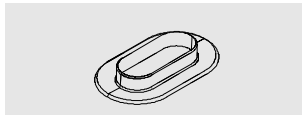

- Ceiling anchor plate**

Type	Material	Weight kg/pc	Pack pc	Colour	Order no.
WA 55135 O	plastic	0.500	1	pure white	6257590

Floor-Ceiling Media Column

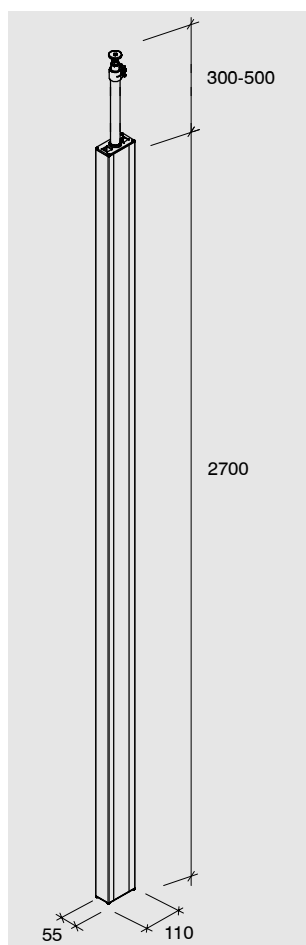

Floor-Ceiling Media Column

Set consisting of:
1 single-duct column with floor fastening
 overall length: 3000 mm-3200 mm
1 ceiling fastening with stretching device
1 aluminium lid
 length: 2700 mm

Type	Material	Weight kg/pc	Pack pc	Colour	Order no.
GMS 55110	aluminium	6.360	1	pure white*	6254240

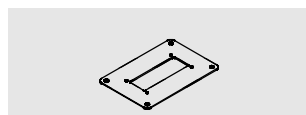

Base plate
 with 30 mm visible edge and 4 fastening holes Ø 8.5 mm

Type	Material	Weight kg/pc	Pack pc	Colour	Order no.
GM 5511 BP	steel	0.450	1	pure white*	6254241

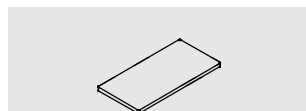

Rubber pad
 for slippery floors in combination with the end piece supplied

Type	Material	Weight kg/pc	Pack pc	Colour	Order no.
GM 5511 GU	rubber	0.050	1	black	6254244

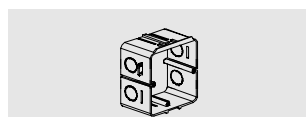

Accessory socket, single
 (strain relief by cable tie or strain relief 2390/Z8)

Type	Material	Weight kg/pc	Pack pc	Colour	Order no.
GED-1	plastic	0.053	20	white	6257604

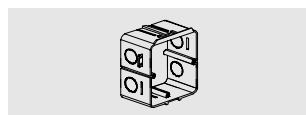

Accessory socket, single halogen-free
 (strain relief by cable tie or Z8)

Type	Material	Weight kg/pc	Pack pc	Colour	Order no.
GED-1 HF	plastic	0.053	20	white	6257624



Earth cable
 for GEA_GMS with termination sleeves

Type	Material	Weight kg/pc	Pack pc	Colour	Order no.
EDA 4	copper	0.012	20	green-yellow	6257602

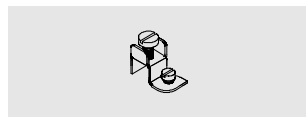

Earthing terminal
 for GEA_GMS

Type	Material	Weight kg/pc	Pack pc	Colour	Order no.
EDA KL	brass	0.011	40	natural	6257603

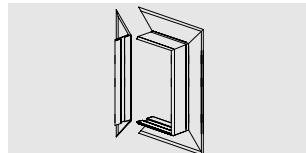

Ceiling anchor plate

Type	Material	Weight kg/pc	Pack pc	Colour	Order no.
WA G5511 A	aluminium	0.120	1	pure white	6257591

Floor-Ceiling Media Column

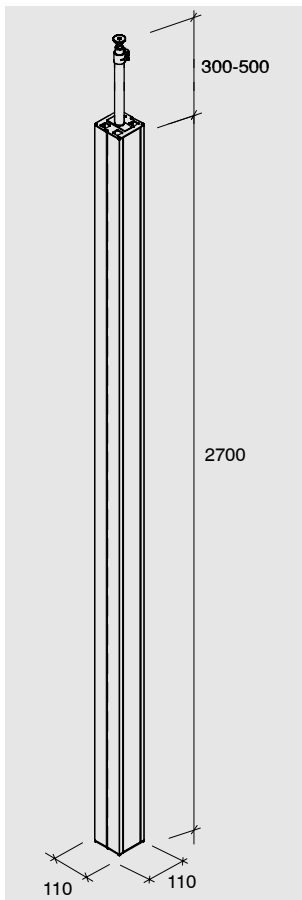

Floor-Ceiling Media Column

- Set consisting of:
- 1 double-duct column with floor fastening
overall length: 3000 mm-3200 mm
 - 1 ceiling fastening with stretching device
 - 1 aluminium lid
length: 2700 mm

Type	Material	Weight kg/pc	Pack pc	Colour	Order no.
GMS 110110	aluminium	11.700	1	pure white *	6254250

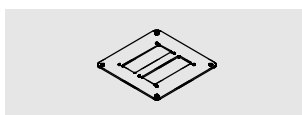

- Base plate**
with 30 mm visible edge and 4 fastening holes Ø 8.5 mm

Type	Material	Weight kg/pc	Pack pc	Colour	Order no.
GM 1111 BP	steel	0.780	1	pure white *	6254251

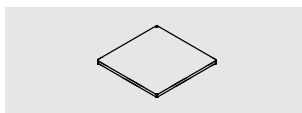

- Rubber pad**
for slippery floors in combination with the end piece supplied

Type	Material	Weight kg/pc	Pack pc	Colour	Order no.
GM 1111 GU	rubber	0.730	1	black	6254254

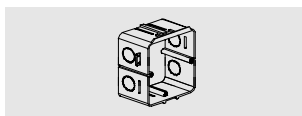

- Accessory socket, single**
(strain relief by cable tie or strain relief 2390/Z8)

Type	Material	Weight kg/pc	Pack pc	Colour	Order no.
GED-1	plastic	0.053	20	white	6257604

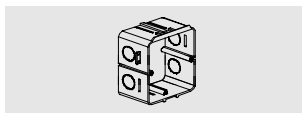

- Accessory socket, single halogen-free**

Type	Material	Weight kg/pc	Pack pc	Colour	Order no.
GED-1 HF	plastic	0.053	20	white	6257624



- Earth cable**
for GEA, GMS with termination sleeves

Type	Material	Weight kg/pc	Pack pc	Colour	Order no.
EDA 4	copper	0.012	20	green-yellow	6257602

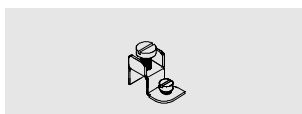

- Earthing terminal**
for GEA, GMS

Type	Material	Weight kg/pc	Pack pc	Colour	Order no.
EDA KL	brass	0.011	40	natural	6257603

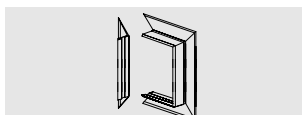

- Ceiling anchor plate**

Type	Material	Weight kg/pc	Pack pc	Colour	Order no.
WAG 1111A	aluminium	0.170	1	pure white *	6257593

Floor-Ceiling Media Column

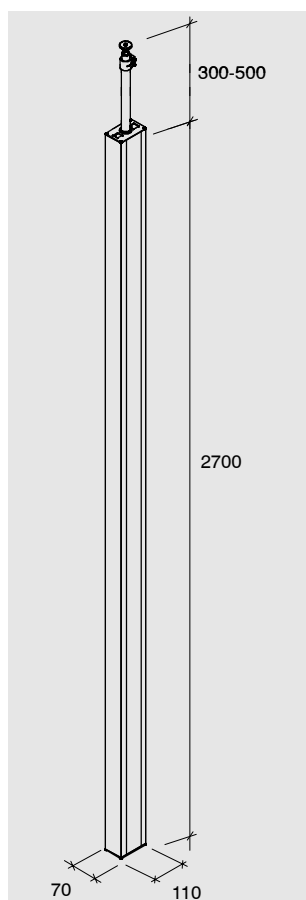

Floor-Ceiling Media Column

Set consisting of:
 1 single-duct column with floor fastening
 overall length: 3000 mm-3200 mm
 1 ceiling fastening with stretching device
 1 aluminium lid
 length: 2700 mm

Type	Material	Weight kg/pc	Pack pc	Colour	Order no.
GMS 70110	aluminium	6.600	1	pure white *	6254260

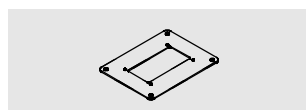

Base plate
 with 30 mm visible edge and 4 fastening holes Ø 8.5 mm

Type	Material	Weight kg/pc	Pack pc	Colour	Order no.
GM 7011 BP	steel	0.580	1	pure white *	6254261

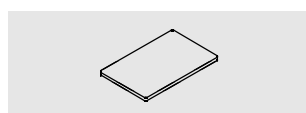

Rubber pad
 for slippery floors in combination with the end piece supplied

Type	Material	Weight kg/pc	Pack pc	Colour	Order no.
GM 7011 GU	rubber	0.060	1	black	6254264

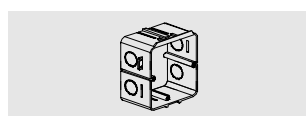

Accessory socket, single
 (strain relief by cable tie or strain relief 2390/Z8)

Type	Material	Weight kg/pc	Pack pc	Colour	Order no.
GED-1	plastic	0.053	20	white	6257604

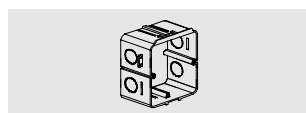

Accessory socket, single halogen-free

Type	Material	Weight kg/pc	Pack pc	Colour	Order no.
GED-1 HF	plastic	0.053	20	white	6257624



Earth cable
 for GEA_GMS with termination sleeves

Type	Material	Weight kg/pc	Pack pc	Colour	Order no.
EDA 4	copper	0.012	20	green-yellow	6257602

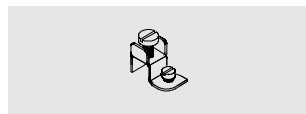

Earthing terminal
 for GEA_GMS

Type	Material	Weight kg/pc	Pack pc	Colour	Order no.
EDA KL	brass	0.011	40	natural	6257603

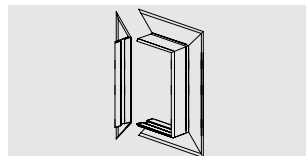

Ceiling anchor plate

Type	Material	Weight kg/pc	Pack pc	Colour	Order no.
WAG 7011A	aluminium	0.130	1	pure white *	6257595

Accessories Floor-Ceiling Media Columns

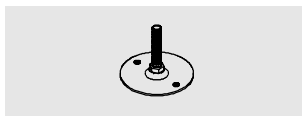

Ceiling fastening
to be screwed in combination
with stretching device

Type	Material	Weight kg/pc	Pack pc	Colour	Order no.
GMS DB	steel	0.058	1	galvanised	6254900

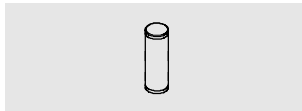

Spacer for floor section
for fitting to end pieces

Type	Material	Weight kg/pc	Pack pc	Colour	Order no.
GMS AH	aluminium	0.070	1	natural anod.	6254901

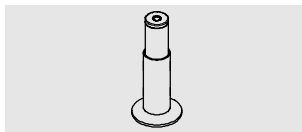

Exclusive foot for floor section
for fitting to end pieces supplied

Type	Material	Weight kg/pc	Pack pc	Colour	Order no.
GMS SFM	metal	0.150	1	natural	6254902

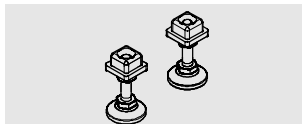

Classic feet for floor section
for fitting to end pieces supplied
(2 items per set)

Type	Material	Weight kg/pc	Pack set	Colour	Order no.
GMS SF	metal	0.040	1	chrome/black	6254903

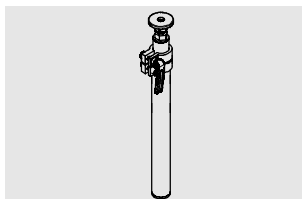

Telescopic stretching device
300-500 mm

Type	Material	Weight kg/pc	Pack pc	Colour	Order no.
GMS TK	aluminium	0.300	1	natural anod.	6254904

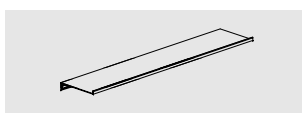

Partition
single
stock length: 1000 mm

Type	Material	Weight kg/m	Pack m	Colour	Order no.
GA TW 55-1	steel	0.540	15	galvanised	6257356

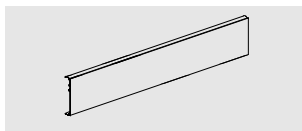

Lid
80 mm
stock length: 2000 mm

Type	Material	Weight kg/m	Pack m	Colour	Order no.
GA D80	aluminium	0.420	16	pure white	6257050
GK D80	plastic	0.390	16	pure white	6257080



Strain relief Z8
for GED-1
GED-2

Type	Material	Weight kg/pc	Pack pc	Colour	Order no.
2390/Z8	plastic	0.005	50	grey	6270727

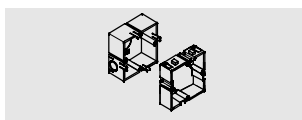

**Accessory socket for data
technology with removable
accessory case**
* can only be fitted without accessory
case in GMS with 55 mm depth

Type	Material	Weight kg/pc	Pack pc	Colour	Order no.
GED-1D	plastic	0.042	20	white	6257606

Floor Media Column

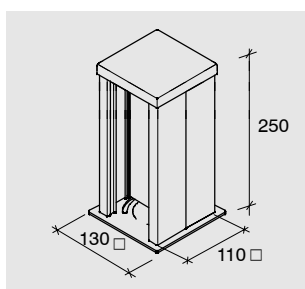

Media column
Empty, can be fitted with standard commercial accessories (power socket, telephone, etc.) **max. 4 accessories**
 Can be fastened directly to the floor or underfloor systems. Lid and accessory socket should be ordered separately.
 Special sizes possible on request.

Type	Material	Weight kg/pc	Pack pc	Colour	Order no.
GMS 11/25	aluminium	0.638	1	pure white	6254200

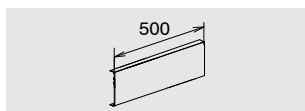

Lid

Type	Material	Weight kg/pc	Pack pc	Colour	Order no.
GK D80/5	plastic	0.355	1	pure white	6257081

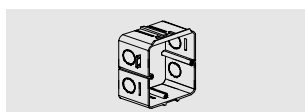

Accessory socket, single
 (strain relief by cable tie or strain relief 2390/Z8)

Type	Material	Weight kg/pc	Pack pc	Colour	Order no.
GED-1	plastic	0.053	20	pure white	6257604

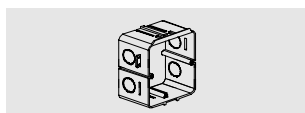

Accessory socket, single halogen-free

Type	Material	Weight kg/pc	Pack pc	Colour	Order no.
GED-1 HF	plastic	0.053	20	white	6257624

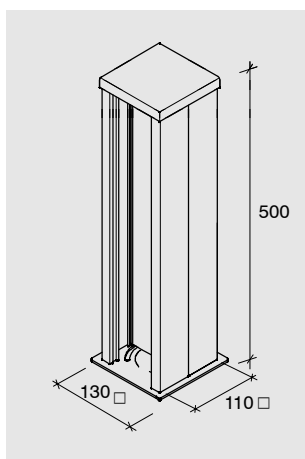

Media column
Empty, can be fitted with standard commercial accessories (power socket, telephone, etc.) **max. 8 accessories**
 Can be fastened directly to the floor or underfloor systems. Lid and accessory socket should be ordered separately.
 Special sizes possible on request.

Type	Material	Weight kg/pc	Pack pc	Colour	Order no.
GMS 11/50	aluminium	1.140	1	pure white	6254210

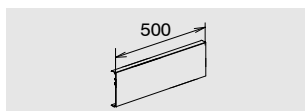

Lid

Type	Material	Weight kg/pc	Pack pc	Colour	Order no.
GK D80/5	plastic	0.355	1	pure white	6257081

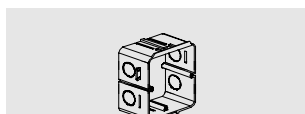

Accessory socket, single
 (strain relief by cable tie or strain relief 2390/Z8)

Type	Material	Weight kg/pc	Pack pc	Colour	Order no.
GED-1	plastic	0.053	20	pure white	6257604

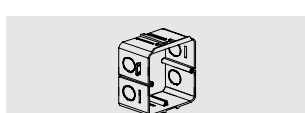

Accessory socket, single halogen-free

Type	Material	Weight kg/pc	Pack pc	Colour	Order no.
GED-1 HF	plastic	0.053	20	white	6257624

Long live variety

OBO underfloor systems for applications in all fields

OBO underfloor systems consist of floor ducts of various shapes and sizes and the associated connection sockets flush with the floor to equip workstations with power and light current and for connection to data and communications networks. An interesting alternative to underfloor connection sockets is offered by OBO media columns, which provide par-

ticularly quick and easy access to the sockets at all times.

OBO underfloor systems are harmonised with the various floor types and are divided into three categories:

- ▶ **Carpeted floors (dry care)**
- ▶ **Hard floors (dry care)**
- ▶ **Hard floors (wet care)**





OBO's systems at a glance



VBS. Connection and fastening systems

Connection systems

Fastening systems

Beam clamp systems

Rail systems

Screw-in and knock-in systems



TBS. Transient voltage and lightning protection systems

Surge protection systems

Equipotential bonding systems

Earthing systems

Lightning protection systems

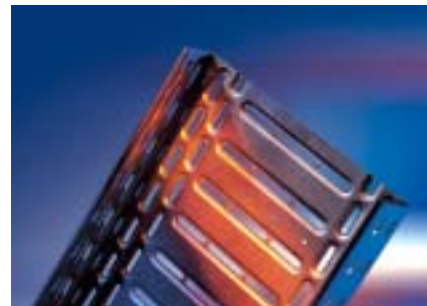

KTS. Cable support systems

Mounting systems

Cable tray systems

Mesh cable tray systems

Cable ladder systems

Vertical ladder systems

Modular systems

Luminaire support systems

Distribution boxes

Stainless-steel components

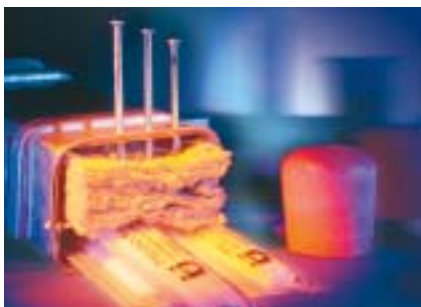

BSS. Fire protection systems

Cable insulation

Fire protection ducts

Function maintenance



LFS. Cable routing systems

Installation duct systems

Skirting duct systems

IBIS Integral

Media columns

Integrated device systems



UFS. Underfloor systems

Underfloor installation systems

ISO A duct system

Cavity and false floor systems

OBO BETTERMANN GmbH & Co.
 P.O. Box 1120 · 58694 Menden · Germany
 Tel. +49 (0)23 73/89-0 · Fax +49 (0)23 73/89-238
 E-mail: info@obo.de · www.obo-bettermann.com

Central technical hotline
 Tel. +49 (0)23 73/89-1500
 Fax +49 (0)23 73/89-1550
 E-mail: hotline@obo.de

OBO
BETTERMANN