

Catalogue 2010/2011



Product Innovations

THINK CONNECTED.



At OBO, variety and networked thinking belong together. For us, the further processing and improvement of our products is a continuous, never-ending process.





We are again proud to be able to present you with our Product Innovations Catalogue – with a wealth of user-friendly, practical solutions from our seven product units.

Matthias Gerstberger, Divisional Manager, Innovation and Marketing

Contents

| | | |
|---|--|-----|
|  | VBS Connection and fastening systems | 5 |
|  | TBS Transient and lightning protection systems | 31 |
|  | KTS Cable support systems | 59 |
|  | BSS Fire protection systems | 73 |
|  | LFS Cable routing systems | 79 |
|  | EGS Device systems | 103 |
|  | UFS Underfloor systems | 119 |

Contents, EGS Product Innovations

| | | | |
|---|--|----------------------|-----|
|  | Modul 45connect sockets | Information Products | |
|  | Combined: Consolidation Point | Information Products | 110 |
|  | New generation of Deskboxes | Information Products | 112 |
|  | Universal data technology support for Modul 45 | Information Products | 115 |



Modul 45connect – connections made easy

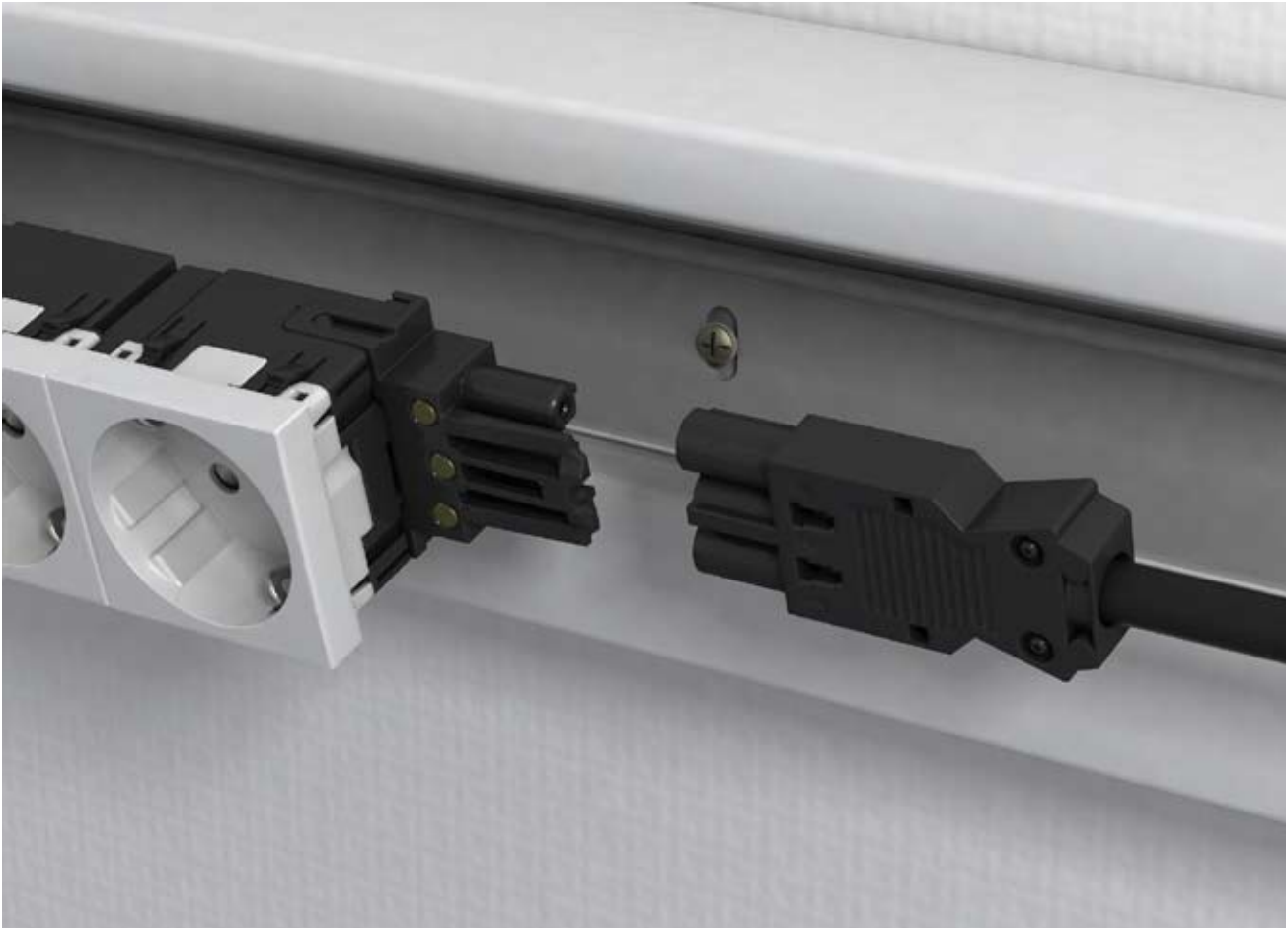

The benefits of the new Modul 45connect systems are clearly visible: Quick installation, increased safety, flexibility and longevity.

Sockets and accessories of the Modul 45connect series now permit even faster installations. There is no longer a need to connect the individual wires. The power connection is made simply using plug-in connection adapters.

Suitable adapters

The connection between Wieland connectors and the individual socket is made using various connection adapters: The straight connector and socket adapters and the U-shaped connector adapter. The protective contact and earthing pin sockets are available in double and triple versions.

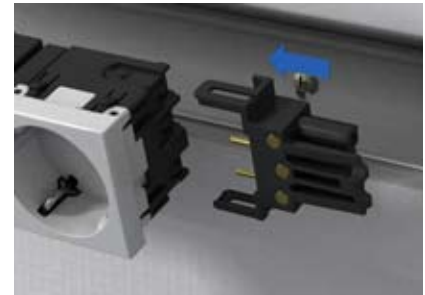

Varied applications

The most recent addition to OBO's large Modul 45 family was specially designed for use in the cable routing systems with 45 and 80 mm system openings, and for device installation systems for raised floors and open, screed-flush duct systems. OBO designed the surge protection module with supports for Modul 45connect especially for use in underfloor systems.



Combined: Consolidation Point

With a supply point under the ceiling or in a raised floor, OBO can ensure flexible use of power and data technology. All the cables, for example for a service pole, can be installed directly on the handy box, the Consolidation Point, and then run directly to the workplace. The complete unit contains all the parts required for standard installation. Up to eight Modul45 devices fit in the compact housing. The standard separation of heavy current and data technology is carried out using the cover hood contained in the scope of supply.



New generation of Deskboxes



High-quality material, slim design and variable installation options: The new generation of OBO Deskboxes can prove itself both in the standard and special versions through its appearance and versatility.

The box, made of high-quality aluminium, can be positioned anywhere on the workplace, thus offering a range of design options.

Pre-terminated

OBO can offer various pre-terminated and ready-for-connection versions of the Deskbox for standard workplace requirements – including network connection cables, of course.

Individual

Alternatively, the train profile can be equipped according to customer requirements. A comprehensive range of installation units and accessories are available for this. These range from country-specific sockets, through data technology

and protection modules, right up to multimedia connections. The individual Deskbox is then supplied as a tested and ready-to-connect unit with a network connection cable.





Universal data technology support for Modul 45

At OBO, the Universal data technology support for Modul 45 has a “supporting” role to play. The sloping and straight versions are suitable for horizontal and vertical system installation.

All standard data modules can be integrated quickly and simply in the support. And the Universal data technology support can do even more: Its integrated dust protection flaps protect the electronics against the ingress of dirt and its labelling panels allow exact assignment of the module components.



Modul 45connect sockets



Protective contact socket 33°

| Type | Colour | Pack. | Weight | Item No. |
|---------------|-----------------|-------|-------------|-----------|
| | | pcs | kg/100 pcs. | |
| SKS-DS3 RW2 | Pure white | 10 | 8.240 | 6117 07 4 |
| SKS-DS3 ROR2 | Orange | 10 | 8.240 | 6117 07 6 |
| SKS-DS3 MZGN2 | Mint green | 10 | 8.240 | 6117 07 8 |
| SKS-DS3 SRO2 | Signal red | 10 | 8.240 | 6117 08 0 |
| SKS-DS3 SWGR2 | Black-grey | 10 | 8.240 | 6117 08 1 |
| SKS-DS3 AL2 | Aluminium paint | 10 | 8.240 | 6117 08 2 |

Power socket with side connection double 33°, with increased touch protection with screwless terminals, 2-pin, 16 A, 250 V~, with connection terminals to IEC 60884-1.

| Type | Colour | Pack. | Weight | Item No. |
|---------------|-----------------|-------|-------------|-----------|
| | | pcs | kg/100 pcs. | |
| SKS-DS3 RW3 | Pure white | 4 | 11.960 | 6119 85 0 |
| SKS-DS3 ROR3 | Orange | 4 | 11.960 | 6119 85 2 |
| SKS-DS3 MZGN3 | Mint green | 4 | 11.960 | 6119 85 4 |
| SKS-DS3 SRO3 | Signal red | 4 | 11.960 | 6119 85 6 |
| SKS-DS3 SWGR3 | Black-grey | 4 | 11.960 | 6119 85 8 |
| SKS-DS3 AL3 | Aluminium paint | 4 | 11.960 | 6119 86 0 |

Power socket with side connection triple 33°, with increased touch protection with screwless terminals, 2-pin, 16 A, 250 V~, with connection terminals to IEC 60884-1.

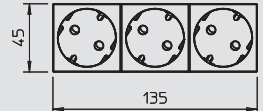
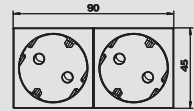
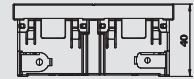

Socket with earthing pin 33°

| Type | Colour | Pack. | Weight | Item No. |
|---------------|-----------------|-------|-------------|-----------|
| | | pcs | kg/100 pcs. | |
| SKS-FS3 RW2 | Pure white | 10 | 7.880 | 6119 86 8 |
| SKS-FS3 ROR2 | Orange | 10 | 7.880 | 6119 87 0 |
| SKS-FS3 MZGN2 | Mint green | 10 | 7.880 | 6119 87 2 |
| SKS-FS3 SRO2 | Signal red | 10 | 7.880 | 6119 87 4 |
| SKS-FS3 SWGR2 | Black-grey | 10 | 7.880 | 6119 87 6 |
| SKS-FS3 AL2 | Aluminium paint | 10 | 7.880 | 6119 87 8 |

Socket with earthing pin with side connection double 33°, with increased touch protection with screwless terminals, 2-pin, 16 A, 250 V~, with connection terminals to IEC 60884-1.

| Type | Colour | Pack. | Weight | Item No. |
|---------------|-----------------|-------|-------------|-----------|
| | | pcs | kg/100 pcs. | |
| SKS-FS3 RW3 | Pure white | 4 | 11.600 | 6119 88 0 |
| SKS-FS3 ROR3 | Orange | 4 | 11.600 | 6119 88 2 |
| SKS-FS3 MZGN3 | Mint green | 4 | 11.600 | 6119 88 4 |
| SKS-FS3 SRO3 | Signal red | 4 | 11.600 | 6119 88 6 |
| SKS-FS3 SWGR3 | Black-grey | 4 | 11.600 | 6119 88 8 |
| SKS-FS3 AL3 | Aluminium paint | 4 | 11.600 | 6119 89 0 |

Socket with earthing pin with side connection triple 33°, with increased touch protection with screwless terminals, 2-pin, 16 A 250 V~, with connection terminals to IEC 60884-1.

With screwless terminals, 2-pole, 16 A 250 V~, with connection terminals to IEC 60884-1.

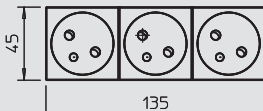
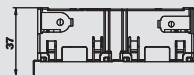
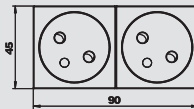

Connection adapter, straight, connector part

| Type | Colour | Pack. | Weight | Item No. |
|---------------|--------|-------|-------------|-----------|
| | | pcs | kg/100 pcs. | |
| STA-SKS S1 SW | Black | 10 | 1.200 | 6117 19 2 |
| STA-SKS S1 W | White | 10 | 1.200 | 6117 19 3 |

Connector part adapter, straight, for connection to an SKS-DS or SKS-FS socket from the side, for VL extension cable with Wieland connector GST 18i 3p.

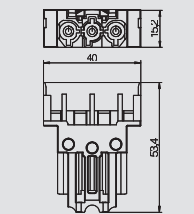

Connection adapter, straight, socket part

| Type | Colour | Pack. | Weight | Item No. |
|---------------|--------|-------|-------------|-----------|
| | | pcs | kg/100 pcs. | |
| BTA-SKS S1 SW | Black | 10 | 1.200 | 6117 19 0 |
| BTA-SKS S1 W | White | 10 | 1.200 | 6117 19 1 |

Socket part adapter, straight, for connection to an SKS-DS or SKS-FS socket from the side, for VL extension cable with Wieland connector GST 18i 3p.

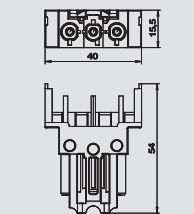

Connection adapter, U-shaped, connector part

| Type | Colour | Pack. | Weight | Item No. |
|----------------|--------|-------|-------------|-----------|
| | | pcs | kg/100 pcs. | |
| STA-SKS SU1 SW | Black | 10 | 1.190 | 6117 19 6 |
| STA-SKS SU1 W | White | 10 | 1.190 | 6117 19 7 |

Connector part adapter, U-shaped, for connection to an SKS-DS or SKS-FS socket from the side, for VL extension cable with Wieland connector GST 18i 3p.

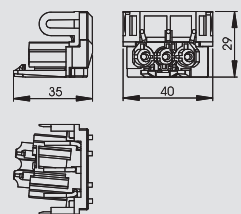

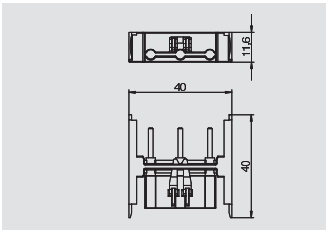

Connection adapter

| Type | Colour | Pack. | Weight | Item No. |
|-----------------|--------------|-------|-------------|------------------|
| | | pcs | kg/100 pcs. | |
| VB-SKS S | Black | 10 | 0.590 | 6117 19 8 |

Connection adapter for combining SKS-DS or SKS-FS sockets.

Note: Socket combinations with two connection adapters at most are permitted.

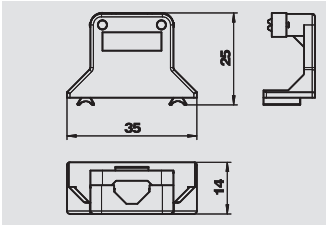

Strain relief

| Type | Colour | Pack. | Weight | Item No. |
|---------------|--------------|-------|-------------|------------------|
| | | pcs | kg/100 pcs. | |
| ZL-SKS | Cream | 10 | 0.467 | 6117 20 5 |

Strain relief for 0° power socket, socket with 0° earthing pin and Modul 45connect sockets, connectable at side. For fastening a 3-wire cable, max. Ø 10 mm.



Consolidation Point



Empty housing

| Type | Pack. | Weight | Item No. |
|-------------------|-------|-------------|------------------|
| | pcs | kg/100 pcs. | |
| CP45-LG 8A | 1 | 190.000 | 6108 03 7 |

Consolidation Point empty housing for the installation of 4 Modul 45 accessories (expandable to max. eight Modul 45 accessories), consisting of housing base and cover, a cover hood to separate data technology and heavy current, two support plates for the installation of two Modul 45 accessories each, two blanking plates, two cable glands V-TEC M25 and a protective conductor connection bracket.

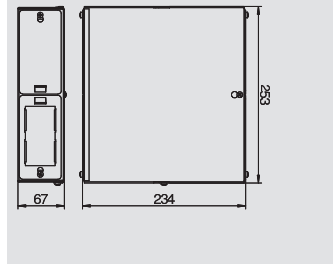

Support plate Modul 45

| Type | Pack. | Weight | Item No. |
|------------------|-------|-------------|------------------|
| | pcs | kg/100 pcs. | |
| CP45-TP M | 1 | 4.200 | 6108 03 9 |

Support plate to accept two Modul 45 devices in a Consolidation Point housing.

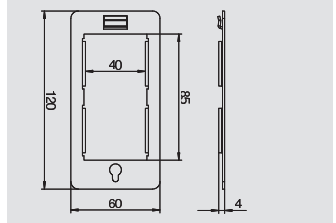

Support plate cable outlet

| Type | Pack. | Weight | Item No. |
|-------------------|-------|-------------|------------------|
| | pcs | kg/100 pcs. | |
| CP45-TP KE | 1 | 8.800 | 6108 04 0 |

Support plate for cable insertion into the Consolidation Point housing.

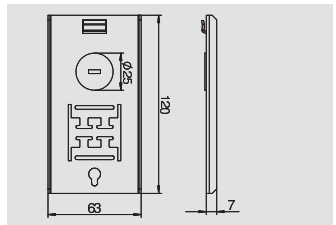

Blind plate

| Type | Pack. | Weight | Item No. |
|----------------|-------|-------------|------------------|
| | pcs | kg/100 pcs. | |
| CP45-BP | 1 | 8.000 | 6108 04 2 |

Blanking plate for closing off a mounting opening on a Consolidation Point housing.

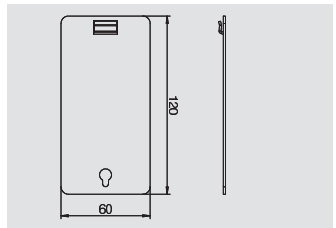

Terminal strip

| Type | Colour | Pack. | Weight | Item No. |
|----------------|--------|-------|-------------|------------------|
| | | pcs | kg/100 pcs. | |
| CP45-KL | Black | 1 | 2.000 | 6108 04 3 |

Screwless terminal strip with locking foot, 5-pin for a cable cross-section of 0.5–4 mm².

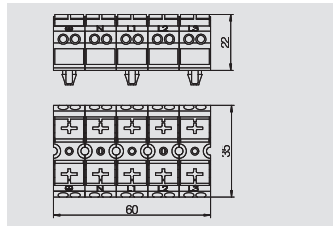

Energy distributor with plug connection

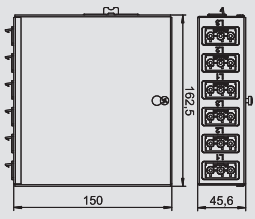

| Type | Pack. | Weight | Item No. |
|------------------|-------|-------------|------------------|
| | pcs | kg/100 pcs. | |
| UVS-6W2SA | 1 | 79.000 | 6108 01 4 |

Energy distributor for heavy current technology with plug connection, equipped and pre-wired.

Input: One rotary current circuit using a self-locking connector, 5 -pin, type GST18i (connector part).
 Output: Six self-locking connectors, 3-pin, in white, 16 A, type GST18i (socket part: 2 x L1, 2 x L2, 2 x L3).
 Internal wiring: PVC non-sheathed cable H07V-U2.5.

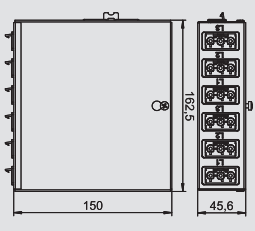

| Type | Pack. | Weight | Item No. |
|------------------|-------|-------------|------------------|
| | pcs | kg/100 pcs. | |
| UVS-6S2SA | 1 | 79.000 | 6108 01 2 |

Energy distributor for heavy current technology with plug connection, equipped and pre-wired.

Input: One rotary current circuit using a self-locking connector, 5 -pin, type GST18i (connector part).
 Output: Six self-locking connectors, 3-pin, in black, 16 A, type GST18i (socket part: 2 x L1, 2 x L2, 2 x L3).
 Internal wiring: PVC non-sheathed cable H07V-U2.5.

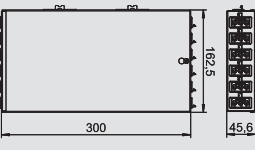

| Type | Pack. | Weight | Item No. |
|--------------------|-------|-------------|------------------|
| | pcs | kg/100 pcs. | |
| UVS-6S6W2SA | 1 | 140.000 | 6108 01 6 |

Energy distributor for heavy current technology with plug connection, equipped and pre-wired.

Input: Two rotary current circuits using self-locking connectors, 5 -pin, type GST18i (connector part).
 Output: Twelve self-locking connectors, 3-pin, in white (6x) and black (6x), 16 A, type GST18i (socket part: 2 x L1, 2 x L2, 2 x L3 for each rotary current circuit).
 Internal wiring: PVC non-sheathed cable H07V-U2.5.



New Deskbox



Deskbox with 3 sockets

| Type | Version | Pack. | Weight | Item No. |
|-------------------|--------------------------|-------|-------------|------------------|
| | | pcs | kg/100 pcs. | |
| DB-5A3 D3S | Housing, silver anodised | 1 | 0.000 | 6116 93 0 |

Ready-for-connection Deskbox with connection cable, cable outlet on the left housing cover, freely erectable.

Equipment:

- Three protection contact sockets in 0° connection direction, incl. 3.0 m power cable with angular connector CEE 7/7.



| Type | Version | Pack. | Weight | Item No. |
|-------------------|--------------------------|-------|-------------|------------------|
| | | pcs | kg/100 pcs. | |
| DB-1B3 D3S | Housing, silver anodised | 1 | 0.000 | 6116 93 6 |

Ready-for-connection Deskbox with connection cable, cable outlet at the bottom left of the profile with a fastening clamp for tabletop thicknesses of 8 to 40 mm.

Equipment:

- Three protective contact sockets in 0° connection direction, incl. 3.0 m power cable with angular connector CEE 7/7.



| Type | Version | Pack. | Weight | Item No. |
|-------------------|--------------------------|-------|-------------|------------------|
| | | pcs | kg/100 pcs. | |
| DB-0B3 D3S | Housing, silver anodised | 1 | 0.000 | 6116 93 9 |

Ready-for-connection Deskbox with connection cable, cable outlet at the bottom left of the profile, without fastening material, combinable with the fastening solutions listed in the accessories.

Equipment:

- Three protection contact sockets in 0° connection direction, incl. 3.0 m power cable with angular connector CEE 7/7.

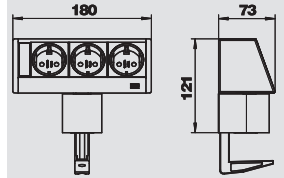
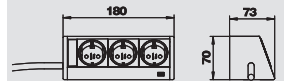

Deskbox with 3 sockets and data technology connection

| Type | Colour | Pack. | Weight | Item No. |
|---------------------|-----------|-------|-------------|------------------|
| | | pcs | kg/100 pcs. | |
| DB-5A3 D3S2K | Aluminium | 1 | 0.000 | 6116 93 3 |

Ready-for-connection Deskbox with connection cable, cable outlet on the left housing cover, freely erectable.

Equipment:

- Three protection contact sockets in 0° connection direction, incl. 3.0 m power cable with angular connector CEE 7/7.
- Two data technology couplings RJ45 to RJ45, switched 1:1, Cat. 6 shielded.



| Type | Version | Pack. | Weight | Item No. |
|---------------------|--------------------------|-------|-------------|------------------|
| | | pcs | kg/100 pcs. | |
| DB-1B3 D3S2K | Housing, silver anodised | 1 | 0.000 | 6116 94 2 |

Ready-for-connection Deskbox with connection cable, cable outlet at the bottom left of the profile with two fastening clamps for tabletop thicknesses of 8 to 40 mm.

Equipment:

- Three protective contact sockets in 0° connection direction, incl. 3.0 m power cable with angular connector CEE 7/7.
- Two data technology couplings RJ45 to RJ45, switched 1:1, Cat. 6 shielded.



| Type | Version | Pack. | Weight | Item No. |
|---------------------|--------------------------|-------|-------------|------------------|
| | | pcs | kg/100 pcs. | |
| DB-0B3 D3S2K | Housing, silver anodised | 1 | 0.000 | 6116 94 5 |

Ready-for-connection Deskbox with connection cable, cable outlet at the bottom left of the profile, without fastening material, combinable with the fastening solutions listed in the accessories.

Equipment:

- Three protection contact sockets in 0° connection direction, incl. 3.0 m power cable with angular connector CEE 7/7.
- Two data technology couplings RJ45 to RJ45, switched 1:1, Cat. 6 shielded.

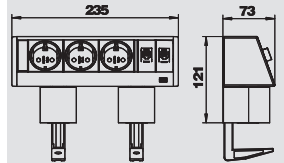
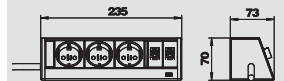

Deskbox with 1+4 sockets

| Type | Version | Pack. | Weight | Item No. |
|---------------------|--------------------------|-------|-------------|------------------|
| | | pcs | kg/100 pcs. | |
| DB-1B3 D1.4S | Housing, silver anodised | 1 | 0.000 | 6116 94 8 |

Ready-for-connection Deskbox with connection cable, cable outlet at the bottom left of the profile with two fastening clamps for tabletop thicknesses of 8 to 40 mm.

Equipment:

- Five protective contact sockets in 0° connection direction, of which one socket is for continuous current and four sockets can be switched using a one-way switch (lit in blue), incl. 3.0 m power cable with angular connector CEE 7/7.

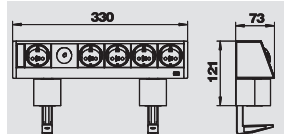

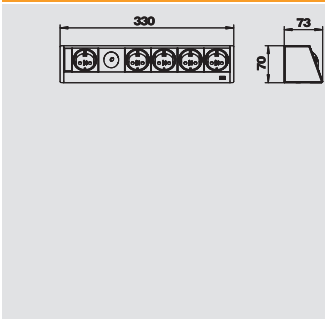

Deskbox with 1+4 sockets

| Type | Version | Pack. | Weight | Item No. |
|---------------------|--------------------------|-------|-------------|------------------|
| | | pcs | kg/100 pcs. | |
| DB-0B3 D1.4S | Housing, silver anodised | 1 | 0.000 | 6116 95 1 |

Ready-for-connection Deskbox with connection cable, cable outlet at the bottom left of the profile, without fastening material, combinable with the fastening solutions listed in the accessories.

Equipment:

- Five protective contact sockets in 0° connection direction, of which one socket is for continuous current and four sockets can be switched using a one-way switch (lit in blue), incl. 3.0 m power cable with angular connector CEE 7/7.

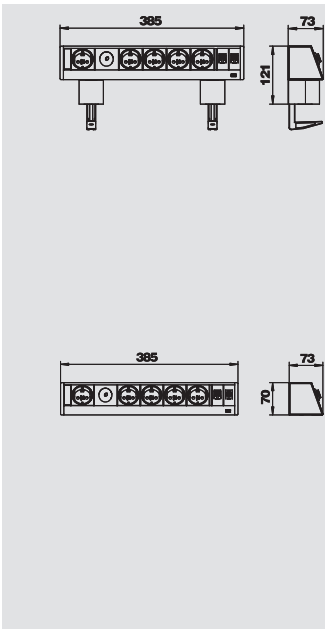

Deskbox with 1+4 sockets and data technology connection

| Type | Version | Pack. | Weight | Item No. |
|-----------------------|--------------------------|-------|-------------|------------------|
| | | pcs | kg/100 pcs. | |
| DB-1B3 D1.4S2K | Housing, silver anodised | 1 | 0.000 | 6116 95 4 |

Ready-for-connection Deskbox with connection cable, cable outlet at the bottom left of the profile with two fastening clamps for tabletop thicknesses of 8 to 40 mm.

Equipment:

- Five protective contact sockets in 0° connection direction, of which one socket is for continuous current and four sockets can be switched using a one-way switch (lit in blue), incl. 3.0 m power cable with angular connector CEE 7/7.
- Two data technology couplings RJ45 to RJ45, switched 1:1, Cat. 6 shielded.

| Type | Version | Pack. | Weight | Item No. |
|-----------------------|--------------------------|-------|-------------|------------------|
| | | pcs | kg/100 pcs. | |
| DB-0B3 D1.4S2K | Housing, silver anodised | 1 | 0.000 | 6116 95 7 |

Ready-for-connection Deskbox with connection cable, cable outlet at the bottom left of the profile, without fastening material, combinable with the fastening solutions listed in the accessories.

Equipment:

- Five protective contact sockets in 0° connection direction, of which one socket is for continuous current and four sockets can be switched using a one-way switch (lit in blue), incl. 3.0 m power cable with angular connector CEE 7/7.
- Two data technology couplings RJ45 to RJ45, switched 1:1, Cat. 6 shielded.

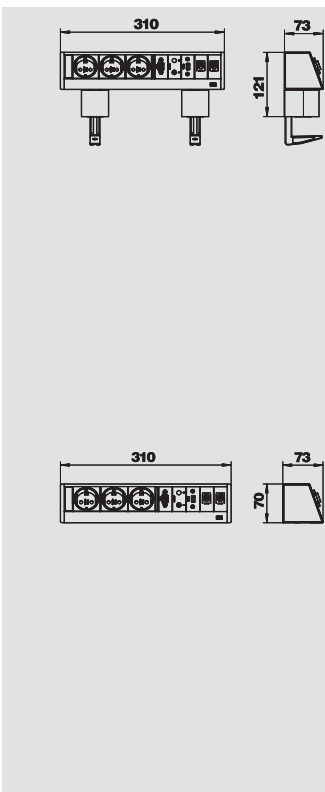

Deskbox with 3 sockets and data technology and multimedia connection

| Type | Version | Pack. | Weight | Item No. |
|----------------------|--------------------------|-------|-------------|------------------|
| | | pcs | kg/100 pcs. | |
| DB-M1B3 D3S2K | Housing, silver anodised | 1 | 0.000 | 6116 96 0 |

Ready-for-connection Deskbox with connection cable and cable outlet at the bottom left of the profile (power supply) and at the bottom right of the profile (multimedia) with two fastening clamps for tabletop thicknesses of 8 to 40 mm.

Equipment:

- Three protective contact sockets in 0° connection direction, incl. 3.0 m power cable with angular connector CEE 7/7.
- One VGA 15-pin HDD socket, incl. 3.0 m connection cable with connector.
- One audio jack socket 3.5 mm, incl. 3.0 m connection cable with connector.
- One USB 2.0, type A socket, incl. 3.0 m connection cable with type A connector.
- Two data technology couplings RJ45 to RJ45, 1:1 switched, Cat. 6 shielded.

| Type | Version | Pack. | Weight | Item No. |
|----------------------|--------------------------|-------|-------------|------------------|
| | | pcs | kg/100 pcs. | |
| DB-M0B3 D3S2K | Housing, silver anodised | 1 | 0.000 | 6116 96 3 |

Ready-for-connection Deskbox with connection cable and cable outlet at the bottom left of the profile (power supply) and at the bottom right of the profile (multimedia), without fastening material, combinable with the fastening solutions listed in the accessories.

Equipment:

- Three protection contact sockets in 0° connection direction, incl. 3.0 m power cable with angular connector CEE 7/7.
- One VGA 15-pin HDD socket, incl. 3.0 m connection cable with connector.
- One audio jack socket 3.5 mm, incl. 3.0 m connection cable with connector.
- One USB 2.0, type A socket, incl. 3.0 m connection cable with type A connector.
- Two data technology couplings RJ45 to RJ45, 1:1 switched, Cat. 6 shielded.



New Deskbox



Fastening clamp

| Type | Colour | Version | Pack. | Weight | Item No. |
|-----------------|--------|----------------------------|-------|-------------|------------------|
| | | | pcs | kg/100 pcs. | |
| DBZ-BZ40 | Black | Clamping range 8 to 40 mm | 1 | 0.000 | 6116 97 6 |
| DBZ-BZ75 | Black | Clamping range 40 to 75 mm | 1 | 0.000 | 6116 97 9 |

Fastening clamp for Deskbox mounting on the edge of a table.

Note: For housing widths of 200 mm or more, two fastening clamps are required to mount a Deskbox.

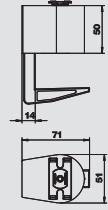

Stainless steel fastening stand

| Type | Pack. | Weight | Item No. |
|----------------|-------|-------------|------------------|
| | pcs | kg/100 pcs. | |
| DBZ-BFE | 1 | 0.000 | 6116 98 2 |

Stainless steel fastening stand for fixed Deskbox mounting on a tabletop. It is mounted using a drill hole (Ø16 mm) in the tabletop.

Note: Can be used in tabletops of up to 50 mm thickness.

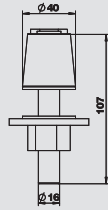

Fastening set for table mounting

| Type | Pack. | Weight | Item No. |
|----------------|-------|-------------|------------------|
| | pcs | kg/100 pcs. | |
| DBZ-BST | 1 | 0.000 | 6116 98 5 |

Fastening set for fixed Deskbox mounting on the tabletop. It is mounted using a drill hole (Ø10 mm) in the tabletop.

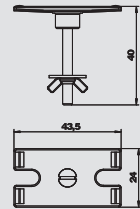

Flexkanal holder

| Type | Colour | Pack. | Weight | Item No. |
|-----------------|--------|-------|-------------|------------------|
| | | pcs | kg/100 pcs. | |
| DBZ-FLKB | Black | 1 | 0.000 | 6116 99 1 |

Flexkanal holder for secure connection of a Flexkanal to the Deskbox.

Note: Can only be used for mounting on the tabletop using fastening clamps.

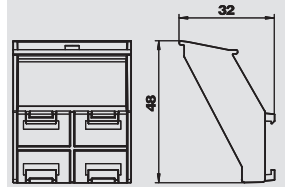

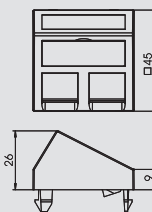
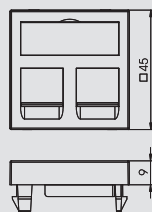

Data technology support, type A, 1/1 module width

| Type | Colour | Pack. | Weight | Item No. |
|---------------------|-----------------|-------|-------------|------------------|
| | | pcs | kg/100 pcs. | |
| DTG-2A RW1 | Pure white | 1 | 1.100 | 6119 20 2 |
| DTG-2A SWGR1 | Black-grey | 1 | 1.100 | 6119 20 4 |
| DTG-2A AL1 | Aluminium paint | 1 | 1.100 | 6119 20 6 |

Data technology support with straight outlet and locking slider to accept two data technology connection modules. The locking fastening is suitable for horizontal and vertical installation in the system environment.

Support plate, type A, to accept the following data connection modules: AMP TYCO: SL series 110Connect and Toolless, AMP-Twist (without dust protection cap); Brand-Rex: unshielded module; GG45; Nexans: LANmark with adapter clip.

Type A corresponds to a mounting opening in mm: 20.10 x 14.80.

| Type | Colour | Pack. | Weight | Item No. |
|---------------------|-----------------|-------|-------------|------------------|
| | | pcs | kg/100 pcs. | |
| DTS-2A RW1 | Pure white | 1 | 1.500 | 6119 23 8 |
| DTS-2A SWGR1 | Black-grey | 1 | 1.500 | 6119 24 0 |
| DTS-2A AL1 | Aluminium paint | 1 | 1.500 | 6119 24 2 |

Data technology support with slanting outlet and lock slide to accept two data technology connection modules. The locking fastening is suitable for horizontal and vertical installation in the system environment.

Support plate, type A, to accept the following data connection modules: AMP TYCO: SL series 110Connect and Toolless, AMP-Twist (without dust protection cap); Brand-Rex: unshielded module; GG45; Nexans: LANmark with adapter clip.

Type A corresponds to a mounting opening in mm: 20.10 x 14.80.

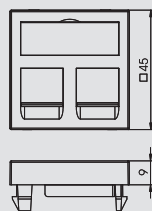

Data technology support, type B, 1/1 module width

| Type | Colour | Pack. | Weight | Item No. |
|---------------------|-----------------|-------|-------------|------------------|
| | | pcs | kg/100 pcs. | |
| DTG-2B RW1 | Pure white | 1 | 1.100 | 6119 20 8 |
| DTG-2B SWGR1 | Black-grey | 1 | 1.100 | 6119 21 0 |
| DTG-2B AL1 | Aluminium paint | 1 | 1.100 | 6119 21 2 |

Data technology support with straight outlet and locking slider to accept two data technology connection modules. The locking fastening is suitable for horizontal and vertical installation in the system environment.

Support plate, type B, to accept the following data connection modules: BTR: E-DAT; Dätwyler: MS and MS-N; Kerpen: VarioKeystone.

Type B corresponds to a mounting opening in mm: 19.35/21.55 x 14.85.

| Type | Colour | Pack. | Weight | Item No. |
|---------------------|-----------------|-------|-------------|------------------|
| | | pcs | kg/100 pcs. | |
| DTS-2B RW1 | Pure white | 1 | 1.500 | 6119 24 4 |
| DTS-2B SWGR1 | Black-grey | 1 | 1.500 | 6119 24 6 |
| DTS-2B AL1 | Aluminium paint | 1 | 1.500 | 6119 24 8 |

Data technology support with slanting outlet and lock slide to accept two data technology connection modules. The locking fastening is suitable for horizontal and vertical installation in the system environment.

Support plate, type B, to accept the following data connection modules: BTR: E-DAT; Dätwyler: MS and MS-N; Kerpen: VarioKeystone.

Type B corresponds to a mounting opening in mm: 19.35/21.55 x 14.85.

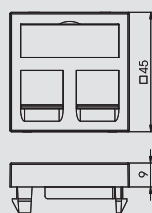
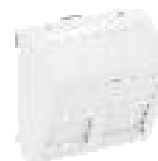

Data technology support, type C, 1/1 module width

| Type | Colour | Pack. | Weight | Item No. |
|---------------------|-----------------|-------|-------------|------------------|
| | | pcs | kg/100 pcs. | |
| DTG-2C RW1 | Pure white | 1 | 1.100 | 6119 21 4 |
| DTG-2C SWGR1 | Black-grey | 1 | 1.100 | 6119 21 6 |
| DTG-2C AL1 | Aluminium paint | 1 | 1.100 | 6119 21 8 |

Data technology support with straight outlet and locking slider to accept two data technology connection modules. The locking fastening is suitable for horizontal and vertical installation in the system environment.

Support plate, type C, to accept the following data connection modules: Brand-Rex: shielded module; Corning: modules with Keystone seat; Dätwyler: KS-T, MS-K and KU-T; EKU: E-Stone; R&M: Keystone; Rutenbeck: UM and UMflex; SETEC: UKJ and XKJ; Telegärtner: AMJ and UMJ.

Type C corresponds to a mounting opening in mm: 19.30 x 14.80.



Universal data technology support



Data technology support, type C, 1/1 module width

| Type | Colour | Pack. | Weight | Item No. |
|---------------------|-----------------|-------|-------------|------------------|
| | | pcs | kg/100 pcs. | |
| DTS-2C RW1 | Pure white | 1 | 1.500 | 6119 25 0 |
| DTS-2C SWGR1 | Black-grey | 1 | 1.500 | 6119 25 2 |
| DTS-2C AL1 | Aluminium paint | 1 | 1.500 | 6119 25 4 |

Data technology support with slanting outlet and lock slide to accept two data technology connection modules. The locking fastening is suitable for horizontal and vertical installation in the system environment.

Support plate, type C, to accept the following data connection modules: Brand-Rex: shielded module; Corning: modules with Keystone seat; Dätwyler: KS-T, MS-K and KU-T; ECU: E-Stone; R&M: Keystone; Rutenbeck: UM and UMflex; SETEC: UKJ and XKJ; Telegärtner: AMJ and UMJ. Type C corresponds to a mounting opening in mm: 19.30 x 14.80.

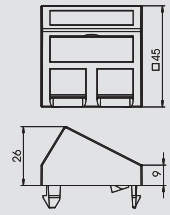

Data technology support, type EP, 1/1 module width

| Type | Colour | Pack. | Weight | Item No. |
|----------------------|-----------------|-------|-------------|------------------|
| | | pcs | kg/100 pcs. | |
| DTG-2EP RW1 | Pure white | 1 | 1.100 | 6119 23 2 |
| DTG-2EP SWGR1 | Black-grey | 1 | 1.100 | 6119 23 4 |
| DTG-2EP AL1 | Aluminium paint | 1 | 1.100 | 6119 23 6 |

Data technology support with straight outlet and locking slider to accept two data technology connection modules. The locking fastening is suitable for horizontal and vertical installation in the system environment.

Support plate, type EP, to accept the following data connection modules: Leoni Kerpen: ELine Premium-System.

Type EP corresponds to a mounting opening in mm: 16.0 x 14.0.

| Type | Colour | Pack. | Weight | Item No. |
|----------------------|-----------------|-------|-------------|------------------|
| | | pcs | kg/100 pcs. | |
| DTS-2EP RW1 | Pure white | 1 | 1.500 | 6119 26 8 |
| DTS-2EP SWGR1 | Black-grey | 1 | 1.500 | 6119 27 0 |
| DTS-2EP AL1 | Aluminium paint | 1 | 1.500 | 6119 27 2 |

Data technology support with slanting outlet and lock slide to accept two data technology connection modules. The locking fastening is suitable for horizontal and vertical installation in the system environment.

Support plate, type EP, to accept the following data connection modules: Leoni Kerpen: ELine Premium-System.

Type EP corresponds to a mounting opening in mm: 16.0 x 14.0.

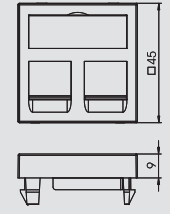

Data technology support, type F, 1/1 module width

| Type | Colour | Pack. | Weight | Item No. |
|---------------------|-----------------|-------|-------------|------------------|
| | | pcs | kg/100 pcs. | |
| DTG-2F RW1 | Pure white | 1 | 1.100 | 6119 22 0 |
| DTG-2F SWGR1 | Black-grey | 1 | 1.100 | 6119 22 2 |
| DTG-2F AL1 | Aluminium paint | 1 | 1.100 | 6119 22 4 |

Data technology support with straight outlet and locking slider to accept two data technology connection modules. The locking fastening is suitable for horizontal and vertical installation in the system environment.

Support plate, type F, to accept the following data connection modules: Avaya/Systemax: M series.

Type F corresponds to a mounting opening in mm: 17.40 x 16.60.

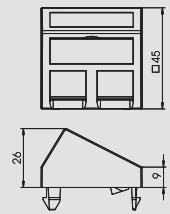

Data technology support, type PA, 1/1 module width

| Type | Colour | Pack. | Weight | Item No. |
|----------------------|-----------------|-------|-------------|------------------|
| | | pcs | kg/100 pcs. | |
| DTG-2PA RW1 | Pure white | 1 | 1.100 | 6119 22 6 |
| DTG-2PA SWGR1 | Black-grey | 1 | 1.100 | 6119 22 8 |
| DTG-2PA AL1 | Aluminium paint | 1 | 1.100 | 6119 23 0 |

Data technology support with straight outlet and locking slider to accept two data technology connection modules. The locking fastening is suitable for horizontal and vertical installation in the system environment.

Support plate, type PA, to accept the following data connection modules: Panduit: Mini-Com.

Type PA corresponds to a mounting opening in mm: 18.4 x 16.0.

