

LFS | Catalogue 2010/2011



Cable routing systems

THINK CONNECTED.

Welcome to Customer Service

Service telephone: +49 (0)2373 89-1500

Telefax for enquiries: +49 (0)2373 89-7777

Telefax for orders: +49 (0)2373 89-7755

E-mail: info@obo.de

Internet: www.obo.de



Use the direct line to OBO Customer Service! On the Service Hotline +49 (0)2373 89-1500, we are available every day from 7.30 a.m. to 5.00 p.m. for any questions about the OBO product range for electrical installations. The newly structured OBO Customer Service can offer you the full service:

- Competent contacts from your region
- All the information on the OBO product range
- Knowledgeable advice on special application topics
- Quick, direct access to all the technical data of the OBO and we also want to provide the best in customer relations

Contents

	Planning aid	5
	WDK cable trunking systems, plastic	83
	LKM metal cable trunking systems	137
	SKL skirting trunking systems	157
	VK wiring trunking systems, System Dahl	163
	Rapid 45 plastic device installation trunking systems	187
	Rapid 45 aluminium device installation trunking systems	199
	Rapid 80 GK plastic device installation trunking systems	207
	Rapid 80 GS sheet steel device installation trunking systems	219
	GEK-A aluminium device installation trunking	265
	Accessories for device installation trunking	303
	ISS service pole systems	315
	Device installation	337
	Directories	359



OBO LFS seminars: First-hand knowledge

With a comprehensive programme of training courses and seminars on the subject of cable routing systems, OBO is able to support its customers with specialist knowledge from a single source. Alongside the basic theoretical principles, the programme also deals with practical implementation in everyday applications. Special calculation and application examples round off the comprehensive programme of knowledge transfer.

Invitations to tender, product information and datasheets

We can make life easier for you. With our comprehensive selection of materials designed for practical applications, which provide you with effective support with the planning and calculation of a project. These include:

- Invitations to tender
- Product information
- Information sheets
- Datasheets

These documents are continually updated and can be downloaded at no charge at any time from the Internet download area at www.o-bo.de.











Invitations to tender on the Internet at

www.ausschreiben.de

More than 10,000 entries from the KTS, BSS, TBS, LFS, EGS and UFS ranges can be called up free of charge. Regular updates and expansions mean that you always have a comprehensive overview of the OBO products. All the current file formats (PDF, DOC, GAEB, HTML, TEXT, XML, ÖNORM) are available.

www.ausschreiben.de

Contents of planning and mounting aids

	General planning aid	6
	WDK cable trunking systems, plastic	13
	LKM metal cable trunking systems	19
	SKL skirting trunking systems	23
	VK wiring trunking system, System Dahl	27
	Rapid 45 device installation trunking, 45 mm system opening	35
	Rapid 80 device installation trunking, 80 mm system opening	41
	Accessories for device installation trunking	53
	Service pole systems	59
	Device installation	65
	Additional information	75



Inclusion of the cable routing systems and metal service poles in the service measures



Specifications for protective measures

If there is a fault, touchable metallic parts must not carry voltage. For this reason it is necessary to carry out appropriate safety measures. These are specified in the currently valid standards. EN 50085-1 and EN 50085-2-1 apply to the setup of the cable routing system, whilst the erection regulations DIN VDE 0100 Parts 410 and 540 apply to the installation (protection measure against dangerous shock currents).

Different installation types in the European standard

The European standard EN 50085-1 takes different installation types into account, as they are used in different countries within the EU. Whilst only equipotential bonding testing was previously required for installation trunking systems, now the listed component standards also require protective conductor functions. This is because, in some countries, it is possible to route insulated cable in trunking.

All the metallic components must be included

EN 50085-1 requires that all the metallic components must be included in the protective measures. The manufacturers must carry out the appropriate tests and document them. OBO installation trunking is also tested and certified by an external testing office – that of the VDE.

Testing the effectiveness by the installation engineers

The erector (installation engineer) must test the effectiveness of the protection measure in accordance with DIN VDE 0100 Part 610

after completion. Ensure the tightening torque of the contact screws on the earthing terminals and the proper mounting of the couplings.

Continuous protection measures

If the trunking is interrupted at a wall penetration, then continuation of the protective measures is required, as, in this case, the trunking is a foreign, conductive part, which spreads through different areas of a building.

With aluminium device installation trunking, the connection between the bases is created using the coupling. The connection between the covers and the device installation trunking is made using the self-contacting cover. This guarantees continuous protection without any additional wiring.

With the LKM metal cable trunking, a connection is made between the cover and the base without an additional earthing cable. The connection between the bases is made via the joint connector. Important: powder-coated metallic covers do not count as mixed construction and are thus not considered as insulating! They should therefore be included in the protective measure. The sheet-steel separating retainers are self-contacting. From the aspect of capacitive coupling and the possible static coupling, the inclusion of metallic device installation trunking covers is included in the planning of the protective conductor function. The shielding measure reduces electro-smog and generally achieves improved EMC protection. Protective conductor connections should be permanent. If there is a change to the system, e.g. for retro-installations, it is important to guarantee the maintenance of the protection functions.



Who needs to observe which standards

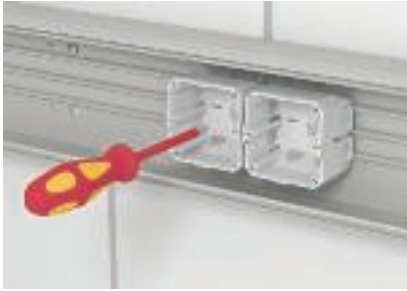

OBO as a manufacturer

Standard	Title	OBO system
DIN EN 50085-1 Device testing directive	Electrical installation systems for electrical installations, Part 1: General requirements	All systems
DIN EN 50085-2-1	Special requirements for electrical installation trunking systems on walls or ceilings.	WDK, LKM, SKL, GEK-K, GEK-S, GEK-A
prEN 50085-2-2	Special requirements for electrical installation systems for underfloor, flushfloor or on-floor installation.	UFS
DIN EN 50085-2-3	Special requirements for electrical installation trunking systems in distributor cabinets.	VK
prEN 50085-2-4	Special requirements for freestanding installation units.	ISS

The installation engineer as systems engineer

Standard	Title	OBO system
VDE 0100 Part 410	Setup of electrical systems with rated voltages of up to 1,000 V. Protection against electric shock.	All systems
VDE 0100 Part 520	Setup of electrical systems with rated voltages of up to 1,000 V. Cables.	All systems
VDE 0100 Part 540	Setup of electrical systems with rated voltages of up to 1,000 V. Equipotential bonding.	All systems
VDE 0100 Part 610	Setup of electrical systems with rated voltages of up to 1,000 V. First testing of electrical systems before handover to the operator.	All systems
VDE 0298	Setup of electrical systems with rated voltages of up to 1,000 V. Insulated cables in heavy current systems.	All systems
DIN EN 50310	Application of equipotential bonding and earthing in buildings with information technology equipment.	All systems



How can I work out the cable volume

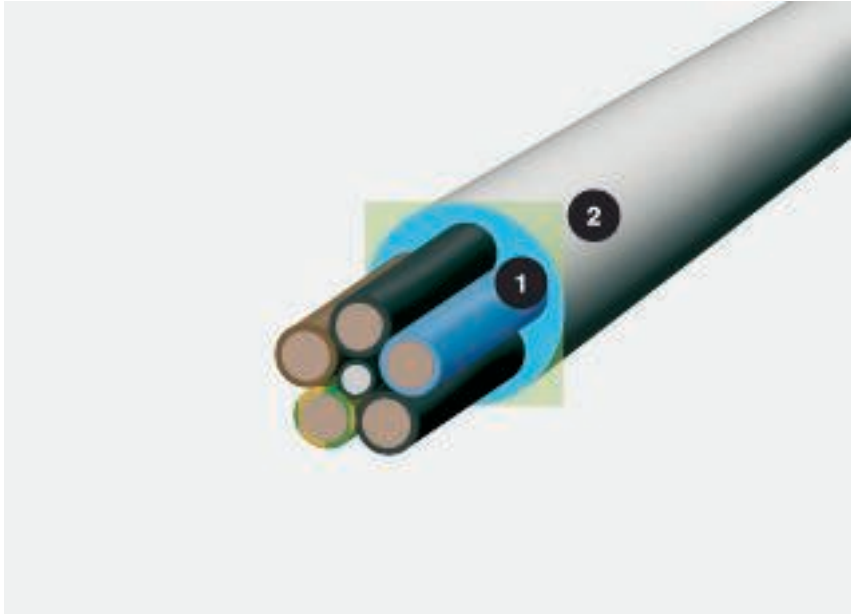

Cable diameter and space required; 1 = diameter in mm, 2 = space required in cm²

An important criterion for the selection of the right trunking size of the underfloor system is the cable volume. As the cables are never packed tightly together or are absolutely parallel, it is not enough to base the volume calculation solely on the cable diameter. A realistic calculation is provided by the formula $(2r)^2$. To simplify your work, we have listed the diameters and space requirements of the most important cable types on this double page. Important: the values are average values, which may vary between manufacturers. Please refer to the manufacturer's specifications for the exact values.

The right choice

The table on this page will help you to select the correct trunking size. Besides the usable cross-section of the appropriate trunking, please observe the current DIN/VDE standards for the fill factor and the approved cable heating.

Calculation using the formula $(2r)^2$

The diameter says little about the actual space required by a cable. Calculate: $(2r)^2$. This value reflects the realistic space requirements, including the compartments.



General planning aids, cable volume table



Insulated power cables

Type	Diameter mm	Useful cross-section cm ²
1 x 4	6.5	0.42
1 x 6	7	0.49
1 x 10	8	0.64
1 x 16	9.5	0.9
1 x 25	12.5	1.56
3 x 1.5	8.5	0.72
3 x 2.5	9.5	0.9
3 x 4	11	1.21
4 x 1.5	9	0.81
4 x 2.5	10.5	1.1
4 x 4	12.5	1.56
4 x 6	13.5	1.82
4 x 10	16.5	2.72
4 x 16	19	3.61
4 x 25	23.5	5.52
4 x 35	26	6.76
5 x 1.5	9.5	0.9
5 x 2.5	11	1.21
5 x 4	13.5	1.82
5 x 6	14.5	2.1
5 x 10	18	3.24
5 x 16	21.5	4.62
5 x 25	26	6.76
7 x 1.5	10.5	1.1
7 x 2.5	13	1.69



Insulated power cables

Type	Diameter mm	Useful cross-section cm ²
1 x 10	10.5	1.1
1 x 16	11.5	1.32
1 x 25	12.5	1.56
1 x 35	13.5	1.82
1 x 50	15.5	2.4
1 x 70	16.5	2.72
1 x 95	18.5	3.42
1 x 120	20.5	4.2
1 x 150	22.5	5.06
1 x 185	25	6.25
1 x 240	28	7.84
1 x 300	30	9
3 x 1.5	11.5	1.32
3 x 2.5	12.5	1.56
3 x 10	17.5	3.06
3 x 16	19.5	3.8
3 x 50	26	6.76
3 x 70	30	9
3 x 120	36	12.96
4 x 1.5	12.5	1.56
4 x 2.5	13.5	1.82
4 x 6	16.5	2.72
4 x 10	18.5	3.42
4 x 16	21.5	4.62
4 x 25	25.5	6.5
4 x 35	28	7.84
4 x 50	30	9
4 x 70	34	11.56
4 x 95	39	15.21
4 x 120	42	17.64
4 x 150	47	22
4 x 185	52	27
4 x 240	58	33.6
5 x 1.5	13.5	1.82
5 x 2.5	14.5	2.1
5 x 6	18.5	3.42
5 x 10	20.5	4.2
5 x 16	22.5	5.06
5 x 25	27.5	7.56
5 x 35	34	11.56
5 x 50	40	16



Telecommunications cables

Type	Diameter mm	Useful cross-section cm ²
2 x 2 x 0.6	5	0.25
4 x 2 x 0.6	5.5	0.3
6 x 2 x 0.6	6.5	0.42
10 x 2 x 0.6	7.5	0.56
20 x 2 x 0.6	9	0.81
40 x 2 x 0.6	11	1.12
60 x 2 x 0.6	13	1.69
100 x 2 x 0.6	17	2.89
200 x 2 x 0.6	23	5.29
2 x 2 x 0.8	6	0.36
4 x 2 x 0.8	7	0.49
6 x 2 x 0.8	8.5	0.72
10 x 2 x 0.8	9.5	0.9
20 x 2 x 0.8	13	1.69
40 x 2 x 0.8	16.5	2.72
60 x 2 x 0.8	20	4
100 x 2 x 0.8	25.5	6.5
200 x 2 x 0.8	32	10.24



IT cables Type Cat...

Type	Diameter mm	Useful cross-section cm ²
Cat. 5	8	0.64
Cat. 6	8	0.64



Coax cable (Standard)

Type	Diameter mm	Useful cross-section cm ²
SAT/BK cable	6.8	0.48



Processing materials with the correct tool

Different materials must be processed differently. Chop saws have proved to be very useful when laying device installation trunking. This allows exact cutting.

Trunking made of PVC and PC/ABS:

- Hand saw, fine-tooth (iron saw)
- Piercing saw with iron or plastic saw blade with fine teeth
- Circular saw with plastic saw blade, 350 mm diameter, 80–108 teeth/inch and 2,800 rpm

Sheet steel and aluminium trunking:

- Ribbon saw with saw ribbon for hard metals
- Circular saw with saw blade for hard metals, 350 mm diameter, 80–108 teeth/inch and 2,800 rpm
- Angle grinder with metal separating disc

Take the length expansion of the materials into account

Different materials expand differently and this must be taken into account. The expansion of the materials PVC, steel and aluminium can be calculated using the formula below.

$$\Delta L = L \cdot \alpha \cdot \Delta T$$

L = Length m

α = Thermal expansion co-efficient

ΔT = Temperature change

Thermal expansion coefficient:

Properties of the hard PVC used

Property	Value	DIN
Material designation	PVC-U-E-D-08-04-28	to DIN 7748
Tensile strength	min. 40 N/mm ²	to DIN 53 455
Crack expansion	min. 85%	to DIN 53 455
Breakdown voltage	min. 20 KV/mm	to DIN 53 481
Surface resistance	min. 1,010 Ohm	to DIN 53 455
Shape heat resistance	min. 75 °C	to DIN 53 400/B
Temperature resistance in the application	max. 65 °C	
Flammability	Level V0	to UL 94
Glow wire test	960 °C	to DIN IEC 695

You can find more details in the chapter "Chemical resistance of hard PVC" in the "Additional information" part.

- Steel: $14 \times 10^{-6}/1 \text{ K}$
- Aluminium: $23.1 \times 10^{-6}/1 \text{ K}$
- Hard PVC: $71 \times 10^{-6}/1 \text{ K}$

Examples

At a temperature difference ΔT of 20°, the 2,000 mm standard length changes as follows:

- For hard PVC, 2.84 mm
- For steel, 0.56 mm
- For aluminium, 0.924 mm

Perfect interplay for more efficient working

Faster and better installation sequences – this is the aim of both ourselves and the manufacturers of electrical devices. Previously used bolt-firing devices have thus become modern nail guns. With its Pulsa 700E, Spit can offer devices of the highest quality for this area of the electrical industry. Many OBO products can be processed particularly efficiently using the devices. This is proved by tests for mounting cable and device installation trunking, carried out with Spit devices.



Colours



RAL, NCS, DB

The wide range of standard colours and the many possible special colours mean that it is possible to integrate the colour of the cable routing systems into any office landscape. The plastic cable trunking and device installation trunking systems are available in the RAL colours pure white (RAL 9010), light grey (RAL 7035), grey (RAL 7030) and cream (RAL 9001) as standard. The device installation trunking systems and service poles are made of sheet steel or aluminium and are available in the standard colours pure white, light grey and cream. Powder coating means that all the other RAL colours are possible on sheet-steel and aluminium trunking. Alternatively to the RAL standard, both NCS and DB colours can be applied on request.





Accessories Rapid 80 device installation trunking



Installation principle of panel and convection grid systems	54
Mounting aid, device installation trunking accessories	55



Installation principle of panel and convection grid systems

System components

1	Device installation trunking, steel
2	Steel cover
3	Plastic cover
4	Partition
5	Convection grid profile
6	Profile connector, horizontal
7	Profile connector, vertical
8	Mounting and connection profile
9	Floor panel
10	Convactor panelling

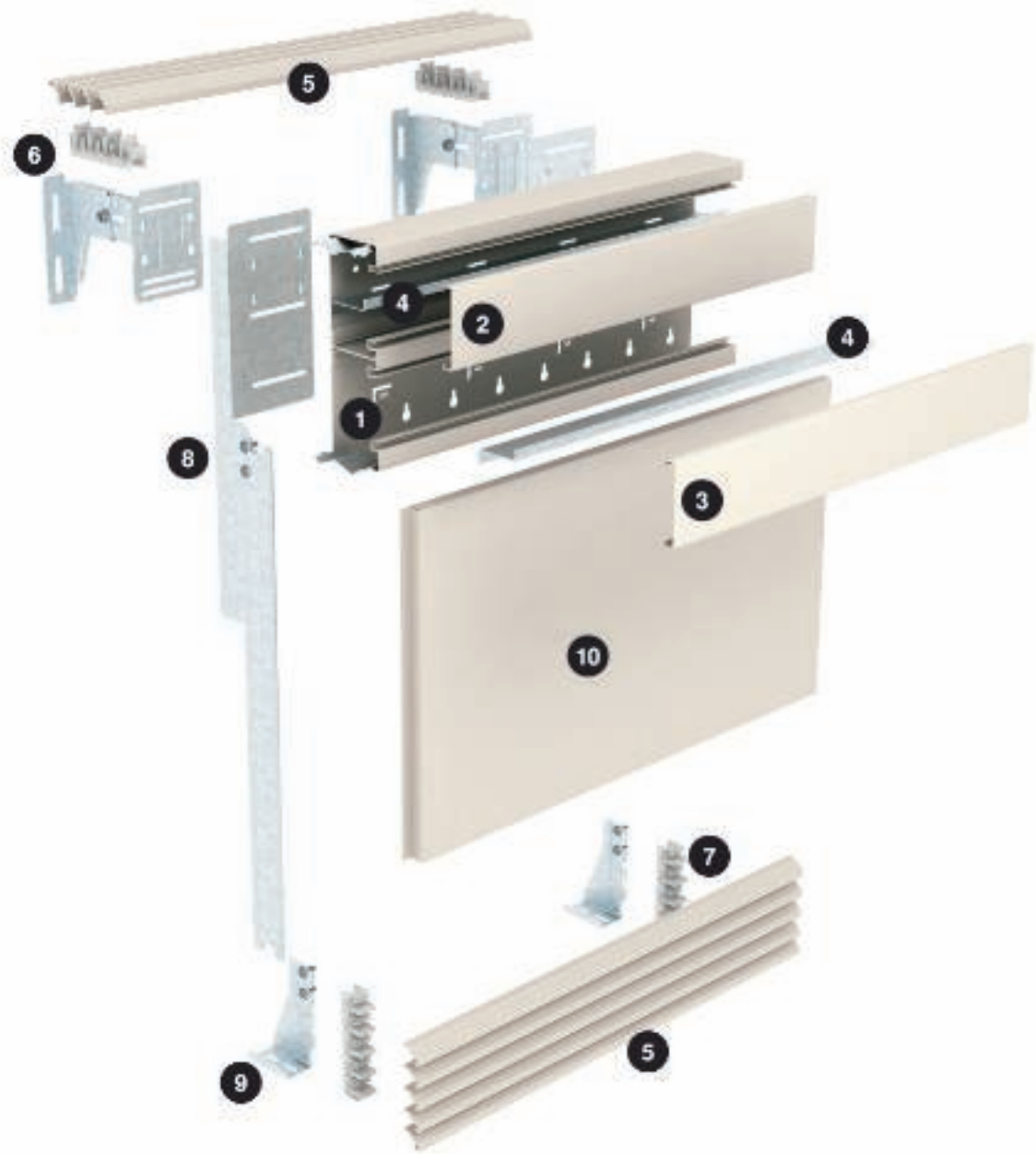

Mounting aid, accessories Rapid 80 device installation trunking



Convactor panelling, open at bottom

Often, convector panelling is planned in such a way that it is not connected to the floor, in order to aid room cleaning.



Convactor panelling, closed at bottom

To ensure the continued circulation of the room air, the connection to the floor should be made with convection grids.



Panelling with convection grids

Convactor panelling can also be fully created using convection grids. The spaces between the lamellae supports circulation and creates a visually attractive solution.



Installation of wall bracket

The fastening holes for wall brackets are drawn on the wall using a chalk mark. The maximum panel spacing should be 600 mm.



Installation of wall bracket

The holes for fastening the wall brackets are drilled and the wall panels fastened to the walls using bolts and anchors.



Installation of wall bracket

The height and depth of the wall panels are aligned one after the other and then the panels are locked.



Installation of stabilising profile

The stabilisation profile is required to install GEK device installation trunking of trunking height 213 mm. This is simply locked into the front of the existing panels.



Installation of connection profile

When combined with the vertically aligned convection grids or convactor panelling, the appropriate installation and connection profiles are locked to the front of the fixing panels.



Installation of connection profile

The mounting and connection profiles, type 6VG3/.., are required to install convection grid profiles, type 6VV3/.. are required for closed convactor panelling.



Installation of device installation trunking on wall bracket

The GEK device installation trunking is mounted on the wall racket and fastened using the M5 fastening screws. This also creates a conductive connection between the trunking and the wall bracket.



Installation of profile connector

The profile connectors for horizontal convection grids are attached to the wall brackets and locked with the clamp.



Installation of spacings for convection grid mounting

When mounting convection grids on the wall panels, ensure that a maximum spacing of 150 mm is maintained between the end of the grid lamella and the wall panels.



Mounting aid, accessories Rapid 80 device installation trunking

Planning aid, device installation trunking accessories



Installation of convection grids

The convector grid lamellae are inserted and locked in the profile connector one after another.



Installation of convection grids

The profile connectors are available in different lengths for accepting between two and twelve convection grid lamellae. If necessary, they can be mounted one behind the other on the fastening panels.



Convection grid with device installation trunking

The horizontal convection grids present a high-quality appearance and a perfect transition between the device installation trunking and the wall. They also allow the room air to circulate.



Installation of convector panelling

To mount the convector panelling, first attach the mounting and connection profiles 6VV3/... During planning, specify the length of the mounting blades according to the size of the convector panelling.



Installation of convector panelling

The convector panelling is attached to the mounting and connection profile and clamped at the bottom using the mounting blade. Fastening on the floor is only required in conjunction with the installing of the floor panel BVB125 for the acceptance of additional convector grid lamellae.



Installation of convector panelling

If panelling is required down to the floor, mount the floor bracket first. Then the selected profile connector can be locked in place.



Installation of convector panelling

After installing the floor panels, the convector panelling can be installed first, followed by the convection grid lamellae.



Mounting of vertical convection grids

The convection grid profiles are also simply locked into the profile connectors for vertical mounting.



Fire protection systems

OBO KBK-K fire protection cushions are the ideal solution for running PVC device installation trunking or cable ducts through walls classified as fire resistance.



Fire protection systems

The OBO FBA-BK fire protection blocks made of permanently elastic foam are superbly suited as insulation for metal or plastic trunking.

Mounting aid, accessories Rapid 80 device installation trunking



Soundproofing barrier

The noise limit barrier is fitted in the trunking in the area of a wall penetration between two rooms. These achieve noise insulation of approx. 40 dB.



Mounting of wall cover

The wall cover is mounted on the already mounted device installation trunking. For this, pull off the double-sided adhesive tape on the bottom side and stick it on the wall cover.



Supply trunking

With its tightly closable cover, the supply trunking is ideal for feeding in cables in device installation trunking.



Installation complete

The well-thought-out and matched components allow the creation of high-quality, tidy installations.



Plastic materials

GUM — Rubber

HP — Hard cardboard

MGUM — Foam rubber

PA — Polyamide

Temperature resistance:
permanently up to approx. 90 °C, briefly up to about 130 °C
and to about minus 40 °C*.

Chem. resistance generally as for polyethylene.

Resistant to

Petrol, benzene, diesel oil, acetone, solvents for paints and lacquers, oils and greases.

Bleach, most acids, chlorine.

Low in air-humid conditions; only with some aqueous salt solutions.
Highly desiccated parts (high temperature and extremely low air humidity) are highly sensitive to fuels and various solvents.

PA/GF — Polyamide, fibreglass reinforced

Temperature resistance:
permanently up to 100–110 °C, briefly up to 160 °C
and to about minus 40 °C*.

Resistant to

Petrol, benzene, diesel oil, acetone, solvents for paints and lacquers, oils and greases.

Slightly susceptible to stress-cracking.

Bleach, most acids, chlorine.

Low in air-humid conditions; only with some aqueous salt solutions.
Highly desiccated parts (high temperature and extremely low air humidity) are highly sensitive to fuels and various solvents.

PE — Polyethylene

Temperature resistance:
hard types permanently up to about 90 °C, briefly up to about 105 °C,
soft types permanently up to about 80 °C, briefly up to about 100 °C and
to about minus 40 °C*.

Resistant to

Alkalis and inorganic acids.

Conditionally resistant to

Acetone, organic acids, petrol, benzene, diesel oil, most oils.

Chlorine, hydrocarbons, oxidising acids.

Relatively high.

Stress cracks can be caused by, among others, acetone, various alcohols, formic acid, ethanol, petrol, benzene, butyric acid, acetic acid, formaldehyde, various oils, petroleum, propanol, nitric acid, hydrochloric acid, sulphuric acid, soap solutions, turpentine, trichloroethylene, citric acid.

PP — Polypropylene

Temperature resistance:
permanently up to approx. 90 °C, briefly up to about 110 °C
and to about minus 30 °C*.

Chem. resistance generally as for polyethylene.

Resistant to

Alkalis and inorganic acids.

Conditionally resistant to

Acetone, organic acids, petrol, benzene, diesel oil, most oils

Chlorine, hydrocarbons, oxidising acids.

Low, only with some acids such as chromic acid, hydrofluoric acid and hydrochloric acid, as well as nitrogen oxide.

PVC — Polyvinylchloride

Temperature resistance:
permanently up to 65 °C, briefly up to 75 °C and to about minus 30 °C.

Resistant to

Weak acids, alkalis, oils and greases, petrol.

Strong acids, benzene, acetone, iodine, toluene, trichloroethylene.

Low, only with some solvents such as benzene and acetone.

*The minus values apply only for parts in the quiescent condition with no severe impact stress.

There is no plastic that is resistant to every chemical. The agents listed are only a small selection. Plastic parts are especially at risk in the presence of chemicals and high temperatures. Stress cracks may occur. If in doubt, please consult us and/or ask for a detailed chemical resistance table.

Stress crack formation: stress cracks may occur if plastic parts under tension are exposed to chemicals at the same time. Parts made of polystyrene and polyethylene are particularly susceptible. Stress cracks may even be caused by agents to which the plastic in question is resistant in the absence of stress. Typical examples of parts under constant stress when used as intended: grip clips, intermediate supports of cable glands, ribbon clips.



European classification

Classification to EN 50085-1

		WDK Cable trunking	LKM Cable trunking	SKL Skirting trunking	VK Wiring trunking	GEK-K Device installation trunking Rapid 45	GEK-A Device installation trunking Rapid 45	GK Device installation trunking	GS Device installation trunking	GEK-A Device installation trunking	ISS Service pole
6.1	According to material	*2	*2	*2	*2	*2	*2	*2	*2	*2	*2
6.2	According to impact resistance for installation and application		*1								
6.2.1	Electrical installation duct systems for impact energy 0,5 J.	x	*1								
6.2.2	Electrical installation duct systems for impact energy 1 J.		*1								
6.2.3	Electrical installation duct systems for impact energy 2 J.		*1								
6.2.4	Electrical installation duct systems for impact energy 5 J.		*1			x		x			
6.2.5	Electrical installation duct systems for impact energy 20 J.		*1				x		x	x	x
6.3	According to temperature, as specified in the Tables 1, 2 and 3										
	Table 1: Minimum storage and transport temperatures $\pm 2\text{ }^{\circ}\text{C}$										
	-45										
	-25		x				x		x	x	x
	-15		x			x		x			
	-5	x	x		x						
	Table 2: Minimum installation and application temperatures $\pm 2\text{ }^{\circ}\text{C}$										
	-25		x				x		x	x	x
	-15					x		x			
	-5	x									
	+5										
	+15				x						
	Table 3: Maximum application temperatures $\pm 2\text{ }^{\circ}\text{C}$										
	+60	x			x	x	x	x	x	x	x
	+90										
	+105										
	+120										
6.4	According to the resistance against fire spread										
6.4.1	Electrical installation trunking systems which allow the spread of fire	x			x	x		x			
6.4.2	Electrical installation trunking systems which do not permit the spread of fire		x	x			x		x	x	x

x Appropriate classification, *1 in test, *2 under consultation



European classification

Classification to EN 50085-1

		WDK Cable trunking	LKM Cable trunking	SKL Skirting trunking	VK Wiring trunking	GEK-K Device installation trunking Rapid 45	GEK-A Device installation trunking Rapid 45	GK Device installation trunking	GS Device installation trunking	GEK-A Device installation trunking	ISS Service pole
6.5	According to the electrical conductivity										
6.5.1	Electrical installation trunking system with electrical conductivity		x				x		x	x	x
6.5.2	Electrical installation trunking system without electrical conductivity	x		x	x	x		x			
6.6	According to the electrical insulation property										
6.6.1	Electrical installation trunking system without electrical insulation property	x		x	x	x		x			
6.6.2	Electrical installation trunking system with electrical insulation property		x				x		x	x	x
6.7	According to the protection ratings offered by the housing or casing to EN 60529:1991										
6.7.1	According to protection against ingress of solid foreign bodies	x	IP30	x			x	x	x	IP30	IP30
6.7.2	According to protection against ingress of water										
6.7.3	According to protection against contact with dangerous parts										
6.8	According to protection against corrosive or impure substances	*2									
6.9	According to the fastening type of the system trunking cover										
6.9.1	Only open the trunking cover of the electrical installation trunking system without tools	x	x		x						
6.9.2	Only open the trunking cover of the electrical installation trunking system with tools					x	x	x	x	x	
6.10	According to the electrical protection separation										
6.10.1	Electrical installation trunking systems without internal protection separation element		x		x		x		x	x	
6.10.2	Electrical installation trunking systems with internal protection separation element	x				x		x			

x Appropriate classification, *2 under consultation



European classification

Classification to EN 50085-2-1

		WDK Cable trunking	LKM Cable trunking	SKL Skirting trunking	VK Wiring trunking	GEK-K Device installation trunking Rapid 45	GEK-A Device installation trunking Rapid 45	GK Device installation trunking	GS Device installation trunking	GEK-A Device installation trunking	ISS Service pole
6.101.3	Concealed/surface-mounded electrical installation trunking on the wall or ceiling.										
6.101.3.1	Concealed/surface-mounded electrical installation trunking on the wall.	x	x			x	x	x	x	x	
6.101.3.2	Concealed/surface-mounded electrical installation trunking on the ceiling.	x	x			x	x	x	x	x	
6.101.3.3	Electrical installation trunking on the wall and supported by the base.										
6.101.3.4	Electrical installation trunking on the wall and supported by a different horizontal surface to the floor.										
6.101.4	Electrical installation trunking system, mounted at a distance to the wall or ceiling with fastenings.					x	x	x	x	x	
6.102	According to the protection against contact between liquids and insulated cables and parts carrying voltage in the case of skirting trunking and wet cleaning of the floor.										
6.102.1	No data										
6.102.2	Add to the instructions of the manufacturer, which limit the installation position of the electrical installation trunking system.					x	x				
6.102.3	Add to the instructions of the manufacturer, which allow all the installations of the electrical installation trunking system, but limits the layers of insulated cables and parts carrying voltage in the electrical installation trunking system.										
6.102.4	Add to the instructions of the manufacturer, which allow all the installations of the electrical installation trunking system and allows the layers of insulated cables and parts carrying voltage in the electrical installation trunking system.										
6.103	According to type										
6.103.1	Type 1 Electrical installation trunking system										
6.103.2	Type 2 Electrical installation trunking system (distribution electrical installation trunking system)	x	x								
6.103.3	Type 3 Electrical installation trunking system (installation electrical installation trunking system)				x	x	x	x	x	x	

x Appropriate classification



Chemical resistances of hard PVC

A = very good resistance
B = average resistance
C = not resistant

Medium	Temp. °C	Resistance
1.3-benzole disulphonic acid	20	A
1.3-butadiene	20	A
2.4-chlorobenzoyl chloride	20	A
2-amino-2.2-diphenylacetic acid	20	A
4-chlorine-2-nitroaniline	20	C
4-chlorobenzaldehyde-2-sulphonic acid	20	A
5-amino-2-hydroxybenzoic acid	20	A
Abietic acid	20	A
Acetaldehyde 100%	20	C
Acetaldehyde 40%	20	A
Acetaldehyde 40%	40	B
Acetaldehyde, acetic acid ratio 90:10	20	B
Acetanilide 100%	20	A
Acetates (ammonium-, Na- and others)	50	A
Acetic acid 10%	60	A
Acetic acid 100%	20	A
Acetic acid 100%	60	B
Acetic acid 25%	40	A
Acetic acid 25-70%	40	A
Acetic anhydride	20	C
Acetone	20	C
Acetophenone (methyl phenyl ketone)	20	C
Acetylacetone (2.4-pentanedione)	20	C
Acetylene 100%	20	B
Acetylsalicylic acid	20	A
Adipic acid	20	A
Adipic acid	60	B
Alcoholic drinks	< 40	A
Alizarin 100%	20	A
Alkanoic sulphonic acids	50	A
Allyl alcohol 100%	20	B
Allyl alcohol 100%	60	C
Allyl chloride	20	C
Aminobenzene (p-)	20	A
Aminobenzenesulphonic acid (m-, o-, p-)	20	A
Aminosalicic acid (p-)	20	A
Ammonia (vapours of all concentrations)	40	A
Ammonia (vapours of all concentrations)	60	B
Ammonia, anhydrous, liquid	< 60	B
Ammonium hydroxide	60	A
Aniline 100%	20	A
Aniline chloride, saturated solution	20	C
Apple juice	60	A
Ascorbic acid	20	A
Aspartic acid	20	A
Beer	60	A
Benzine, containing benzole	20	C
Benzine, free from aromatic hydrocarbons	60	A
Benzoic acid	40	A
Benzoic anhydride	30	A
Benzole	20	C
Benzophenone 100%	20	C
Benzosulphonic acid	60	A
Benzotrithloride	20	C
Benzotrifluoride	20	C
Benzoylbenzoic acid	20	A
Benzyl chloride	20	C
Betene	20	A
Bleaching liquor, 12% active chlorine	40	A
Bleaching liquor, 12% active chlorine	60	B
Blood	40	A
Boiled oil	60	C
Borates (NA-)	20	A
Borax	40	A
Boric acid	20	A
Brewer's wort	20	A
Brine	60	A
Bromates (K-, Na-)	40	A
Bromic acid	20	A
Bromides (K-, Na- and others)	60	A
Bromine water	20	A
Bromine, gaseous, dry	20	A
Bromine, liquid	20	C
Bromobenzene	20	C
Bromochloromethane	20	C
Bromochloropropane	20	C
Bromoform 100%	20	C
Butane, gaseous, 30%	20	A
Butanediol over 60%	40	B
Butanediol over 60%	20	C
Butanediol to 10%	20	A
Butanol	60	A
Buttermilk	20	A
Butyl acetate	20	C
Butyl butyrate	20	C
Butyl chloride	20	C

A = very good resistance
B = average resistance
C = not resistant

Medium	Temp. °C	Resistance
Butyl glycolate	20	C
Butyl phenoles	20	C
Butyric acid 100%	20	C
Butyric acid 20%	20	A
Butyric acid 20%	60	C
Carbon dioxide	60	A
Carbon disulphide 100%	20	B
Carbon monoxide	60	A
Castor oil	60	A
Chlorates (K-, Na- and others)	20	A
Chlorates (K-, Na- and others)	60	B
Chlorates (K-, Na- and others)	60	A
Chloric acid to 20%	40	A
Chloric acid to 20%	60	B
Chlorides (ammonium-, Na- and others)	20	A
Chlorine cyanide	20	A
Chlorine water (saturated solution)	20	B
Chlorine, gaseous, dry 0.5%	20	A
Chlorine, gaseous, dry 100%	20	B
Chlorine, gaseous, moist 5%	20	B
Chlorine, liquid	20	C
Chloroacetaldehyde	20	C
Chloroacetic acid	20	A
Chloroacetones	20	C
Chloroacetylchloride	20	C
Chloroanilines	20	C
Chlorobenzaldehyde	20	C
Chlorobenzene	20	C
Chlorobenzotrifluoride	20	C
Chlorobenzoylchloride	20	C
Chlorocresoles	20	C
Chloroethylbenzene	20	C
Chloroform	20	C
Chloronaphthalines	20	C
Chloronitrobenzoic acid	20	A
Chromates (K-, Na- to 50%)	50	A
Chrome alum	60	A
Chromic acid	30	A
Chromic acid to 50%	40	A
Citrates (ammonium-, Na)	20	A
Citric acid	20	A
Citric acid	60	B
Cresol	20	C
Cumene	20	C
Cyanacetic acid	20	C
Cyanamide	20	A
Cyanides (K-, Na- to 50%)	60	A
Cyclohexanol	20	C
Cyclohexanone	20	C
Developer	40	A
Dextrose	50	A
Dibromomethylene	20	C
Dibutyl phthalate	20	C
Dibutylxalate	20	C
Dichloroethylene	20	C
Dichloropropylene	20	C
Dichromates (K-, Na-)	50	C
Diethyl ether	20	C
Diethylamine 100%	20	C
Diethylene glycol	60	C
Dimethylether	20	C
Di-n-butylether	20	C
Diotylphthalate	20	C
Dioxan	20	C
Diphenyl	20	C
Diphenylamine	20	C
Ethane	20	A
Ethanol	40	A
Ethanolamine	20	B
Ethyl acetate	20	C
Ethyl acrylate	20	C
Ethyl chloride	20	C
Ethylbenzene	20	C
Ethylene glycol	20	A
Fish oil	20	A
Fixing bath	60	A
Fluorides (ammonium-, K-, Na- and others)	60	A
Fluorine	20	B
Fluorine	60	C
Formaldehyde	60	A
Formamide 100%	20	C
Formiates (ammonium- and others)	20	A
Formic acid 100%	20	B
Formic acid 100%	60	C
Formic acid 50%	40	A
Furfural	20	C



Chemical resistances of hard PVC

A = very good resistance
B = average resistance
C = not resistant

Medium	Temp. °C	Resistance
Furfuryl alcohol	20	C
Gelatine	60	A
Gluconic acid	20	A
Glucose	60	A
Glutamic acid	20	A
Glycerine	60	A
Glycine	40	A
Glycol	60	A
Heptanes	20	A
Hexachloroethane	20	C
Hexacyanoferrates-II (Na-)	40	A
Hexacyanoferrates-III (K-)	40	A
Hexafluorosilicates (ammonium-, K- and others)	60	A
Hexafluorosilicic acid 32%	60	A
Hexamethylenetetramine (urotropine) 40% aqueous solution	60	A
Humic acids	20	A
Hydrazine, diluted solution 100%	20	C
Hydrazine, diluted solution 30%	20	A
Hydrobromic acid to 40%	60	A
Hydrochloric acid to 30%	20	A
Hydrochloric acid to 30%	60	B
Hydrochloric acid to 37%	20	A
Hydrochloric acid to 37%	40	B
Hydrofluoric acid to 40%	40	A
Hydrofluoric acid to 40%	60	B
Hydrogen bromide 100%	20	A
Hydrogen bromide 100%	60	B
Hydrogen chloride (gaseous, dry and moist)	40	A
Hydrogen cyanide	40	A
Hydrogen peroxide to 30%	60	A
Hydrogen peroxide to 90%	20	A
Hydrogen sulphide	60	A
Hydroxides (alkaline-earth metal)	60	A
Hydroxides (K-, Na-)	60	A
Hypochlorites (K-, Na- and others)	60	A
hypochlorous acid	60	A
Illuminating gas	20	A
Iodates (K-, Na- and others)	60	A
Iodides (K-, Na-)	60	A
Iodine	20	C
Isobutylphosphate	20	C
Lactic acid 10%	20	A
Lactic acid 10%	60	C
Lactic acid 100%	20	C
Lard	20	A
Linoleic acid	60	A
Linseed oil	60	A
Malic acid	20	A
Material characteristics		
Methanol 100%	40	A
Methanol 100%	60	B
Methyl bromide	20	C
Methyl chloride	20	C
Methyl methacrylate	20	C
Methylamine	20	B
Methylene dichloride	20	C
Milk	20	A
Mineral oils	60	C
N,N-diethyl aniline	20	C
Naphthalene	20	C
Nitrates (ammonium-, K-, Na- and others)	60	A
Nitric acid 25%	20	A
Nitric acid 25%	60	B
Nitric acid 50%	20	A
Nitric acid 50%	50	B
Nitric acid 95%	20	C
Nitrites (K-, Na- and others)	60	A
Nitrobenzene	20	C
Nitrogen oxide	20	C
Nitroglycerine	20	B
Nitrous acid to 50%	50	A
Nitrous acid to 98%	20	C
Oleic acid	60	A
Oxalates (ammonium-, K-, Na- and others)	60	A
Oxalic acid	40	A
Oxygen	60	A
Ozone 10%	30	A
Ozone 10%	60	B
Palmitic acid	20	A
Paraffin	40	A
Pentyl laurate	20	C
Pentylacetate	20	C

A = very good resistance
B = average resistance
C = not resistant

Medium	Temp. °C	Resistance
Pentylalcohol	60	A
Pentylchloride	20	C
Perbonate (K-)	60	A
Perchlorate	40	A
Perchloric acid 70%	20	A
Permanganate (K-) 6 to 15%	40	A
Permanganate (K-) 6 to 15%	60	B
Permanganate (K-) to 6%	60	A
Peroxymonosulphuric acid (Caro's acid)	20	A
Persulphate (Ammonium-, K-, Na- and others)	40	A
Petroleum	60	A
Phenol 1%	20	A
Phenol 90%	45	B
Phenylhydrazine	20	C
Phenylhydrazine chloride	20	B
Phenylhydrazine chloride	60	C
Phosgene, gaseous	20	A
Phosgene, gaseous	60	B
Phosgene, liquid	20	C
Phosphates (ammonium-, K-, Na- and others)	60	A
Phosphoric acid	40	A
Phosphoric acid	60	B
Phosphorus pentoxide	20	A
Propane	20	A
Propanol	60	A
Pyridine	20	A
Rhodanides (ammonium-, K-, Na- and others)	60	A
Salicylic acid	20	A
Silicates (K-)	20	A
Soap solution	40	A
Stearic acid	60	A
Sulphates (ammonium-, K-, Na- and others)	60	A
Sulphites (ammonium-, K-, Na- and others)	60	A
Sulphur dioxide, gaseous, dry and moist 100%	60	A
Sulphuric acid to 40%	20	C
Sulphuric acid to 50%	50	A
Sulphuric acid to 50%	60	A
Sulphuric acid to 80%	40	C
Sulphuric acid to 80%	60	B
Sulphuric acid to 96%	20	A
Sulphuric acid to 96%	60	B
Sulphuric acid, fuming (10% oleum)	20	C
Sulphurous acid	60	A
Tallow	60	A
Tan bark	20	A
Tar, free from aromatic hydrocarbons	20	A
Tartaric acid	60	A
Tetraethyl lead	60	A
Tetrafluoroboric acid	20	A
Tetrahydrofurane	20	C
Thickness	60	A
Toluene	20	A
Transformer oil	60	A
Trichloroethylene	20	C
Turpentine	20	A
Urea	60	C
Vegetable oils	40	A
Vinyl acetate	20	C
Viscose spinning solutions	60	A
Water	40	A
Water	60	B
Wine	40	A
Wine vinegar	50	A
Wood tar	20	C
Xylenes	20	C



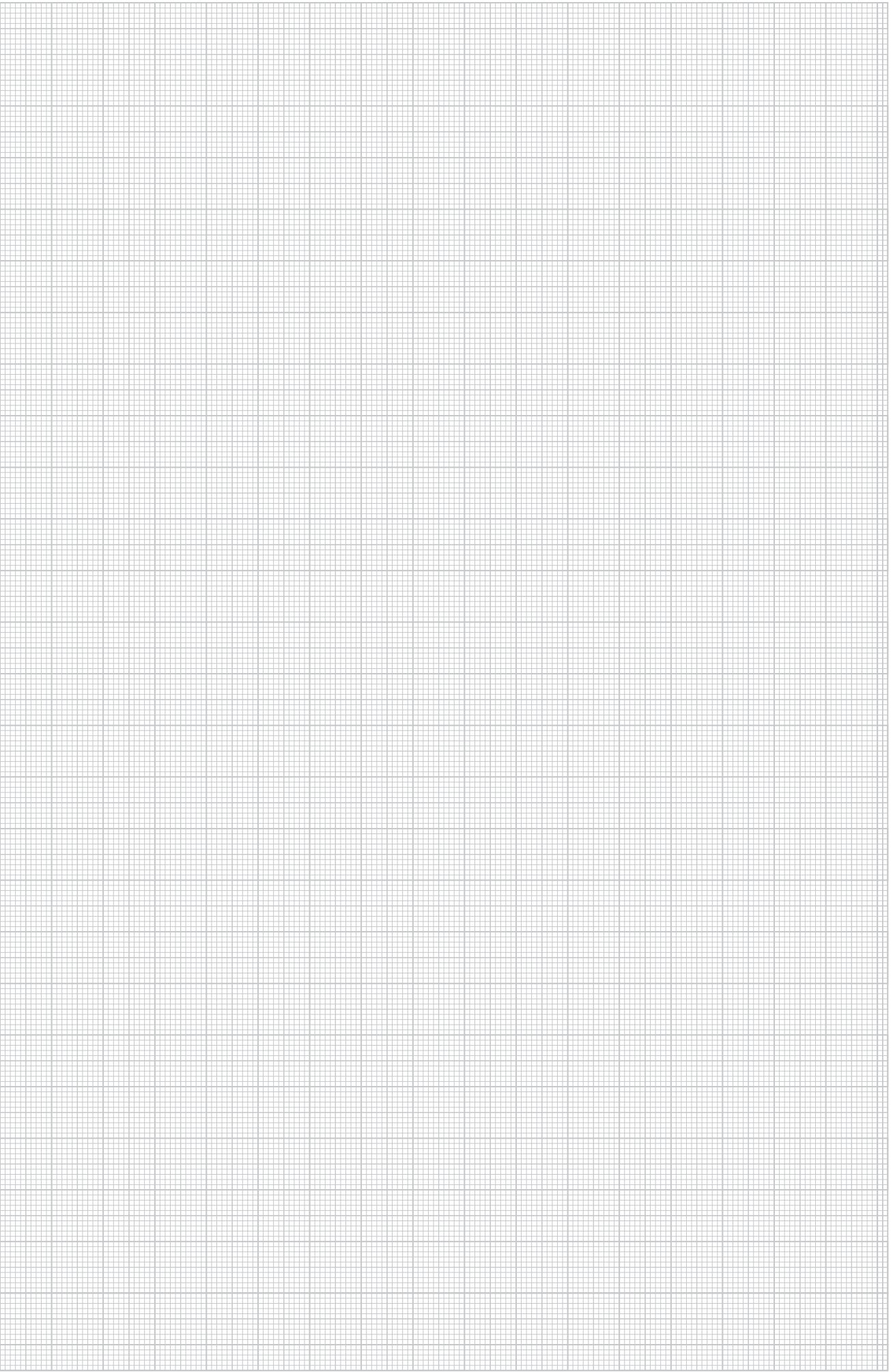

Material properties of the hard PVC used	
Material description according to DIN 7748	PVC-U-E-D-080-04-28
Tensile strength according to DIN 53 455	min. 40 N/mm ²
Elongation at tear according to DIN 53 455	min. 65%
Puncture strength according to DIN 53 481	min. 20 kV/mm
Surface resistance according to DIN 53 482	min. 10 10
Thermoforming resistance according to DIN 53 460/B	min. 75 °C
Temperature resistance in the application max.	65 °C
Flammability	according to UL 94 Level V-0
Hot-wire test	according to DIN IEC 695 960 °C
Material classification	to DIN EN 4102, Class B1 and B2-tested







Device installation trunking accessories

	Fastening panels and mounting accessories	304
	Wall cover	307
	Noise insulation	313
	Supply trunking	313



Device installation trunking accessories



Fastening panels

Type	Version	Pack.	Weight	Item No.
		pcs	kg/100 pcs.	
BKN50 80	53–83 mm	1	0.000	6288 00 1
BKN75 125	78–127 mm	1	0.000	6288 00 3
BKN120 205	120–205 mm	1	0.000	6288 00 5
BKN200 350	198–351 mm	1	0.000	6288 00 7

ST Steel **FS** Strip-galvanised /pc.

Fastening panel for mounting device installation trunking on skirting board construction and as a support for the convection grid. The fixing panel can be used for all device installation trunking systems with 80 mm and 110 mm system openings; GEK-S, GEK-A and GEK-K in conjunction with a wall panel adapter.

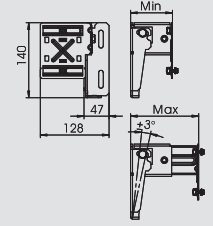

Wall panel adapter for GK, trunking height 110 mm

Type	For trunking dimensions	Pack.	Weight	Item No.
		pcs	kg/100 pcs.	
KS70110	70x110 mm	1	22.000	6279 80 2

ST Steel **FS** Strip-galvanised /pc.

Wall panel adapter for mounting the GK70110 device installation trunking on wall panels.

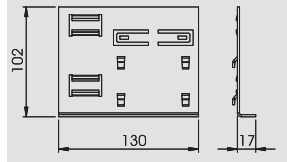

Wall panel adapter for GK, trunking height 130 mm

Type	For trunking dimensions	Pack.	Weight	Item No.
		pcs	kg/100 pcs.	
KS70130	70x130 mm	1	26.100	6279 80 4

ST Steel **FS** Strip-galvanised /pc.

Wall panel adapter for mounting the GK70130 device installation trunking on wall panels.

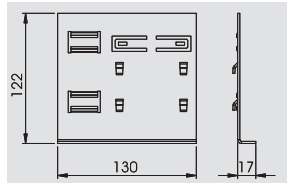

Wall panel adapter for GK, trunking height 170 mm

Type	For trunking dimensions	Pack.	Weight	Item No.
		pcs	kg/100 pcs.	
KS70170	70x170 mm	1	34.300	6279 80 6

ST Steel **FS** Strip-galvanised /pc.

Wall panel adapter for mounting the GK70170 device installation trunking on wall panels.

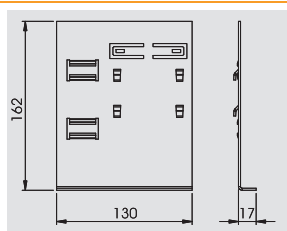

Connection profile for trunking height 170 mm

Type	Dimension h	Pack.	Weight	Item No.
	mm	pcs	kg/100 pcs.	
KSP170	152	1	23.500	6279 81 0

ST Steel **FS** Strip-galvanised /pc.

Stabilisation profile for panel mounting of device installation trunking of nominal height 170.

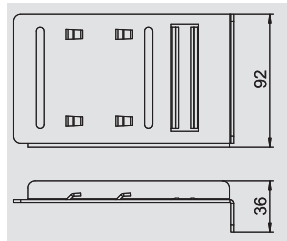

Connection profile for trunking height 210 mm

Type	Dimension h	Pack.	Weight	Item No.
	mm	pcs	kg/100 pcs.	
KSP210	192	1	30.000	6279 81 2

ST Steel **FS** Strip-galvanised /pc.

Stabilisation profile for panel mounting of device installation trunking of nominal height 210.

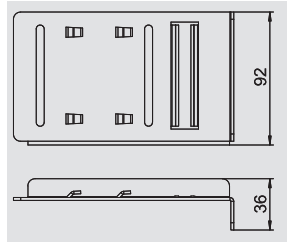

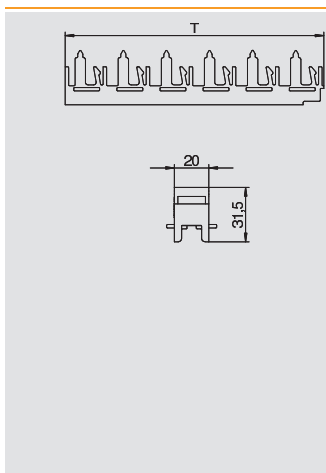

Profile connector, horizontal

Type	Length mm	Number of profiles	Pack.	Weight	Item No.
			pcs	kg/100 pcs.	
PV N3 50H	50	2	1	0.730	6288 10 0
PV N3 75H	75	3	1	1.080	6288 10 2
PV N3 100H	100	4	1	1.430	6288 10 4
PV N3 125H	125	5	1	1.800	6288 10 6
PV N3 150H	150	6	1	2.130	6288 10 8
PV N3 175H	175	7	1	2.470	6288 11 0
PV N3 200H	200	8	1	2.830	6288 11 2
PV N3 225H	225	9	1	3.170	6288 11 4
PV N3 250H	250	10	1	3.540	6288 11 6
PV N3 275H	275	11	1	3.900	6288 11 8
PV N3 300H	300	12	1	4.300	6288 12 0

/pc.

Horizontal profile connector with guide slits to lock convection grid profiles. The profile connector is mounted on the fastening panel using the clamp, type SP3.

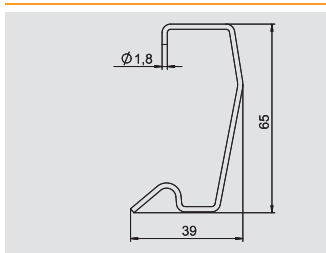

Clamp

Type	Pack.	Weight	Item No.
	pcs	kg/100 pcs.	
SP3	1	0.260	6279 80 0

ST Steel **FS** Strip-galvanised /pc.

Clamp to lock supports between the convection grid and the fixing panel. Suitable for fixing panels for windowsill thickness 23.5.

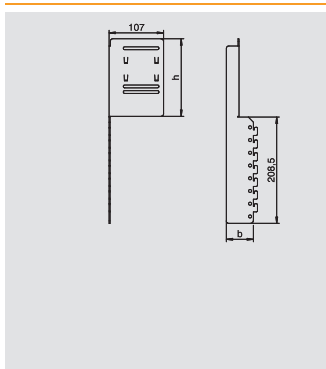

Mounting and connection profile for convection grids, trunking depth 70 mm

Type	For trunking dimensions	Dimension h	Dimension b	Pack.	Weight	Item No.
		mm	mm		pcs	
MVKG70130	70 x 130	110	68	1	38.000	6279 82 0
MVKG70170	70 x 170	150	68	1	43.000	6279 82 2
MVKG70210	70 x 210	190	68	1	50.000	6279 82 4

ST Steel **FS** Strip-galvanised /pc.

Mounting and connection profile for panel mounting of device installation trunking in conjunction with vertical convection grids. The installation and connection profile is locked onto the fixing panel and accepts the profile connector, type PVV/N2... vertically. Please observe the trunking dimensions.

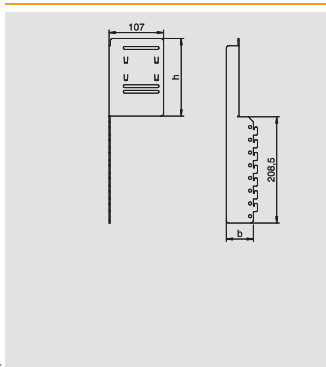

Mounting and connection profile for convection grids, trunking depth 90 mm

Type	For trunking dimensions	Dimension h	Dimension b	Pack.	Weight	Item No.
		mm	mm		pcs	
MVKG90130	90 x 130	110	88	1	44.000	6279 82 6
MVKG90170	90 x 170	150	88	1	50.000	6279 82 8
MVKG90210	90 x 210	190	88	1	57.000	6279 83 0

ST Steel **FS** Strip-galvanised /pc.

Mounting and connection profile for panel mounting of device installation trunking in conjunction with vertical convection grids. The installation and connection profile is locked onto the fixing panel and accepts the profile connector, type PVV/N2... vertically. Please observe the trunking dimensions.



Device installation trunking accessories



Profile connector, vertical

Type	Length mm	Number of profiles	Pack.	Weight	Item No.
			pcs	kg/100 pcs.	
PVV N2 100	100	4	1	6.000	6288 03 0
PVV N2 125	125	5	1	7.500	6288 03 2
PVV N2 150	150	6	1	9.000	6288 03 4
PVV N2 175	175	7	1	10.500	6288 03 6
PVV N2 200	200	8	1	12.000	6288 03 8
PVV N2 225	225	9	1	13.500	6288 04 0
PVV N2 275	275	11	1	16.000	6288 04 2
PVV N2 300	300	12	1	17.600	6288 07 0
PVV N2 325	325	13	1	18.900	6288 07 2
PVV N2 350	350	14	1	20.700	6288 07 4
PVV N2375	375	15	1	22.800	6288 07 6
PVV N2 400	400	16	1	24.810	6288 07 8
PVV N2 425	425	17	1	25.500	6288 08 0
PVV N2 450	450	18	1	27.320	6288 08 2
PVV N2 475	475	19	1	28.500	6288 04 4
PVV N2 500	500	20	1	29.600	6288 08 4
PVV N2 525	525	21	1	31.000	6288 08 6
PVV N2 550	550	22	1	33.000	6288 04 6
PVV N2 575	575	23	1	34.500	6288 04 8
PVV N2 600	600	24	1	36.000	6288 05 0
PVV N2 625	625	25	1	37.500	6288 05 2
PVV N2 650	650	26	1	39.000	6288 05 4
PVV N2 675	675	27	1	40.500	6288 05 6
PVV N2 700	700	28	1	43.000	6288 05 8
PVV N2 725	725	29	1	44.500	6288 06 0
PVV N2 750	750	30	1	46.000	6288 06 2
PVV N2 775	775	31	1	46.800	6288 08 8
PVV N2 800	800	32	1	51.200	6288 09 0
PVV N2 825	825	33	1	49.050	6288 09 2
PVV N2 850	850	34	1	51.000	6288 06 4
PVV N2 875	875	35	1	52.500	6288 06 6

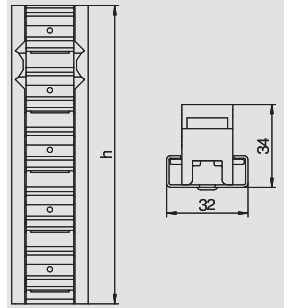

/pc.

Vertical profile connector with guide slits to lock convection grid profiles for the creation of a compact grid unit. The vertical convection grids can run some way down the front side of the trunking, although a gap should be left near the floor for cleaning, or should be run to the floor and fastened with the BVL floor panel. This version represents a variant of the convector panelling. Alternatively to the convection grid profiles, heating convector panelling can also be created with closed sheet steel panelling.



Floor panel

Type	Pack.	Weight	Item No.
	pcs	kg/100 pcs.	
BVL	1	4.000	6288 18 0

/pc.

The BVL floor holder is used to fasten vertical profile connectors of type PVV/N2... on the floor.

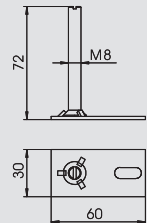

Mounting and connection profile for convector panelling, trunking depth 70 mm

Type	Colour	Pack.	Weight	Item No.
		pcs	kg/100 pcs.	
MVKV70130	—	1	0.000	6279 83 2
MVKV70170	—	1	0.000	6279 83 4
MVKV70210	—	1	0.000	6279 83 6

ST Steel **FS** Strip-galvanised /pc.

Mounting and connection profile for panel mounting of device installation ducts in conjunction with vertical convector panelling. The mounting and connection profile is locked onto the fastening panel and accepts the guide plates for convector panelling.

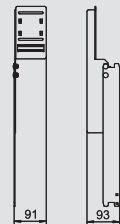

Mounting and connection profile for convector panelling, trunking depth 90 mm

Type	Colour	Pack.	Weight	Item No.
		pcs	kg/100 pcs.	
MVKV90130	—	1	0.000	6279 83 8
MVKV90170	—	1	0.000	6279 84 0
MVKV90210	—	1	0.000	6279 84 2

ST Steel **FS** Strip-galvanised /pc.

Mounting and connection profile for panel mounting of device installation ducts in conjunction with vertical convector panelling. The mounting and connection profile is locked onto the fastening panel and accepts the guide plates for convector panelling.

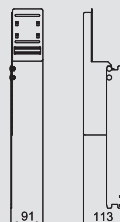

Device installation trunking accessories

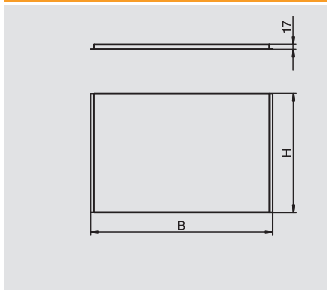

Convector panelling

Type	Colour	Pack.	Weight	Item No.
		pcs	kg/100 pcs.	
KVV	Pure white	1	0.000	
ST	Steel			/pc.

Convector panelling for closed vertical covering of convector heaters. To achieve an optimum overall picture of room design and to meet the different resulting requirements of the appropriate application, we would request you contact us regarding the planning and ordering of the convector panelling.

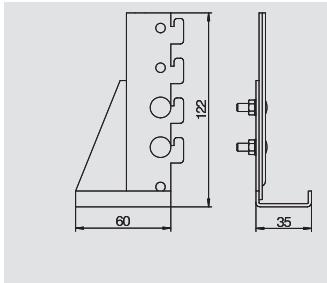

Floor panel

Type	Colour	Pack.	Weight	Item No.
		pcs	kg/100 pcs.	
BVB125	—	1	15.500	6287 80 0
ST	Steel			/pc.

Floor panel as lower closure of convector panelling. This version is only required when closed convector panelling forming the bottom end to the floor is to be additionally provided with vertical convection grid profiles. The floor panel is suitable for accepting a profile connector PVV/N2... for five convection grid profiles.

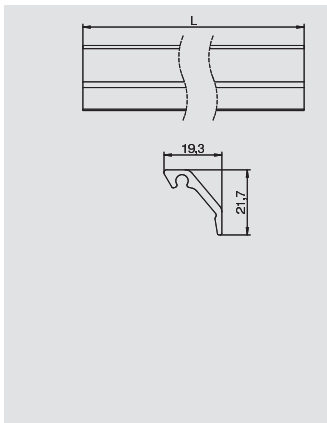

Convection grid profile

Type	Colour	Surface finish	Length	Pack.	Weight	Item No.
			mm	m	kg/100 m	
KG2RW	Pure white	—	2,000	40	23.100	6287 70 0
KG2CW	Cream	—	2,000	40	23.100	6287 70 1
KG2LGR	Light grey	—	2,000	40	23.100	6287 70 2
KG2RW	Pure white	—	3,000	60	23.100	6287 71 0
KG2CW	Cream	—	3,000	60	23.100	6287 71 1
KG2LGR	Light grey	—	3,000	60	23.100	6287 71 2
KG2EL	—	Anodised	3,000	60	21.900	6287 72 3
KG2EL	—	Anodised	2,000	40	21.900	6287 73 3
AL	Aluminium	EL Anodised				/m

Sloping convection grid, for optically attractive closing of spaces between the device installation trunking and the wall. The convection grid profiles are suitable for horizontal and vertical mounting.

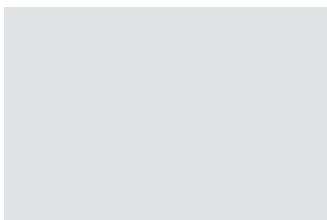

Coupling pins

Type	Colour	Pack.	Weight	Item No.
		pcs	kg/100 pcs.	
8VS4	—	100	0.740	6287 81 0
				/pc.

Coupling pin to connect convection grid profiles.

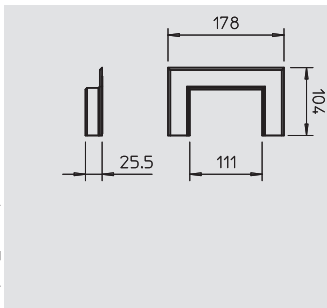

PVC wall cover, open, 70110

Type	Colour	Dimension a	Dimension b	Pack.	Weight	Item No.
		mm	mm	pcs	kg/100 pcs.	
G-KWAO70110RW	Pure white	178	104	1	6.300	6274 81 0
G-KWAO70110CW	Cream	178	104	1	6.300	6274 81 1
G-KWAO70110LGR	Light grey	178	104	1	6.300	6274 81 2
G-KWAO70110GR	Stone grey	178	104	1	6.300	6274 81 6
ABS/ASA	Acrylonitrile butadiene styrene					/pc.

Wall cover, open, to close wall penetrations during wall mounting. Please specify colour shade for the aluminium version.

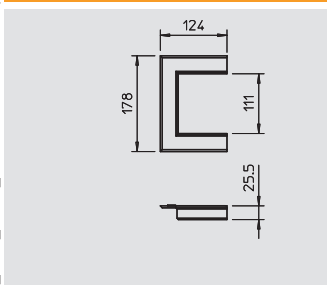

PVC wall cover, open, 90110

Type	Colour	Dimension a	Dimension b	Pack.	Weight	Item No.
		mm	mm	pcs	kg/100 pcs.	
G-KWAO90110RW	Pure white	178	124	1	7.100	6274 91 0
G-KWAO90110CW	Cream	178	124	1	7.100	6274 91 1
G-KWAO90110LGR	Light grey	178	124	1	7.100	6274 91 2
ABS/ASA	Acrylonitrile butadiene styrene					/pc.

Wall cover, open, to close wall penetrations during wall mounting. Please specify colour shade for the aluminium version.



Device installation trunking accessories

PVC wall cover, open, 70130

Type	Colour	Dimension a mm	Dimension b mm	Pack.	Weight	Item No.
				pcs	kg/100 pcs.	
G-KWAO70130RW	Pure white	198	104	1	6.500	6274 82 0
G-KWAO70130CW	Cream	198	104	1	6.500	6274 82 1
G-KWAO70130LGR	Light grey	198	104	1	6.500	6274 82 2
G-KWAO70130GR	Stone grey	198	104	1	6.500	6274 82 6

ABS/ASA Acrylonitrile butadiene styrene

/pc.

Wall cover, open, to close wall penetrations during wall mounting.
Please specify colour shade for the aluminium version.

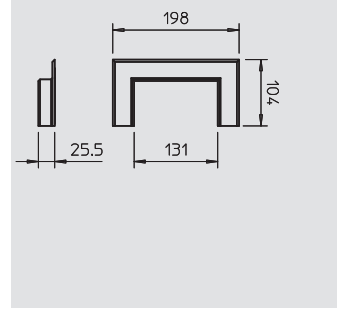

PVC wall cover, open, 90130

Type	Colour	Dimension a mm	Dimension b mm	Pack.	Weight	Item No.
				pcs	kg/100 pcs.	
G-KWAO90130RW	Pure white	198	124	1	7.300	6274 92 0
G-KWAO90130CW	Cream	198	124	1	7.300	6274 92 1
G-KWAO90130LGR	Light grey	198	124	1	7.300	6274 92 2

ABS/ASA Acrylonitrile butadiene styrene

/pc.

Wall cover, open, to close wall penetrations during wall mounting.
Please specify colour shade for the aluminium version.

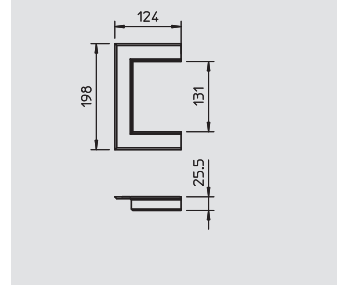

PVC wall cover, open, 70170

Type	Colour	Dimension a mm	Dimension b mm	Pack.	Weight	Item No.
				pcs	kg/100 pcs.	
G-KWAO70170RW	Pure white	238	104	1	7.100	6274 83 0
G-KWAO70170CW	Cream	238	104	1	7.100	6274 83 1
G-KWAO70170LGR	Light grey	238	104	1	7.100	6274 83 2
G-KWAO70170GR	Stone grey	238	104	1	7.100	6274 83 6

ABS/ASA Acrylonitrile butadiene styrene

/pc.

Wall cover, open, to close wall penetrations during wall mounting.
Please specify colour shade for the aluminium version.

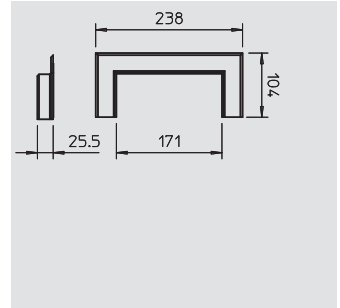

PVC wall cover, open, 90170

Type	Colour	Dimension a mm	Dimension b mm	Pack.	Weight	Item No.
				pcs	kg/100 pcs.	
G-KWAO90170RW	Pure white	238	124	1	7.500	6274 93 0
G-KWAO90170CW	Cream	238	124	1	7.500	6274 93 1
G-KWAO90170LGR	Light grey	238	124	1	7.500	6274 93 2

ABS/ASA Acrylonitrile butadiene styrene

/pc.

Wall cover, open, to close wall penetrations during wall mounting.
Please specify colour shade for the aluminium version.

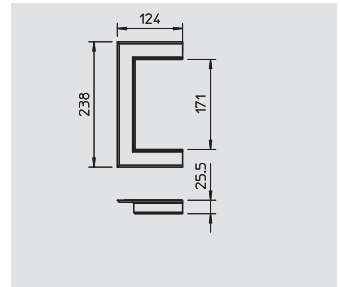

PVC wall cover, open, 70210

Type	Colour	Dimension a mm	Dimension b mm	Pack.	Weight	Item No.
				pcs	kg/100 pcs.	
G-KWAO70210RW	Pure white	278	104	1	7.500	6274 84 0
G-KWAO70210CW	Cream	278	104	1	7.500	6274 84 1
G-KWAO70210LGR	Light grey	278	104	1	7.500	6274 84 2

ABS/ASA Acrylonitrile butadiene styrene

/pc.

Wall cover, open, to close wall penetrations during wall mounting.
Please specify colour shade for the aluminium version.

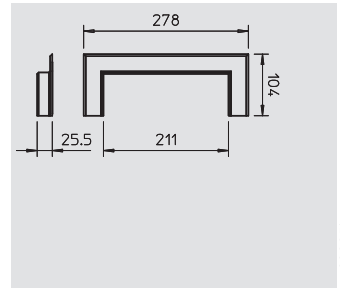

PVC wall cover, open, 90210

Type	Colour	Dimension a mm	Dimension b mm	Pack.	Weight	Item No.
				pcs	kg/100 pcs.	
G-KWAO90210RW	Pure white	278	124	1	7.800	6274 94 0
G-KWAO90210CW	Cream	278	124	1	7.800	6274 94 1
G-KWAO90210LGR	Light grey	278	124	1	7.800	6274 94 2

ABS/ASA Acrylonitrile butadiene styrene

/pc.

Wall cover, open, to close wall penetrations during wall mounting.
Please specify colour shade for the aluminium version.

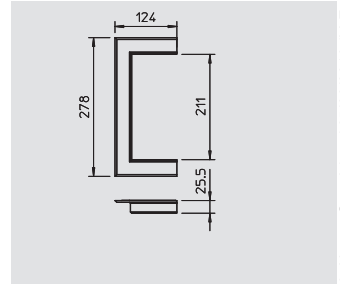

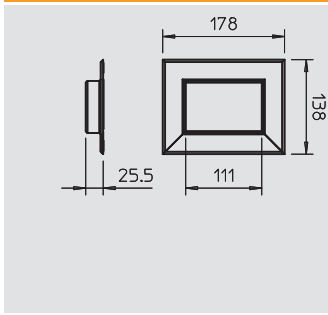

PVC wall cover, closed, 70110

Type	Colour	Dimension a mm	Dimension b mm	Pack. pcs	Weight kg/100 pcs.	Item No.
G-KWAG70110RW	Pure white	178	138	1	8.900	6274 85 0
G-KWAG70110CW	Cream	178	138	1	8.900	6274 85 1
G-KWAG70110LGR	Light grey	178	138	1	8.900	6274 85 2
G-KWAG70110GR	Stone grey	178	138	1	8.900	6274 85 6

ABS/ASA Acrylonitrile butadiene styrene

/pc.

Wall cover, closed, to close wall penetrations during panel mounting.
Please specify colour shade for the aluminium version.

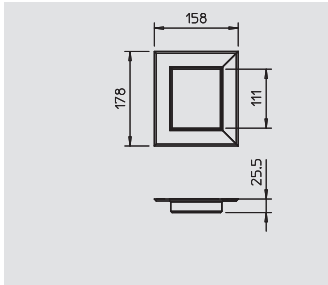

PVC wall cover, closed, 90110

Type	Colour	Dimension a mm	Dimension b mm	Pack. pcs	Weight kg/100 pcs.	Item No.
G-KWAG90110RW	Pure white	178	158	1	9.600	6274 95 0
G-KWAG90110CW	Cream	178	158	1	9.600	6274 95 1
G-KWAG90110LGR	Light grey	178	158	1	9.600	6274 95 2

ABS/ASA Acrylonitrile butadiene styrene

/pc.

Wall cover, closed, to close wall penetrations during panel mounting.
Please specify colour shade for the aluminium version.

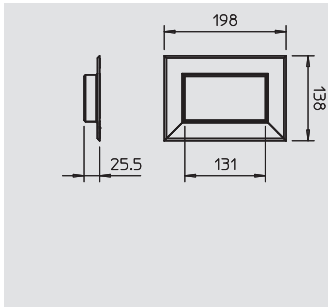

PVC wall cover, closed, 70130

Type	Colour	Dimension a mm	Dimension b mm	Pack. pcs	Weight kg/100 pcs.	Item No.
G-KWAG70130RW	Pure white	198	138	1	9.400	6274 86 0
G-KWAG70130CW	Cream	198	138	1	9.400	6274 86 1
G-KWAG70130LGR	Light grey	198	138	1	9.400	6274 86 2
G-KWAG70130GR	Stone grey	198	138	1	9.400	6274 86 6

ABS/ASA Acrylonitrile butadiene styrene

/pc.

Wall cover, closed, to close wall penetrations during panel mounting.
Please specify colour shade for the aluminium version.

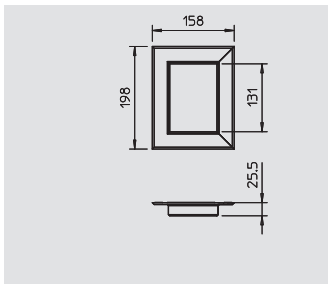

PVC wall cover, closed, 90130

Type	Colour	Dimension a mm	Dimension b mm	Pack. pcs	Weight kg/100 pcs.	Item No.
G-KWAG90130RW	Pure white	198	158	1	10.100	6274 96 0
G-KWAG90130CW	Cream	198	158	1	10.100	6274 96 1
G-KWAG90130LGR	Light grey	198	158	1	10.100	6274 96 2

ABS/ASA Acrylonitrile butadiene styrene

/pc.

Wall cover, closed, to close wall penetrations during panel mounting.
Please specify colour shade for the aluminium version.

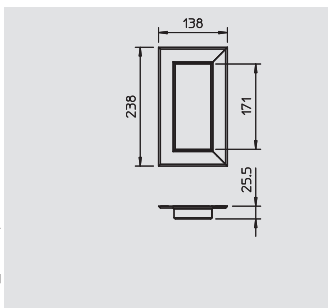

PVC wall cover, closed, 70170

Type	Colour	Dimension a mm	Dimension b mm	Pack. pcs	Weight kg/100 pcs.	Item No.
G-KWAG70170RW	Pure white	238	138	1	10.400	6274 87 0
G-KWAG70170CW	Cream	238	138	1	10.400	6274 87 1
G-KWAG70170LGR	Light grey	238	138	1	10.400	6274 87 2
G-KWAG70170GR	Stone grey	238	138	1	10.400	6274 87 6

ABS/ASA Acrylonitrile butadiene styrene

/pc.

Wall cover, closed, to close wall penetrations during panel mounting.
Please specify colour shade for the aluminium version.

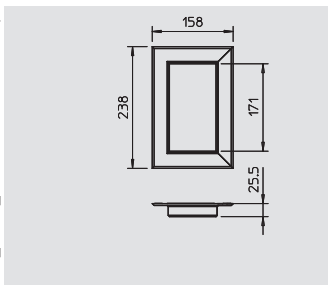

PVC wall cover, closed, 90170

Type	Colour	Dimension a mm	Dimension b mm	Pack. pcs	Weight kg/100 pcs.	Item No.
G-KWAG90170RW	Pure white	238	158	1	11.100	6274 97 0
G-KWAG90170CW	Cream	238	158	1	11.100	6274 97 1
G-KWAG90170LGR	Light grey	238	158	1	11.100	6274 97 2

ABS/ASA Acrylonitrile butadiene styrene

/pc.

Wall cover, closed, to close wall penetrations during panel mounting.
Please specify colour shade for the aluminium version.



Device installation trunking accessories

PVC wall cover, closed, 70210

Type	Colour	Dimension a	Dimension b	Pack.	Weight	Item No.
		mm	mm			
G-KWAG70210RW	Pure white	278	138	1	11.400	6274 88 0
G-KWAG70210CW	Cream	278	138	1	11.400	6274 88 1
G-KWAG70210LGR	Light grey	278	138	1	11.400	6274 88 2

ABS/ASA Acrylonitrile butadiene styrene

/pc.

Wall cover, closed, to close wall penetrations during panel mounting.
Please specify colour shade for the aluminium version.

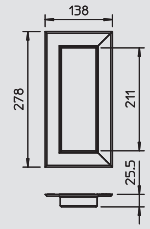

PVC wall cover, closed, 90210

Type	Colour	Dimension a	Dimension b	Pack.	Weight	Item No.
		mm	mm			
G-KWAG90210RW	Pure white	278	158	1	12.200	6274 98 0
G-KWAG90210CW	Cream	278	158	1	12.200	6274 98 1
G-KWAG90210LGR	Light grey	278	158	1	12.200	6274 98 2

ABS/ASA Acrylonitrile butadiene styrene

/pc.

Wall cover, closed, to close wall penetrations during panel mounting.
Please specify colour shade for the aluminium version.

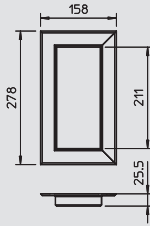

Aluminium wall cover, open, 70110

Type	Colour	Dimension a	Dimension b	Pack.	Weight	Item No.
		mm	mm			
G-AWAO70110RW	Pure white	178	104	1	10.300	6278 80 0
G-AWAO70110CW	Cream	178	104	1	10.300	6278 80 1
G-AWAO70110LGR	Light grey	178	104	1	10.300	6278 80 2

Al Aluminium

/pc.

Wall cover, open, to close wall penetrations during wall mounting.
Please specify colour shade for the aluminium version.

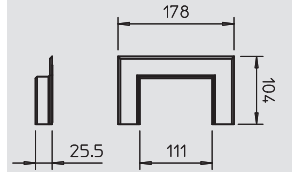

Aluminium wall cover, open, 90110

Type	Colour	Dimension a	Dimension b	Pack.	Weight	Item No.
		mm	mm			
G-AWAO90110RW	Pure white	178	124	1	11.600	6278 88 0
G-AWAO90110CW	Cream	178	124	1	11.600	6278 88 1
G-AWAO90110LGR	Light grey	178	124	1	11.600	6278 88 2

Al Aluminium

/pc.

Wall cover, open, to close wall penetrations during wall mounting.
Please specify colour shade for the aluminium version.

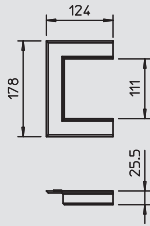

Aluminium wall cover, open, 70130

Type	Colour	Dimension a	Dimension b	Pack.	Weight	Item No.
		mm	mm			
G-AWAO70130RW	Pure white	198	104	1	10.900	6278 81 0
G-AWAO70130CW	Cream	198	104	1	10.900	6278 81 1
G-AWAO70130LGR	Light grey	198	104	1	10.900	6278 81 2

Al Aluminium

/pc.

Wall cover, open, to close wall penetrations during wall mounting.
Please specify colour shade for the aluminium version.

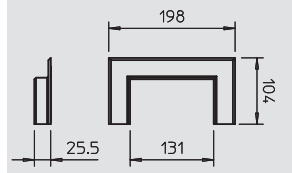

Aluminium wall cover, open, 90130

Type	Colour	Dimension a	Dimension b	Pack.	Weight	Item No.
		mm	mm			
G-AWAO90130RW	Pure white	198	124	1	12.300	6278 89 0
G-AWAO90130CW	Cream	198	124	1	12.300	6278 89 1
G-AWAO90130LGR	Light grey	198	124	1	12.300	6278 89 2

Al Aluminium

/pc.

Wall cover, open, to close wall penetrations during wall mounting.
Please specify colour shade for the aluminium version.

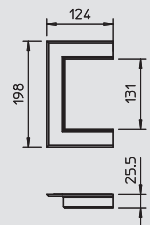

Device installation trunking accessories

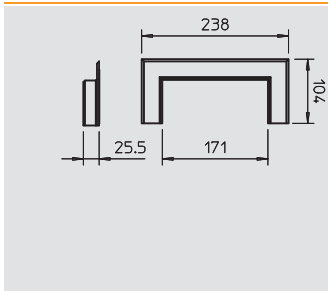

Aluminium wall cover, open, 70170

Type	Colour	Dimension a mm	Dimension b mm	Pack. pcs	Weight kg/100 pcs.	Item No.
G-AWAO70170RW	Pure white	238	104	1	12.300	6278 82 0
G-AWAO70170CW	Cream	238	104	1	12.300	6278 82 1
G-AWAO70170LGR	Light grey	238	104	1	12.300	6278 82 2

Al Aluminium

/pc.

Wall cover, open, to close wall penetrations during wall mounting.
Please specify colour shade for the aluminium version.

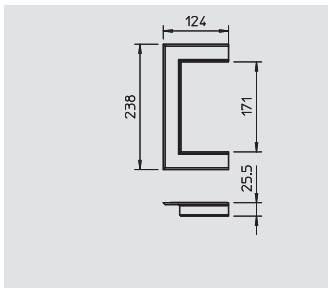

Aluminium wall cover, open, 90170

Type	Colour	Dimension a mm	Dimension b mm	Pack. pcs	Weight kg/100 pcs.	Item No.
G-AWAO90170RW	Pure white	238	124	1	13.600	6279 00 0
G-AWAO90170CW	Cream	238	124	1	13.600	6279 00 1
G-AWAO90170LGR	Light grey	238	124	1	13.600	6279 00 2

Al Aluminium

/pc.

Wall cover, open, to close wall penetrations during wall mounting.
Please specify colour shade for the aluminium version.

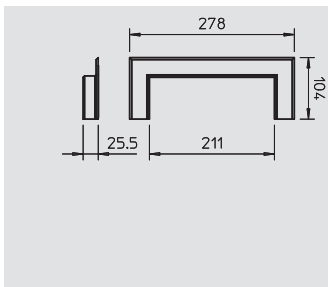

Aluminium wall cover, open, 70210

Type	Colour	Dimension a mm	Dimension b mm	Pack. pcs	Weight kg/100 pcs.	Item No.
G-AWAO70210RW	Pure white	278	104	1	13.600	6278 83 0
G-AWAO70210LGR	Light grey	278	104	1	13.600	6278 83 2
G-AWAO70210CW	Cream	278	104	1	13.600	6278 83 1

Al Aluminium

/pc.

Wall cover, open, to close wall penetrations during wall mounting.
Please specify colour shade for the aluminium version.

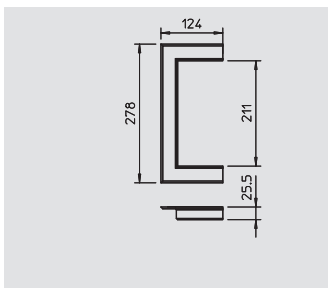

Aluminium wall cover, open, 90210

Type	Colour	Dimension a mm	Dimension b mm	Pack. pcs	Weight kg/100 pcs.	Item No.
G-AWAO90210RW	Pure white	278	124	1	14.900	6279 01 0
G-AWAO90210CW	Cream	278	124	1	14.900	6279 01 1
G-AWAO90210LGR	Light grey	278	124	1	14.900	6279 01 2

Al Aluminium

/pc.

Wall cover, open, to close wall penetrations during wall mounting.
Please specify colour shade for the aluminium version.

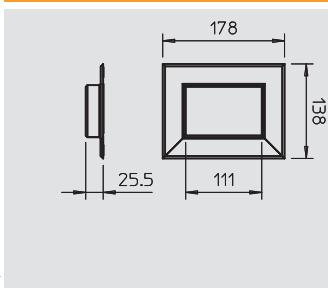

Aluminium wall cover, closed, 70110

Type	Colour	Dimension a mm	Dimension b mm	Pack. pcs	Weight kg/100 pcs.	Item No.
G-AWAG70110RW	Pure white	178	138	1	16.000	6278 84 0
G-AWAG70110CW	Cream	178	138	1	16.000	6278 84 1
G-AWAG70110LGR	Light grey	178	138	1	16.000	6278 84 2

Al Aluminium

/pc.

Wall cover, closed, to close wall penetrations during panel mounting.
Please specify colour shade for the aluminium version.

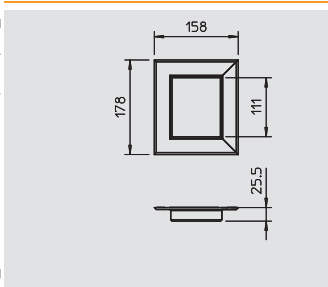

Aluminium wall cover, closed, 90110

Type	Colour	Dimension a mm	Dimension b mm	Pack. pcs	Weight kg/100 pcs.	Item No.
G-AWAG90110RW	Pure white	178	158	1	17.400	6279 02 0
G-AWAG90110CW	Cream	178	158	1	17.400	6279 02 1
G-AWAG90110LGR	Light grey	178	158	1	17.400	6279 02 2

Al Aluminium

/pc.

Wall cover, closed, to close wall penetrations during panel mounting.
Please specify colour shade for the aluminium version.

06_LFS_Katalog_2010_Neuer_Stand / en / 25/02/2010 (LLE:export_00995)

Device installation trunking accessories

Device installation trunking accessories

Aluminium wall cover, closed, 70130

Type	Colour	Dimension a mm	Dimension b mm	Pack. pcs	Weight kg/100 pcs.	Item No.
G-AWAG70130RW	Pure white	198	138	1	17.300	6278 85 0
G-AWAG70130CW	Cream	198	138	1	17.300	6278 85 1
G-AWAG70130LGR	Light grey	198	138	1	17.300	6278 85 2

Al Aluminium /pc.

Wall cover, closed, to close wall penetrations during panel mounting.
Please specify colour shade for the aluminium version.

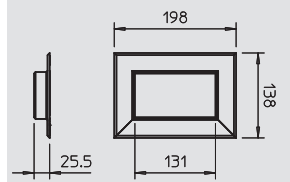

Aluminium wall cover, closed, 90130

Type	Colour	Dimension a mm	Dimension b mm	Pack. pcs	Weight kg/100 pcs.	Item No.
G-AWAG90130RW	Pure white	198	158	1	18.700	6279 03 0
G-AWAG90130CW	Cream	198	158	1	18.700	6279 03 1
G-AWAG90130LGR	Light grey	198	158	1	18.700	6279 03 2

Al Aluminium /pc.

Wall cover, closed, to close wall penetrations during panel mounting.
Please specify colour shade for the aluminium version.

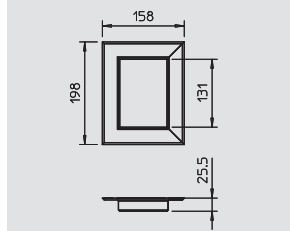

Aluminium wall cover, closed, 70170

Type	Colour	Dimension a mm	Dimension b mm	Pack. pcs	Weight kg/100 pcs.	Item No.
G-AWAG70170RW	Pure white	238	138	1	20.000	6278 86 0
G-AWAG70170CW	Cream	238	138	1	20.000	6278 86 1
G-AWAG70170LGR	Light grey	238	138	1	20.000	6278 86 2

Al Aluminium /pc.

Wall cover, closed, to close wall penetrations during panel mounting.
Please specify colour shade for the aluminium version.

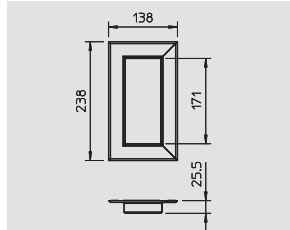

Aluminium wall cover, closed, 90170

Type	Colour	Dimension a mm	Dimension b mm	Pack. pcs	Weight kg/100 pcs.	Item No.
G-AWAG90170RW	Pure white	238	158	1	21.300	6279 04 0
G-AWAG90170CW	Cream	238	158	1	21.300	6279 04 1
G-AWAG90170LGR	Light grey	238	158	1	21.300	6279 04 2

Al Aluminium /pc.

Wall cover, closed, to close wall penetrations during panel mounting.
Please specify colour shade for the aluminium version.

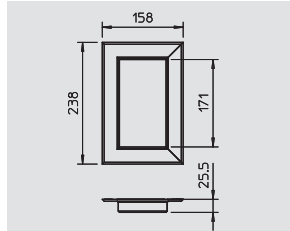

Aluminium wall cover, closed, 70210

Type	Colour	Dimension a mm	Dimension b mm	Pack. pcs	Weight kg/100 pcs.	Item No.
G-AWAG70210RW	Pure white	278	138	1	22.600	6278 87 0
G-AWAG70210CW	Cream	278	138	1	22.600	6278 87 1
G-AWAG70210LGR	Light grey	278	138	1	22.600	6278 87 2

Al Aluminium /pc.

Wall cover, closed, to close wall penetrations during panel mounting.
Please specify colour shade for the aluminium version.

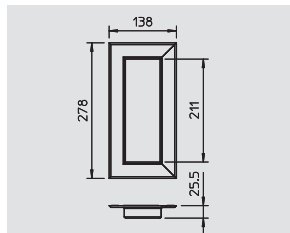

Aluminium wall cover, closed, 90210

Type	Colour	Dimension a mm	Dimension b mm	Pack. pcs	Weight kg/100 pcs.	Item No.
G-AWAG90210RW	Pure white	278	158	1	23.900	6279 05 0
G-AWAG90210CW	Cream	278	158	1	23.900	6279 05 1
G-AWAG90210LGR	Light grey	278	158	1	23.900	6279 05 2

Al Aluminium /pc.

Wall cover, closed, to close wall penetrations during panel mounting.
Please specify colour shade for the aluminium version.

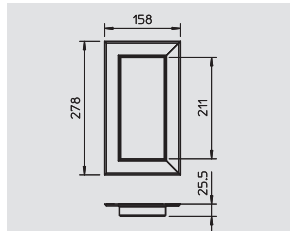

Device installation trunking accessories

Noise limit barrier

Type	Length	Pack.	Weight	Item No.
	mm	pcs	kg/100 pcs.	
7LSB	300	15	3.867	6288 65 0



/pc.

The noise limit barrier is used to reduce the transmission of airborne noise, e.g. when the trunking system is run through a wall between two offices. The noise limit barrier is made of rock wool, which, when delivered, has a diameter of approx. 50 mm and a length of approx. 300 mm. The material need not be greatly compressed during installation.

The attenuation is approx. 40 dB.

Noise protection, sold by the metre

Type	Pack.	Weight	Item No.
	m	kg/100 m	
7LSB M	1	0.000	6288 65 1



/m

The noise protection barrier is used to reduce airborne transmission, e.g. when running a duct system through wall penetrations between two offices. The noise protection barrier is made of rock wool, which, when delivered, has dimensions of approx. 50 mm and a length of 30 m. The required lengths can be cut off using shears. During mounting, the material need not be greatly compacted.

The attenuation is approx. 40 dB.

Supply trunking

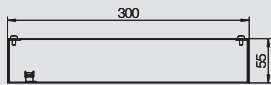

Type	Colour	Length	Pack.	Weight	Item No.
		mm	pcs	kg/100 pcs.	
EK300CW	Cream	850	1	568.000	6246 05 2
EK300RW	Pure white	850	1	568.000	6246 08 7



ST Steel





/pc.

Supply trunking for cable routing to the device installation trunking. Complete with protective conduction connection terminal and removable, screwed-on cover.





Directories

	Alphabetical table of contents	360
	Numeric directory	366
	Type listing	376
	Terms and conditions of sale and delivery	403



Alphabetical table of contents

A

Accessory mounting box, 122
Adapter for switch installation rotated through 90°, 346
Adapter stabiliser for ISST70140, 319
Adapter stabiliser for ISST70140B, 321
Aluminium cover, 266, 269, 272, 275, 278, 281, 284, 287, 296, 299
Aluminium cover, size 50 track, 291, 294
Aluminium cover, size 80 track, 290, 293
Aluminium external corner cover, 267, 270, 273, 276, 279, 282, 285, 288, 297, 300
Aluminium external corner cover, size 50 track, 291, 294
Aluminium external corner cover, size 80 track, 291, 294
Aluminium flat angle cover, 267, 270, 273, 276, 279, 282, 285, 288, 297, 300
Aluminium flat angle cover, size 50 track, 292, 295
Aluminium flat angle cover, size 80 track, 292, 295
Aluminium wall cover, closed, 70110, 311
Aluminium wall cover, closed, 70130, 312
Aluminium wall cover, closed, 70170, 312
Aluminium wall cover, closed, 70210, 312
Aluminium wall cover, closed, 90110, 311
Aluminium wall cover, closed, 90130, 312
Aluminium wall cover, closed, 90170, 312
Aluminium wall cover, closed, 90210, 312
Aluminium wall cover, open, 70110, 310
Aluminium wall cover, open, 70130, 310
Aluminium wall cover, open, 70170, 311
Aluminium wall cover, open, 70210, 311
Aluminium wall cover, open, 90110, 310
Aluminium wall cover, open, 90130, 310
Aluminium wall cover, open, 90170, 311
Aluminium wall cover, open, 90210, 311
Antenna socket 1/1 module width, 347
Antenna socket SAT 1/2 module width, 347
Aura range cover frame, 355
Aura range cover frame, rectangular, 355

B

Bend radius, external corner, 189, 192, 195, 202, 205
Bend radius, flat angle, 188, 192, 194, 201, 204
Bend radius, internal corner, 189, 192, 195, 201, 204
Blanking cover 1/1 module width, 348
Blanking cover 1/2 module width, 348

C

Cable bracket, 143, 155
Cable outlet, 1/1 module width, 348
CEE 16 A accessory mounting box, 356
CEE 32 A accessory mounting box, 357
CEE accessory mounting box, 124
CEE adapter flange 16 A, 125
CEE adapter flange 32 A, 125
Ceiling panel, 322
Ceiling panel for ISO70140, 320
Ceiling panel for ISS 120, 318
Ceiling panel for ISS 140110, 324
Ceiling panel for ISS 140220, 325
Ceiling panel for ISS110100F, 328
Ceiling panel for ISS110100R, 327
Ceiling panel for ISS140100F, 330
Ceiling panel for ISS140100R, 329
Ceiling panel for ISS90110, 323
Ceiling panel for ISSRM45, 326
Ceiling panel for ISSRM45F, 327
Ceiling panel for ISST70140, 320
Ceiling panel for ISST70140B, 322
Central plate for Aura range, rectangular standard, 355 penetration
Changeover switch 1/1 module width, 344-345
Changeover switch 1/2 module width, 344-345
Clamp, 305

C

Clamp fastening, 317
Classic stand for floor plate, 331
Connection adapter, 344
Connection adapter, straight, connector part, 343
Connection adapter, straight, socket part, 344
Connection adapter, U-shaped, connector part, 344
Connection profile for trunking height 170 mm, 304
Connection profile for trunking height 210 mm, 304
Connection protection, 350
Convection grid profile, 307
Convectector panelling, 307
Coupling, 208, 211, 214, 266, 269, 272, 275, 278, 281, 284, 287, 290, 293, 296, 299
Coupling pins, 307
Coupling, trunking depth 70 mm, 220, 225, 230, 236, 241, 247, 252, 258
Coupling, trunking depth 90 mm, 220, 225, 230, 236, 241, 247, 252, 258
Cover, 126, 164-181, 188, 191, 194, 200, 203
Cover clip, 126, 188, 191
Cover clip for 110 mm trunking width, 121
Cover clip for 130 mm trunking width, 121
Cover clip for 150 mm trunking width, 121
Cover clip for 170 mm trunking width, 121
Cover clip for 210 mm trunking width, 121
Cover clip for 230 mm trunking width, 122
Cover clip for 60 mm trunking width, 121
Cover clip for 90 mm trunking width, 121
Cover for CEE accessory mounting box, 125
Cover for double accessory mounting box, trunking, 123 height 110 mm
Cover for double accessory mounting box, trunking, 123 height 130 mm
Cover for double accessory mounting box, trunking, 123 height 150 mm
Cover for double accessory mounting box, trunking, 124 height 170 mm
Cover for double accessory mounting box, trunking, 124 height 210 mm
Cover for single accessory mounting box, trunking, 122 height 110 mm
Cover for single accessory mounting box, trunking, 123 height 130 mm
Cover for single accessory mounting box, trunking, 123 height 150 mm
Cover for single accessory mounting box, trunking, 124 height 170 mm
Cover for triple accessory mounting box, trunking height, 123 110 mm
Cover for triple accessory mounting box, trunking height, 123 130 mm
Cover for triple accessory mounting box, trunking height, 124 150 mm
Cover for triple accessory mounting box, trunking height, 124 170 mm
Cover frame S990, double, 353
Cover frame S990, single, 353
Cover frame S990, triple, 354
Cover screen, 316
CP cross connect, connector – socket version, 351
Cross switch 1/1 module width, 345

D

Danish standard socket 0°, 342
Data connection module with support plate, Cat. 5e, 348 shielded
Data connection module with support plate, Cat. 5e, 348 shielded
Data connection module with support plate, Cat. 6, 348
Data connection module with support plate, Cat. 6, 349 shielded for 10GbE
Data technology support 1/1 module width, 349
Data technology support 1/2 module width, 349
Data technology support Typ A, 1/1 module width, 351
Data technology support Typ B, 1/1 module width, 352

D

Data technology support Typ C, 1/1 module width, 352
 Data technology support Typ EP, 1/1 module width, 352-353
 Data technology support Typ F, 1/1 module width, 353
 Data technology support Typ PA, 1/1 module width, 353
 Device installation trunking, trunking depth 70 mm, 220, 225, 230, 236, 241, 247, 252, 258
 Device installation trunking, trunking depth 90 mm, 220, 225, 230, 236, 241, 247, 252, 258
 Device installation trunking, type GK70110, 208
 Device installation trunking, type GK70130, 211
 Device installation trunking, type GK70170, 214
 Device support, 159, 161
 Double accessory mounting box, 208, 211, 214, 220, 225, 230, 236, 241, 247, 252, 258, 266, 269, 272, 275, 278, 281, 284, 287, 290, 293, 296, 299, 331, 335
 Double/triple accessory mounting box Modul 45, 338
 Duct clamp, 155, 210, 213, 216, 224, 229, 234, 240, 245, 251, 256, 262
 Duct clamp for function maintenance E30–E90, 148

E

Earthing cable, 200, 203
 Earthing terminal, 200, 203
 Edge protection ring, 138-140, 142, 144, 146, 148, 150, 152, 154
 Encoding pin, 342
 End piece, 87, 89-90, 92, 94-96, 98-99, 101-114, 116-120, 126, 128-134, 141, 144-145, 147, 149, 151, 153, 195, 210, 213, 216, 268, 271, 274, 277, 280, 283, 286, 289, 292, 295, 298, 301
 End piece left, 158, 160, 190, 193, 202, 205
 End piece right, 158, 160, 190, 193, 202, 205
 End piece, trunking depth 70 mm, 224, 229, 234, 240, 245, 250, 256, 262
 End piece, trunking depth 90 mm, 224, 229, 234, 240, 245, 251, 256, 262
 Equipotential bonding socket 1/1 module width, 348
 External corner, 141, 143, 145, 147, 149, 151, 153, 189, 192, 195, 202, 205, 209, 212, 215, 267, 270, 273, 276, 279, 282, 285, 288, 291, 294, 297, 300
 External corner cover, fluted, 209, 212, 215
 External corner cover, smooth, 209, 212, 215
 External corner hood, 86, 88, 91, 93, 95, 97, 99-100, 102-115, 117-120, 129-134, 158, 160, 189, 192, 195, 201, 204
 External corner, trunking depth, 70 mm, 222, 227, 232, 238, 243, 248, 254, 260
 External corner, trunking depth, 90 mm, 222, 227, 232, 238, 243, 249, 254, 260

F

Falling flat angle, 188, 191, 201, 204, 267, 270, 273, 276, 279, 282, 285, 288, 291, 294, 297, 300
 Falling flat angle, trunking depth 70 mm, 233, 244, 249, 255, 261
 Falling flat angle, trunking depth 90 mm, 233, 244, 249, 255, 261
 Fastening bracket for ISST70140, 319
 Fastening bracket for ISST70140B, 321
 Fastening panels, 304
 Fibre optic coupling with support plate, 349
 Flat angle, 141, 143, 145, 147, 149, 151, 153, 194, 209, 212, 215
 Flat angle cover, fluted, 210, 213, 216
 Flat angle cover, smooth, 209, 212, 215
 Flat angle hood, 86, 88, 91, 93, 95, 97, 99-100, 102-115, 117-120, 129-134
 Flat angle, trunking depth 70 mm, 222, 227, 238
 Flat angle, trunking depth 90 mm, 222, 227, 238
 Floor panel, 306-307
 Floor plate for ISS110100F, 328
 Floor plate for ISS140100F, 330
 Floor plate for ISS140110, 324
 Floor plate for ISS70110, 322
 Floor plate for ISS90110, 323
 Floor plate for ISSO70140, 320

F

Floor plate for ISSRM45F, 326
 Floor plate for ISST70140, 319
 Floor plate for ISST70140B, 321
 Floor trunking, type 2650, 161
 Front cover, 126

G

GEK-A device installation trunking, type 100213, 299
 GEK-A device installation trunking, type 70110, 266
 GEK-A device installation trunking, type 70133, 272
 GEK-A device installation trunking, type 70213, 296
 GEK-A device installation trunking, type 90110, 269
 GEK-A device installation trunking, type 90133, 275
 GEK-AA device installation trunking, type 70173, 278
 GEK-AA device installation trunking, type 70173D, 290
 GEK-AA device installation trunking, type 70213, 284
 GEK-AA device installation trunking, type 90173, 281
 GEK-AA device installation trunking, type 90173D, 293
 GEK-AA device installation trunking, type 90213, 287

H

Hat profile rail, perforated, 185
 Hat profile rail, unperforated, 185
 Hinge dust protection, 350
 Hole punch, 196
 Hose connection for ISS110100F, 328
 Hose connection for ISS140100F, 330
 Hose connection for ISSRM45F, 326

I

Installation unit, 357
 Internal corner, 141, 143, 145, 147, 149, 151, 153, 189, 192, 195, 201, 204, 210, 213, 216, 267, 270, 273, 276, 279, 282, 285, 288, 292, 295, 297, 300
 Internal corner hood, 86, 88, 91, 93, 95, 97, 99-100, 102-115, 117-120, 129-134, 158, 160, 189, 192, 194, 201, 204
 Internal corner, simplified, trunking depth 70 mm, 244, 250, 255, 261
 Internal corner, simplified, trunking depth 90 mm, 244, 250, 255, 261
 Internal corner, trunking depth 70 mm, 223, 228, 233, 239
 Internal corner, trunking depth 90 mm, 223, 228, 233, 239
 Intersection, 190, 193, 202, 205

J

Joint connector, 138-141, 143, 145, 147, 149, 151, 153, 200, 203
 Joint cover, 86, 88, 91, 93, 97, 100, 158, 160, 188, 191, 194, 200, 203
 Joint cover, trunking depth 70 mm, 221, 226, 231, 237, 242, 248, 253, 259
 Joint cover, trunking depth 90 mm, 221, 226, 231, 237, 242, 248, 253, 259

K

Key for connection protection, 350
 Knock-in anchor, 125

L

LK4 wiring trunking, type LK4 60060, 166
 Locking bracket, 221, 226, 231, 237, 242, 248, 253, 259

M

Mechanical and visual insertion protection, 350
 Mini trunking with adhesive film and hinge cover MD12, 84
 Mini trunking with adhesive film and hinge cover MD17, 84
 Mini trunking with adhesive film and hinge cover MD4, 84
 Mini trunking with adhesive film and hinge cover MD7, 84
 Mini trunking with adhesive film M11, 84
 Mini trunking with adhesive film M7, 84
 Mini trunking with adhesive film M9, 84
 Modul 45connect socket with earthing pin 33°, triple, 343
 Modul 45connect socket with earthing pin 33°, double, 343
 Modul 45connect sockets, 33°, double, 343

Alphabetical table of contents

M

- Modul 45connect sockets, 33°, triple, 343
- Mounting and connection profile for convection grids,, 305
trunking depth 70 mm
- Mounting and connection profile for convection grids,, 305
trunking depth 90 mm
- Mounting and connection profile for convector panelling,, 306
trunking depth 70 mm
- Mounting and connection profile for convector panelling,, 306
trunking depth 90 mm
- Mounting support for data technology and Modul 45, 338
connect

N

- Noise limit barrier, 313
- Noise protection, sold by the metre, 313

O

- One-way switch, 1/1 module width, 345
- One-way switch, 1/2 module width, 344

P

- Partition, 155, 188, 191, 194, 200, 203
- Partition for ISS 120, 318
- Partition for trunking height 100 mm, 122
- Partition for trunking height 40 mm, 122
- Partition for trunking height 60 mm, 122
- Partition for trunking height 80 mm, 122
- Plastic external corner cover, fluted, 222, 227, 232, 238, 243, 254,
260
- Plastic external corner cover, smooth, 222, 227, 232, 238, 243, 254,
260
- Plastic flat angle cover, fluted, 223, 228, 233, 239, 244, 255, 261
- Plastic flat angle cover, smooth, 223, 228, 233, 239, 244, 255, 261
- Plastic rivet tool, 184
- Plastic trunking cover, fluted, 221, 226, 231, 237, 242, 253, 259
- Plastic trunking cover, smooth, 221, 226, 231, 237, 242, 253, 259
- Plug-in protector for RJ45, 350
- Profile connector, horizontal, 305
- Profile connector, vertical, 306
- Protective conductor connection bracket, 224, 229, 235, 240, 246,
251, 257, 263
- Protective contact socket 0°, 338-339
- Protective contact socket 33°, 339
- Protective frame for ISSHS4, 332
- PVC wall cover, closed, 70110, 309
- PVC wall cover, closed, 70130, 309
- PVC wall cover, closed, 70170, 309
- PVC wall cover, closed, 70210, 310
- PVC wall cover, closed, 90110, 309
- PVC wall cover, closed, 90130, 309
- PVC wall cover, closed, 90170, 309
- PVC wall cover, closed, 90210, 310
- PVC wall cover, open, 70110, 307
- PVC wall cover, open, 70130, 308
- PVC wall cover, open, 70170, 308
- PVC wall cover, open, 70210, 308
- PVC wall cover, open, 90110, 307
- PVC wall cover, open, 90130, 308
- PVC wall cover, open, 90170, 308
- PVC wall cover, open, 90210, 308

R

- Rapid 45 device installation trunking, type GEK-A, 200
53100
- Rapid 45 device installation trunking, type GEK-A, 203
53160
- Rapid 45 device installation trunking, type GEK-K, 188
53100
- Rapid 45 device installation trunking, type GEK-K, 191
53160
- Rapid 45 device installation trunking, type GEK-K, 194
53160-3
- Reassignment tool, 331

R

- Reducing frame, RJ45 to RJ11/RJ12, 349
- Release pliers, 184
- Rising flat angle, 188, 191, 201, 204, 267, 270, 273, 276, 279, 282,
285, 288, 291, 294, 297, 300
- Rising flat angle, trunking depth 70 mm, 232, 243, 249, 254, 260
- Rising flat angle, trunking depth 90 mm, 232, 243, 249, 254, 260
- Roller blind button 1/1 module width, 345
- Roller blind switch, 1/1 module width, 345
- Rubber support for ISS 140110, 324
- Rubber support for ISS70110, 322
- Rubber support for ISS90110, 323
- Rubber support for ISSO70140, 320
- Rubber support for ISSRM45, 326
- Rubber support for ISST70140, 319
- Rubber support for ISST70140B, 321

S

- S990 cover frame with labelling panel, double, 354
- S990 cover frame with labelling panel, double,, 354
rectangular
- S990 cover frame with labelling panel, single, 354
- S990 cover frame with labelling panel, single,, 354
rectangular
- S990 cover frame with labelling panel, triple, 354
- S990 cover frame with labelling panel, triple,, 354
rectangular
- Safe clip, 350
- Screen profile for ISS 120, 318
- Separating retainer, 210, 213, 216
- Series switch, 1/1 module width, 345
- Service pole, sheet steel, with PVC cover, 316
- Service pole, sheet steel, with sheet steel cover, 316
- Service pole, type ISS110100F, 328
- Service pole, type ISS110100R, 327
- Service pole, type ISS120, 318
- Service pole, type ISS140100F, 329
- Service pole, type ISS140100R, 329
- Service pole, type ISS140110, 324
- Service pole, type ISS140220, 325
- Service pole, type ISS70110, 322
- Service pole, type ISS90110, 323
- Service pole, type ISSHS140250, 333
- Service pole, type ISSHS140500, 333
- Service pole, type ISSHS140700, 333
- Service pole, type ISSHS2D120, 334
- Service pole, type ISSHS4, 332
- Service pole, type ISSHS6, 334
- Service pole, type ISSHSO270140, 333
- Service pole, type ISSHSO70140, 333
- Service pole, type ISSO70140, 320
- Service pole, type ISSRHSM45, 334
- Service pole, type ISSRM45, 325
- Service pole, type ISSRM45F, 326
- Service pole, type ISST70140, 319
- Service pole, type ISST70140B, 321
- Shears for WDK trunking, mitre cut, 85
- Shears for WDK trunking, straight cut, 85
- Sheet steel external corner cover, 222, 227, 232, 238, 243, 254, 260
- Sheet steel external corner cover, size 50 track, 249
- Sheet steel external corner cover, size 80 track, 249
- Sheet steel flat angle cover, 223, 228, 233, 239, 244, 255, 261
- Sheet steel flat angle cover, size 50 track, 250
- Sheet steel flat angle cover, size 80 track, 250
- Sheet steel partition, trunking depth 70 mm, 224, 229, 234, 240, 245,
251, 256, 262
- Sheet steel partition, trunking depth 90 mm, 224, 229, 234, 240, 245,
251, 256, 262
- Sheet steel trunking cover, size 50 track, 248
- Sheet steel trunking cover, size 80 track, 248
- Single accessory mounting box, 208, 211, 214, 220, 225, 230, 236,
241, 247, 252, 258, 266, 269, 272,
275, 278, 281, 284, 287, 290, 293,

S

Single accessory mounting box, 296, 299, 331, 335
 Single accessory mounting box Modul 45, 331, 335, 338
 SKL skirting trunking, type SKL 50 D, 158
 SKL skirting trunking, type SKL 70 D, 160
 Socket unit with labelling panel, double, 356
 Socket unit with labelling panel, single, 356
 Socket unit with labelling panel, triple, 356
 Socket unit, double, 355
 Socket unit, single, 355
 Socket unit, triple, 356
 Socket with earthing pin 0°, 339-340
 Socket with earthing pin 0° – encoded version, 341
 Socket with earthing pin 33°, 340
 Socket with earthing pin 33° – encoded version, 341-342
 Spacer, 185
 Spacer for floor plate, 331
 Spreading rivet, KSN 1, 184
 Spreading rivet, KSN 2, 184
 Strain relief, 208, 211, 214, 221, 226, 231, 237, 242, 248, 253, 259, 266, 269, 272, 275, 278, 281, 284, 287, 290, 293, 296, 299, 338, 342, 344
 Supply trunking, 313
 Support rail, perforated, 185
 Support rail, unperforated, 185
 Surge protection 1/2 module width, acoustic signalling, 346
 Surge protection 1/2 module width, visual signalling, 346
 Surge protection module, acoustic signalling, 346
 Swiss standard socket 0°, 342

T

T and intersection hood, 104-115, 117-120, 129-134
 T piece, 141, 143, 145, 147, 149, 151, 153, 195, 210, 213, 216, 267, 270, 273, 276, 279, 282, 285, 288, 292, 295, 297, 300
 T piece hood, 86, 88, 92, 94-95, 97, 99, 101-103
 T piece, falling, 190, 193, 202, 205
 T piece, rising, 189, 193, 202, 205
 T piece, trunking depth 70 mm, 223, 228, 234, 239, 245, 250, 256, 262
 T piece, trunking depth 90 mm, 223, 228, 234, 239, 245, 250, 256, 262
 Telephone connection box 1/1 module width, 347
 Triple accessory mounting box Modul 45, 331, 335
 Trunking cover, fluted, 209, 212, 215
 Trunking cover, sheet steel, 221, 226, 231, 237, 242, 253, 259
 Trunking cover, smooth, 208, 211, 214
 Trunking, type LKM 20020, 138
 Trunking, type LKM 20030, 139
 Trunking, type LKM 30030, 140
 Trunking, type LKM 40040, 141
 Trunking, type LKM 40060, 143
 Trunking, type LKM 60060, 145
 Trunking, type LKM 60100, 147
 Trunking, type LKM 60150, 149
 Trunking, type LKM 60200, 151
 Trunking, type LKM 80080, 153
 Trunking, type WDK 100130, 118
 Trunking, type WDK 10020, 86
 Trunking, type WDK 100230, 120
 Trunking, type WDK 10030, 88
 Trunking, type WDK 15015, 90
 Trunking, type WDK 15030, 91
 Trunking, type WDK 15040, 93
 Trunking, type WDK 20020, 95
 Trunking, type WDK 20035, 96
 Trunking, type WDK 20050, 97
 Trunking, type WDK 25025, 99
 Trunking, type WDK 25040, 100
 Trunking, type WDK 30030, 102
 Trunking, type WDK 30045, 103
 Trunking, type WDK 40040, 104
 Trunking, type WDK 40060, 105

T

Trunking, type WDK 40090, 106
 Trunking, type WDK 40110, 107
 Trunking, type WDK 60060, 108
 Trunking, type WDK 60090, 109
 Trunking, type WDK 60110, 111
 Trunking, type WDK 60130, 112
 Trunking, type WDK 60150, 113
 Trunking, type WDK 60170, 114
 Trunking, type WDK 60210, 115
 Trunking, type WDK 60230, 110
 Trunking, type WDK 80170, 119
 Trunking, type WDK 80210, 117
 Trunking, type WDK-H 20020, 128
 Trunking, type WDK-H 30045, 129
 Trunking, type WDK-H 40060, 130
 Trunking, type WDK-H 40061, 131
 Trunking, type WDK-H 60090, 132
 Trunking, type WDK-H 60110, 133
 Trunking, type WDK-H 60150, 134
 Trunking, type WDK-N 10020, 86
 Trunking, type WDK-N 10030, 88
 Trunking, type WDK-N 15030, 91
 Trunking, type WDK-N 15040, 93
 Trunking, type WDK-N 20050, 97
 Trunking, type WDK-N 25040, 100

U

Universal cable, connector – connector version, 351

W

Wall panel adapter for GK, trunking height 110 mm, 304
 Wall panel adapter for GK, trunking height 130 mm, 304
 Wall panel adapter for GK, trunking height 170 mm, 304
 Washer, 185
 Wire retainer for type LK4 and LK4/N, 184
 Wire retainer for type LKV and LKV/N, 184
 Wire retainer for type LKV/H, 184
 Wiring trunking, type 100100, 178, 181
 Wiring trunking, type 10037, 177, 180
 Wiring trunking, type 10050, 177, 180
 Wiring trunking, type 10075, 177, 181
 Wiring trunking, type 25025, 174
 Wiring trunking, type 37025, 174
 Wiring trunking, type 37037, 174
 Wiring trunking, type 50025, 174
 Wiring trunking, type 50037, 175, 182
 Wiring trunking, type 50050, 175, 182
 Wiring trunking, type 50075, 175, 182
 Wiring trunking, type 75025, 175, 179
 Wiring trunking, type 75037, 176, 179, 182
 Wiring trunking, type 75050, 176, 179, 182
 Wiring trunking, type 75075, 176, 179, 182
 Wiring trunking, type 75100, 176, 180, 182
 Wiring trunking, type 75125, 177, 180, 183
 Wiring trunking, type LK4 15015, 164
 Wiring trunking, type LK4 30015, 164
 Wiring trunking, type LK4 30025, 164
 Wiring trunking, type LK4 40025, 164
 Wiring trunking, type LK4 40040, 165
 Wiring trunking, type LK4 40060, 165
 Wiring trunking, type LK4 40080, 165
 Wiring trunking, type LK4 40100, 165
 Wiring trunking, type LK4 60015, 166
 Wiring trunking, type LK4 60025, 166
 Wiring trunking, type LK4 60040, 166
 Wiring trunking, type LK4 60080, 167
 Wiring trunking, type LK4 60100, 167
 Wiring trunking, type LK4 60120, 167
 Wiring trunking, type LK4 80025, 167
 Wiring trunking, type LK4 80040, 168

Alphabetical table of contents

W

Wiring trunking, type LK4 80060,	168
Wiring trunking, type LK4 80080,	168
Wiring trunking, type LK4 80100,	168
Wiring trunking, type LK4 80120,	169
Wiring trunking, type LK4/N 60015,	170
Wiring trunking, type LK4/N 60025,	170
Wiring trunking, type LK4/N 60040,	170
Wiring trunking, type LK4/N 60060,	170
Wiring trunking, type LK4/N 60080,	171
Wiring trunking, type LK4/N 60100,	171
Wiring trunking, type LK4/N 60120,	171
Wiring trunking, type LK4/N 80025,	171
Wiring trunking, type LK4/N 80040,	172
Wiring trunking, type LK4/N 80060,	172
Wiring trunking, type LK4/N 80080,	172
Wiring trunking, type LK4/N 80100,	172
Wiring trunking, type LK4/N 80120,	173

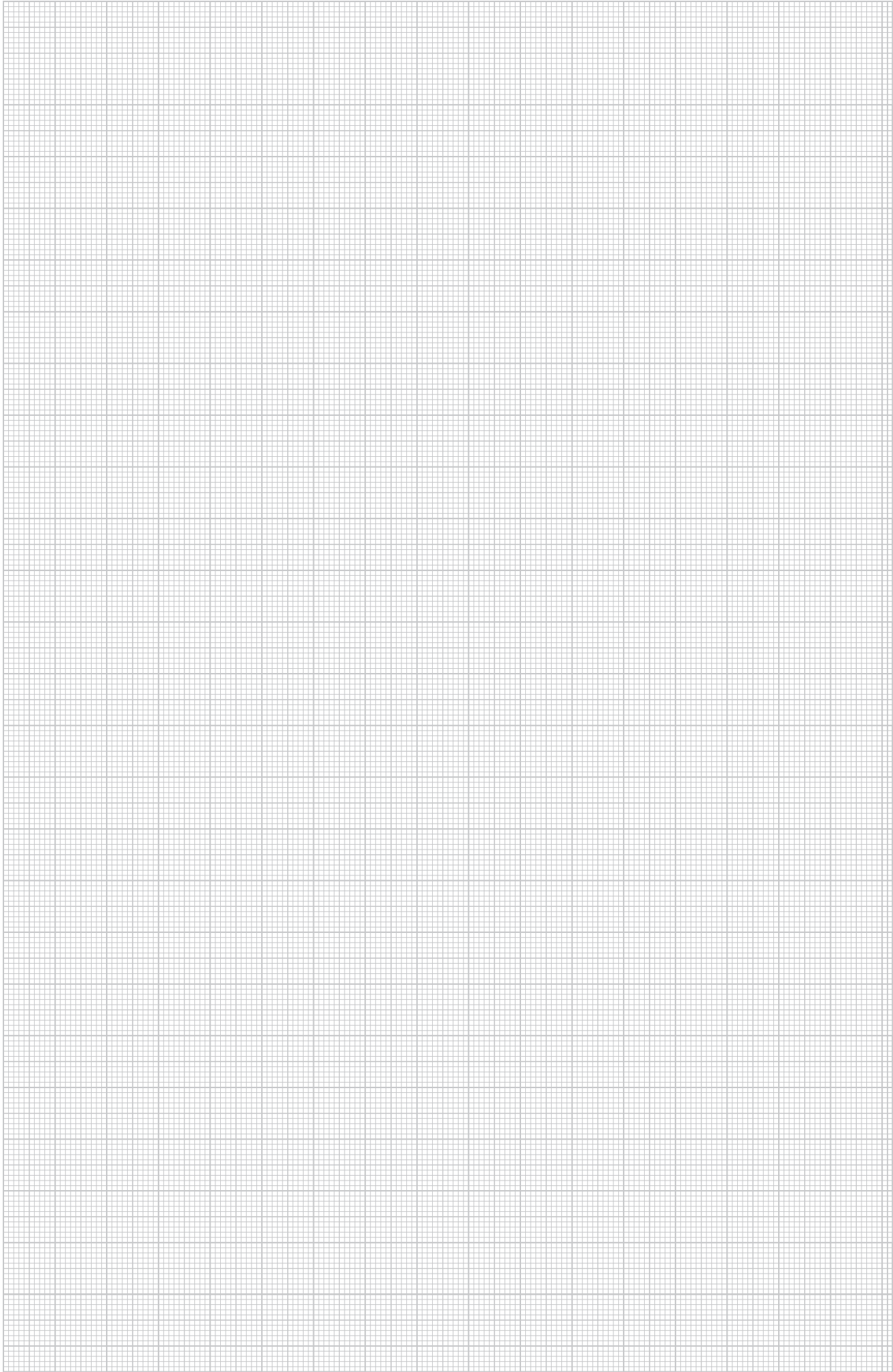

Numeric directory

Structure of the EAN number: Country code **40**

Manufacturer code **1219** (for articles beginning with **0: 1010**)

Individual EAN-C **5647589**

EAN-C.	Art. no.	Price	Page	EAN-C.	Art. no.	Price	Page	EAN-C.	Art. no.	Price	Page	EAN-C.	Art. no.	Price	Page
5044291	1115 05 7	/100 m	185	6023417	6022 75 8	/m	126	6029112	6025 63 3	/m	105	5364566	6106 72 5	/pc.	342
5044352	1115 06 5		185					6029174	6025 66 8		108	5364597	6106 72 7		342
5045434	1115 65 0		185	6023776	6022 99 5		121					5364603	6106 72 9		342
5045496	1115 66 9		185					6029778	6026 17 6		119	5364610	6106 73 5		342
								6029839	6026 18 4		119				
								6029891	6026 19 2		117				
5669197	2351 05 6	/100 pc.	125	6023837	6023 00 2	/pc.	109	6029952	6026 20 6		117	5120957	6107 00 2		353
				6023950	6023 02 9		111	6030132	6026 27 3		118				
				6024070	6023 04 5		112	6030194	6026 28 1		118	5405726	6107 00 8		353
				6024193	6023 06 1		114	6642076	6026 31 1		120				
				6192618	6023 08 1		189	6642137	6026 33 8		120	5121022	6107 05 2		354
5080886	5092 45 1	/pc.	346	6192670	6023 08 5		189	6667451	6026 35 4		96				
				6192731	6023 08 9		188	6642793	6026 36 2		96	5405733	6107 05 8		354
								6642854	6026 37 0		96				
								6667512	6026 40 0		99	5273240	6107 07 2		354
6362530	6020 80 1	/m	161	6024315	6023 09 6	/m	122	6030255	6026 41 9		99	5273288	6107 07 8		354
				6024377	6023 11 8	/pc.	122	6030316	6026 42 7		99	5121084	6107 10 2		353
								6030439	6026 44 3		100				
6016273	6020 88 7		105	6024438	6023 12 6		115	6030491	6026 45 1		100	5405740	6107 10 8		353
6016334	6020 89 5		106	6024551	6023 14 2		106	6667574	6026 79 6		102				
6016396	6020 90 9		107	6024919	6023 20 7		122	6332953	6026 81 8		102	5121183	6107 15 2		354
				6025039	6023 22 3		108	6333011	6026 82 6		102				
6016877	6021 01 8		106	6025459	6023 31 2		105	6667635	6026 84 2		103	5405757	6107 15 8		354
6016990	6021 03 4		107	6025572	6023 33 9	/100 pc.	107	6640874	6026 85 0		103				
								6640935	6026 86 9		103	5273349	6107 17 2		354
6017171	6021 09 3		106	6026111	6023 50 9		121	6030675	6026 98 2		122	5273356	6107 17 8		354
6017652	6021 19 0		106	6026173	6023 51 7		121	6030736	6026 99 0		122	5121244	6107 20 2		354
6018253	6021 33 6		106	6026234	6023 52 5		121								
6018857	6021 49 2		105	6637874	6023 53 3		121	6667697	6027 01 6		104	5405764	6107 20 8		354
6018918	6021 50 6		106	6026296	6023 54 1		121	6667758	6027 02 4		105				
6018970	6021 51 4		107	6026357	6023 57 6		121	6667819	6027 03 2		106	5121305	6107 25 2		354
6019212	6021 69 7		105	6639250	6023 58 4		122	6667871	6027 04 0		107				
6019274	6021 70 0		107					6667994	6027 10 5		108	5405771	6107 25 8		354
6019335	6021 71 9		105					6668052	6027 11 3		109				
6019397	6021 72 7		107	6027132	6024 00 9		124	6668113	6027 12 1		111	5273417	6107 27 2		354
6019458	6021 73 5		105	6027255	6024 02 5		125	6668175	6027 14 8		112	5273424	6107 27 8		354
6019519	6021 74 3		107	6027316	6024 03 3		125	6668236	6027 15 6		113	5273462	6107 37 2		355
				6638116	6024 43 2		113	6668298	6027 16 4		114	5273479	6107 37 8		355
6019816	6021 84 0	/m	111	6639496	6024 44 0		110	6668359	6027 17 2		115				
6019878	6021 85 9		112	6027491	6024 46 7		119	6668410	6027 18 0		110				
6019939	6021 86 7		114	6027552	6024 47 5		117	6668472	6027 22 9		119	6292578	6116 02 7	/m	188
6019991	6021 87 5		115	6027613	6024 48 3		118	6668533	6027 23 7		117	6292516	6116 05 1		191
6637577	6021 88 3		113	6502097	6024 50 5		120	6668595	6027 24 5		118	5391630	6116 07 3		194
6638956	6021 89 1		110	6638291	6024 52 1		113	6668656	6027 25 3		119	6708970	6116 10 8		188
6020119	6021 91 3		109	6639670	6024 54 8		110								
6020171	6021 94 8		108	6027675	6024 56 4		119	6669257	6028 15 2		126	6176236	6116 11 6	/pc.	188
				6027736	6024 57 2		117	6773893	6028 18 7		126	6441259	6116 15 0		188
6020232	6022 00 6		109	6027798	6024 58 0		118					6183739	6116 15 4		200
6020294	6022 01 4		111	6638475	6024 59 9		113	6628216	6028 40 3	/pc.	85	5391647	6116 16 3		194
6020355	6022 02 2		112	6639854	6024 60 2		110	6628278	6028 41 1		85	5391913	6116 16 7		189
6637515	6022 03 0		113	6027859	6024 61 0		119					5391920	6116 16 9		202
6020416	6022 04 9		114	6027910	6024 62 9		117					5391968	6116 17 2		193
6638895	6022 05 7		110	6027972	6024 63 7		118	5364139	6106 67 1		341	5391975	6116 17 4		205
6020478	6022 06 5		115	6501311	6024 65 3		120	5364146	6106 67 3		341	5391982	6116 18 0		190
				6501915	6024 68 8		120	5364177	6106 67 5		341	5392026	6116 18 1		202
6020539	6022 07 3	/pc.	108	6501670	6024 71 8		120	5364184	6106 67 7		341	5392033	6116 18 4		193
6020713	6022 11 1		109	6638659	6024 76 9		113	5364191	6106 67 9		341	5392040	6116 18 5		205
6020836	6022 14 6		111	6640034	6024 77 7		110	5364207	6106 68 1		341	5391654	6116 19 3		195
6020959	6022 16 2		112	6028030	6024 79 3		119	5364238	6106 68 3		341	5428688	6116 20 1		194
6021079	6022 18 9		114	6028092	6024 80 7		117	5364245	6106 68 5		341	5391661	6116 20 3		195
6021130	6022 19 7		115	6028153	6024 81 5		118	5364252	6106 68 7		341	6709038	6116 20 5		189
6021253	6022 21 9		109	6637935	6024 82 3		113	5364269	6106 68 9		341	6183678	6116 21 0		201
6021376	6022 23 5		111	6639311	6024 83 1		110	5364306	6106 69 1		341	6192793	6116 21 3		189
6021499	6022 25 1		112	6028214	6024 85 8		119	5364313	6106 69 3		341	6440955	6116 22 1		192
6021611	6022 28 6		114	6028276	6024 87 4		117	5364320	6106 69 5		341	6184699	6116 22 6		204
6021673	6022 29 4		115	6028337	6024 88 2		118	5364368	6106 69 7		341	6192977	6116 24 8		192
6021796	6022 31 6		109	6651375	6024 90 4		120	5364375	6106 69 9		341	5428695	6116 26 1		195
6021918	6022 33 2		111					5364382	6106 70 1		341	5391678	6116 26 3		195
6022038	6022 35 9		112	6667338	6024 94 7	/m	90	5364412	6106 70 3		341	6441013	6116 26 4		189
6022151	6022 37 5		114	6642250	6024 95 5		90</								

Numeric directory

Structure of the EAN number: Country code **40**

Manufacturer code **1219** (for articles beginning with **0: 1010**)

Individual EAN-C **5647589**

EAN-C.	Art. no.	Price	Page	EAN-C.	Art. no.	Price	Page	EAN-C.	Art. no.	Price	Page	EAN-C.	Art. no.	Price	Page
		/pc.				/pc.				/pc.				/pc.	
5670971	6119 87 4		343	6491537	6154 42 5		88	6106752	6160 52 2		118	6583935	6162 54 1		101
5670988	6119 87 6		343	6493210	6154 46 8		97	6502035	6160 54 9		120	6584239	6162 57 6		102
5670995	6119 87 8		343	6491834	6154 51 4		87	6579013	6160 60 3		95	6641239	6162 58 4		103
5671008	6119 88 0		343	6491353	6154 52 2		89	6579198	6160 61 1		91	6583331	6162 59 2		104
5671015	6119 88 2		343	6493395	6154 55 7		98	6579372	6160 63 8		93	6109517	6162 60 6		105
5671022	6119 88 4		343					6579556	6160 64 6		99	6109579	6162 61 4		106
5671039	6119 88 6		343	6543199	6156 20 7		126	6579730	6160 65 4		100	6109630	6162 62 2		107
5671046	6119 88 8		343	6543137	6156 22 3		126	6580095	6160 67 0		102	6109876	6162 80 0		108
5671084	6119 89 0		343	6543076	6156 23 1		126	6641598	6160 68 9		103	6109937	6162 81 9		109
5701507	6119 99 7		348					6580279	6160 69 7		104	6109999	6162 82 7		111
				6577576	6158 22 6		95	6106813	6160 70 0		105	6110056	6162 83 5		112
5406532	6119 99 8		348	6577750	6158 23 4		91	6106875	6160 71 9		106	6110117	6162 84 3		114
5406549	6119 99 9		348	6577934	6158 24 2		93	6106936	6160 72 7		107	6110179	6162 85 1		116
				6578115	6158 25 0		99	6107179	6160 90 5		108	6637997	6162 87 8		113
				6578290	6158 26 9		100	6107230	6160 91 3		109	6639373	6162 88 6		110
		/m		6578658	6158 28 5		102	6107292	6160 92 1		111				
6798070	6150 07 1		84	6578832	6158 29 3		104	6107353	6160 94 8		112	6110230	6163 00 9		119
6798131	6150 09 8		84	6641352	6158 30 7		103	6107414	6160 95 6		114	6110292	6163 01 7		117
6798193	6150 10 1		84	6578955	6158 33 1		95	6107476	6160 96 4		115	6110353	6163 04 1		118
6097579	6150 15 2		84	6579136	6158 35 8		91	6638352	6160 97 2		113	6651436	6163 07 6		120
6097630	6150 16 0		84	6579310	6158 36 6		93	6639731	6160 98 0		110				
6097692	6150 17 9		84	6579495	6158 37 4		99					6782659	6168 52 3		125
6097753	6150 18 7		84	6579679	6158 38 2		100	6107537	6161 10 3		119			/m	
6493159	6150 26 8		84	6580033	6158 40 4		102	6107599	6161 11 1		117	6438433	6168 70 1		97
6493098	6150 27 6		84	6580217	6158 41 2		104	6107650	6161 15 4		118	6438495	6168 72 8		97
6493036	6150 28 4		84	6641536	6158 42 0		103	6501854	6161 17 0		120	6801671	6168 73 6		97
6492978	6150 29 2		84	6580392	6158 45 5		95	6581894	6161 20 0		95	6802159	6168 74 4		97
6097814	6150 40 3		86	6580576	6158 46 3		92	6582075	6161 21 9		91				
6492190	6150 41 1		86	6580750	6158 47 1		94	6582259	6161 22 7		93			/pc.	
6097876	6150 44 6		88	6580934	6158 49 8		99	6582433	6161 23 5		99	6781393	6169 29 5		123
6491711	6150 45 4		88	6581115	6158 50 1		101	6582617	6161 24 3		100	6111619	6169 30 9		122
6507979	6150 51 9		91	6581474	6158 53 6		102	6582976	6161 27 8		102	6111671	6169 31 7		123
6493456	6150 52 7		91	6581658	6158 54 4		104	6641772	6161 28 6		103	6111732	6169 32 5		124
6097999	6150 53 5		93	6641895	6158 55 2		103	6583157	6161 29 4		104	6782291	6169 36 8		123
6494477	6150 54 3		93	6581832	6158 58 7		95	6107711	6161 30 8		105	6111855	6169 37 6		123
6507191	6150 63 2		100	6582013	6158 59 5		91	6107773	6161 31 6		106	6111916	6169 38 4		123
6975686	6150 64 0		100	6582198	6158 60 9		93	6107834	6161 32 4		107	6111978	6169 39 2		124
6098170	6150 75 6		86	6582372	6158 61 7		99	6108077	6161 50 2		108	6112036	6169 40 6		124
6492251	6150 76 4		86	6582556	6158 62 5		100	6108138	6161 51 0		109	6782475	6169 42 2		124
6508037	6150 77 2		88	6582914	6158 64 1		102	6108190	6161 52 9		111	6112098	6169 43 0		123
6491773	6150 78 0		88	6583096	6158 66 8		104	6108251	6161 53 7		112	6112159	6169 44 9		123
		/pc.		6641710	6158 67 6		103	6108312	6161 54 5		114	6112210	6169 45 7		124
				6642618	6158 69 2		90	6108374	6161 55 3		115				
6098293	6152 00 7		86	6434473	6158 70 6		95	6638536	6161 56 1		113			/m	
6098354	6152 01 5		88	6434534	6158 71 4		92	6639915	6161 59 6		110	5237396	6175 00 2		128
6507610	6152 03 1		91	6434596	6158 72 2		94	6108435	6161 70 7		119	5237402	6175 00 8		129
6098477	6152 05 8		93	6434657	6158 73 0		99	6108497	6161 71 5		117	5237419	6175 01 4		130
6507375	6152 08 2		100	6434718	6158 74 9		101	6108558	6161 75 8		118	5237426	6175 02 0		131
6507252	6152 10 4		97	6584178	6158 76 5		102	6501250	6161 77 4		120	5237457	6175 02 6		132
6098712	6152 30 9		86	6583270	6158 77 3		104	6580453	6161 90 1		95	5237464	6175 03 2		133
6098774	6152 31 7		88	6643158	6158 78 1		96	6580637	6161 92 8		92	5237471	6175 03 8		134
6507795	6152 38 4		97	6434831	6158 80 3		103	6580811	6161 93 6		94			/pc.	
6099139	6152 60 0		86	6507559	6158 83 8		91	6580996	6161 94 4		99	5237488	6175 05 1		129
6099191	6152 61 9		88	6507498	6158 84 6		93	6581177	6161 95 2		101	5237495	6175 05 7		130
6507733	6152 68 6		97	6507436	6158 88 9		100	6581535	6161 97 9		102	5237501	6175 06 3		131
								6641956	6161 98 7		103	5237518	6175 06 9		132
6099559	6153 00 3		86	6103997	6159 37 0		123	6581719	6161 99 5		104	5237525	6175 07 5		133
6099610	6153 01 1		88									5237532	6175 08 1		134
6507917	6153 08 9		97	6577637	6160 01 8		95	6108619	6162 00 2		105	5237549	6175 10 3		129
6099979	6153 29 1		86	6577811	6160 02 6		91	6108671	6162 01 0		106	5237556	6175 10 9		130
6804498	6153 30 5		88	6577996	6160 03 4		93	6108732	6162 02 9		107	5237563	6175 11 5		131
6507856	6153 37 2		97	6578177	6160 04 2		99	6108978	6162 20 9		108	5237570	6175 12 1		132
6100392	6153 59 3		87	6578351	6160 05 0		100	6109036	6162 21 5		109	5237587	6175 12 7		133
6100453	6153 60 7		89	6578719	6160 07 7		102	6109098	6162 22 3		111	5237594	6175 13 3		134
6507672	6153 67 4		98	6641413	6160 08 5		103	6109159	6162 23 1		112	5237600	6175 15 0		128
				6584598	6160 09 3		104	6109210	6162 25 8		114	5237631	6175 15 6		129
6492138	6154 02 6		86	6105915	6160 10 7		105	6109272	6162 26 6		115	5237648	6175 16 2		130
6491650	6154 03 4		88	6105977	6160 11 5		106	6638710	6162 27 4		113	5237655	6175 16 8		131
6974481	6154 06 9		97	6106035	6160 12 3		107	6640096	6162 29 0		110	5237662	6175 17 4		132
6491957	6154 11 5		86	6106271	6160 30 1		108	6109333	6162 40 1		119	5237693	6175 18 0		133
6491476	6154 12 3		88	6106332	6160 32 8		109	6109395	6162 42 8		117	5237709	6175 18 6		134
6493272	6154 16 6		97	6106394											

EAN-C.	Art. no.	Price	Page	EAN-C.	Art. no.	Price	Page	EAN-C.	Art. no.	Price	Page	EAN-C.	Art. no.	Price	Page
		/pc.				/m				/pc.				/m	
5237822	6175 26 7		131	6040803	6178 49 0		165	6673278	6182 94 1		107	5042273	6191 30 4		119
5237839	6175 27 3		132	6040926	6178 49 2		167					5042280	6191 31 2		117
5237846	6175 27 9		133	6041282	6178 50 4		174	6677054	6183 01 8		108	5042297	6191 34 7		118
5237877	6175 28 5		134	6041404	6178 50 6		174	6677115	6183 02 6		109	5042303	6191 35 5		120
		/m												/pc.	
				6041527	6178 50 8		175	6677177	6183 03 4		111				
				6041640	6178 51 0		175	6677238	6183 04 2		112	6794652	6191 84 3		91
6000050	6178 00 1		164	6041763	6178 51 2		176	6677290	6183 05 0		113	6494651	6191 85 1		93
6000173	6178 00 3		164	6041886	6178 51 4		177	6677351	6183 06 9		114	6794713	6191 87 8		95
6000296	6178 00 5		164			/100 pc.		6677412	6183 07 7		115	6502219	6191 88 6		99
6000418	6178 01 0		164	6014279	6178 52 0		184	6677474	6183 08 5		110	6794775	6191 89 4		100
6000531	6178 01 2		165	6014392	6178 52 2		184	6677535	6183 12 3		119	6794836	6191 92 4		102
6000654	6178 01 4		165			/pc.		6677597	6183 13 1		117	6976829	6191 93 2		103
6000777	6178 01 6		165	6014514	6178 52 7		184	6677658	6183 16 6		118	6794898	6191 94 0		104
6000890	6178 01 8		165	6014637	6178 52 9		184	6501373	6183 18 2		120	6794959	6191 95 9		105
6001132	6178 02 6		166	6014750	6178 53 5		184	6673391	6183 21 2		95	6795017	6191 96 7		106
6001255	6178 02 8		166			/100 pc.		6673452	6183 25 5		99	6221110	6191 97 5		107
6001378	6178 03 1		166	6014873	6178 54 0		185	6673513	6183 29 8		102				
6001491	6178 03 3		166	6014996	6178 54 2		185	6673575	6183 30 1		103	6362950	6192 01 7		108
6001613	6178 03 5		167	6015061	6178 54 8		185	6673636	6183 33 6		104	6799879	6192 02 5		109
6001736	6178 03 7		167			/m		6673698	6183 34 4		105	6362776	6192 03 3		111
6001859	6178 03 9		167	6016266	6178 61 2		182	6673759	6183 35 2		106	6362479	6192 04 1		112
6002214	6178 05 0		167	6016389	6178 61 4		182	6673810	6183 36 0		107	6800056	6192 06 8		113
6002337	6178 05 2		168	6016501	6178 61 6		182	6677719	6183 40 9		108	6362233	6192 07 6		114
6002450	6178 05 4		168	6016747	6178 62 2		182	6677771	6183 41 7		109	6795079	6192 08 4		115
6002573	6178 05 6		168	6016860	6178 62 4		182	6677832	6183 42 5		111	6800896	6192 09 2		110
6002696	6178 05 9		168	6016983	6178 62 6		182	6677894	6183 43 3		112	5042457	6192 10 6		119
6002818	6178 06 1		169	6017102	6178 62 8		182	6677955	6183 44 1		113	5042525	6192 11 0		117
		/100 pc.		6017225	6178 63 0		183	6678013	6183 46 8		114	5042594	6192 11 4		118
6008339	6178 09 2		184			/100 pc.		6678075	6183 47 6		115	5042662	6192 11 8		120
		/m		6017829	6178 65 0		184	6678136	6183 48 4		110	6795253	6192 14 9		91
6004850	6178 20 1		170			/pc.		6678198	6183 52 2		119	6494712	6192 15 7		93
6004973	6178 20 3		170					6678259	6183 53 0		117	6795314	6192 16 5		95
6005093	6178 20 5		170	6674657	6182 01 1		95	6678310	6183 55 7		118	6504855	6192 17 3		99
6005215	6178 20 7		170	6674718	6182 06 2		99	6222131	6183 57 3		120	6795376	6192 18 1		100
6005307	6178 20 9		171	6674770	6182 09 7		102	6673933	6183 60 3		90	6795437	6192 21 1		102
6005406	6178 21 1		171	6674831	6182 10 0		103	6673995	6183 61 1		95	6497171	6192 23 8		103
6005505	6178 21 3		171	6674893	6182 11 9		104	6674053	6183 65 4		96	6795499	6192 24 6		104
6005802	6178 22 5		171	6674954	6182 12 7		105	6674114	6183 66 2		99	6795550	6192 25 4		105
6005932	6178 22 7		172	6675012	6182 13 5		106	6674176	6183 69 7		102	6795611	6192 26 2		106
6006052	6178 22 9		172	6675074	6182 14 3		107	6674237	6183 70 0		103	6220878	6192 27 0		107
6006175	6178 23 1		172	6675739	6182 19 4		108	6674299	6183 72 7		104	6360970	6192 31 9		108
6006298	6178 23 3		172	6675791	6182 20 8		109	6674350	6183 73 5		105	6801558	6192 32 7		109
6006410	6178 23 6		173	6675852	6182 21 6		111	6674411	6183 74 3		106	6354559	6192 33 5		111
6009411	6178 30 2		174	6675913	6182 22 4		112	6674473	6183 75 1		107	6353057	6192 34 3		112
6009534	6178 30 5		174	6675975	6182 23 2		113	6678372	6183 80 8		108	6492312	6192 35 1		113
6009657	6178 30 7		174	6676033	6182 24 0		114	6678433	6183 81 6		109	6351855	6192 37 8		114
6009732	6178 31 0		174	6676095	6182 25 9		115	6678495	6183 82 4		111	6795673	6192 38 6		115
6009831	6178 31 2		175	6676156	6182 26 7		110	6678556	6183 83 2		112	6492374	6192 39 4		110
6009930	6178 31 4		175	6676217	6182 30 5		119	6678617	6183 84 0		113	5042464	6192 41 6		119
6010073	6178 31 6		175	6676279	6182 31 3		117	6678679	6183 85 9		114	5042532	6192 42 0		117
6010196	6178 32 0		175	6676330	6182 34 8		118	6678730	6183 86 7		116	5042600	6192 42 4		118
6010318	6178 32 2		176	6501977	6182 36 4		120	6678792	6183 87 5		110	5042693	6192 42 8		120
6010400	6178 32 4		176	6675197	6182 40 2		95	6678853	6183 91 3		119	6796212	6192 45 9		92
6010509	6178 32 6		176	6675258	6182 44 5		99	6678914	6183 92 1		117	6494774	6192 46 7		94
6010608	6178 32 8		176	6675319	6182 48 8		102	6678976	6183 95 6		118	6796274	6192 47 5		95
6010707	6178 33 0		177	6675371	6182 49 6		103	6679034	6183 98 0		120	6504978	6192 48 3		99
6010806	6178 33 4		177	6675432	6182 52 6		104					6796335	6192 49 1		101
6010929	6178 33 6		177	6675494	6182 53 4		105					6796397	6192 51 3		102
6011049	6178 33 8		177	6675555	6182 54 2		106	6794058	6191 00 2		90	6497232	6192 52 1		103
6011162	6178 34 1		178	6675616	6182 55 0		107	6794119	6191 01 0		91	6796458	6192 54 8		104
		/100 pc.		6676392	6182 59 3		108	6494590	6191 02 9		93	6796519	6192 55 6		105
6011285	6178 34 9		184	6676453	6182 60 7		109	6794171	6191 03 7		95	6796571	6192 56 4		106
		/m		6676514	6182 61 5		111	6496938	6191 04 5		96	6500833	6192 57 2		107
6013197	6178 42 0		179	6676576	6182 62 3		112	6505036	6191 05 3		99	6351794	6192 61 0		108
6013319	6178 42 2		179	6676637	6182 63 1		113	6794232	6191 06 1		100	6492435	6192 62 9		109
6013432	6178 42 4		179	6676699	6182 65 8		114	6794294	6191 09 6		102	6712519	6192 63 7		111
6013555	6178 42 6		179	6676750	6182 66 6		115	6497058	6191 11 8		103	6712571	6192 64 5		112
6013678	6178 42 8		180	6676811	6182 67 4		110	6363490	6191 12 6		104	6492497	6192 65 3		113
6013791	6178 43 0		180	6676873	6182 71 2		119	6794355	6191 13 4		105	6712632	6192 66 1		114
6013913	6178 43 5		180	6676934	6182 72 0		117	6794416	6191 14 2		106	6796632	6192 68 8		115
6014033	6178 43 7		180	6676996	6182 74 7		118	6501199	6191 15 0						

Numeric directory

Structure of the EAN number: Country code **40**

Manufacturer code **1219** (for articles beginning with **0: 1010**)

Individual EAN-C **5647589**

EAN-C.	Art. no.	Price	Page	EAN-C.	Art. no.	Price	Page	EAN-C.	Art. no.	Price	Page	EAN-C.	Art. no.	Price	Page
		/pc.				/pc.				/pc.				/pc.	
6796816	6192 79 3		100	6153497	6199 15 0		158	5699019	6247 47 2		153	6315017	6249 59 0		151
6796878	6192 81 5		102	6153374	6199 15 2		158					6977123	6249 61 2		145
6497294	6192 82 3		103	6153435	6199 15 4		158	6652518	6247 49 0		141	6315079	6249 63 9		147
6796939	6192 83 1		104	6153558	6199 15 6		158	6312313	6247 50 4		143	6315130	6249 64 7		149
6796991	6192 85 8		105	6153619	6199 16 3		158	6652273	6247 56 3		141	6315192	6249 65 5		151
6797059	6192 86 6		106	6153671	6199 16 5		158	6312733	6247 57 1		143	6503537	6249 67 1		145
6496990	6192 87 4		107	6153732	6199 16 7		158	6652150	6247 65 2		141	6318254	6249 70 1		147
6712694	6192 91 2		108	6153794	6199 16 9		158	6313150	6247 66 0		143	6318315	6249 72 8		149
6492619	6192 92 0		109	6153855	6199 18 0		158	6652396	6247 72 5		141	6318377	6249 73 6		151
6712755	6192 93 9		111	6153916	6199 18 2		158	6317592	6247 73 3		143	6503292	6249 79 5		145
6712816	6192 94 7		112	6153978	6199 18 4		158	6652631	6247 88 1		141	6575770	6249 81 7		147
6492671	6192 95 5		113	6154036	6199 18 6		158	6575114	6247 90 3		144	6575831	6249 82 5		149
6712878	6192 96 3		114					6503476	6247 98 9		145	6575893	6249 83 3		151
6797110	6192 97 1		115	6154098	6199 20 2		160					6018598	6249 84 2		138
6492732	6192 99 8		110	6154159	6199 20 4		160	6312559	6248 00 4		147	6018710	6249 84 4		139
				6154210	6199 20 6		160	6312610	6248 01 2		149				
5042488	6193 02 1		119	6154272	6199 20 8		160	6312672	6248 02 0		151	5691020	6249 84 5		140
5042570	6193 02 5		117					6977062	6248 04 7		145				
5042648	6193 02 9		118	6154333	6199 22 3		160	6312979	6248 06 3		147	6018833	6249 84 6		142
5042716	6193 03 3		120	6154395	6199 22 5		160	6313037	6248 07 1		149	6018956	6249 84 8		144
6797172	6193 09 9		90	6154456	6199 22 7		160	6313099	6248 09 8		151	6019076	6249 85 0		146
6797233	6193 10 2		92	6154517	6199 22 9		160	6977185	6248 12 8		145	5020325	6249 85 2		148
6975624	6193 11 0		94	6154579	6199 23 2		160	6313396	6248 14 4		147	5020387	6249 85 4		150
6797295	6193 12 9		95	6154630	6199 23 4		160	6313457	6248 15 2		149	5020394	6249 85 6		152
6976768	6193 13 7		96	6154692	6199 23 6		160	6313518	6248 16 0		151				
6504794	6193 14 5		99	6155774	6199 23 8		160	6503599	6248 18 7		145	5691037	6249 86 5		154
6797356	6193 15 3		101	6155835	6199 25 1		160	6317837	6248 20 9		147				
6797417	6193 18 8		102	6155897	6199 25 3		160	6317899	6248 21 7		149			/m	
6497355	6193 19 6		103	6155958	6199 25 5		160	6317950	6248 22 5		151	6644896	6249 87 6		155
6712939	6193 21 8		104	6156016	6199 25 7		160	6503353	6248 28 4		145			/pc.	
6797479	6193 22 6		105	6156078	6199 26 2		160	6575596	6248 30 6		147	5685081	6249 88 1		148
6797530	6193 23 4		106	6156139	6199 26 4		160	6575657	6248 31 4		149			/100 pc.	
6974788	6193 24 2		107	6156313	6199 26 6		160	6575718	6248 32 2		151	6119233	6249 88 4		155
6712991	6193 28 5		108	6156375	6199 26 8		160					6119295	6249 88 8		155
6492794	6193 29 3		109	6156559	6199 28 1		160	5699026	6248 32 8		153			/pc.	
6713059	6193 30 7		111	6156498	6199 28 3		160	5699033	6248 33 2		153	6315376	6249 90 6		143
6713110	6193 31 5		112	6156610	6199 28 5		160	5699040	6248 33 6		153	6315499	6249 92 2		155
6492855	6193 32 3		113	6156672	6199 28 7		160	5699057	6248 34 0		153	6315611	6249 96 5		155
6713172	6193 33 1		114	6156795	6199 40 2		159	5699064	6248 34 4		153	6315673	6249 98 1		155
6797592	6193 35 8		116	6156733	6199 40 4		159	5699095	6248 42 8		153				
6492916	6193 36 6		110	6156856	6199 40 6		159	5699101	6248 43 2		153	5030898	6257 59 8		200
5042518	6193 38 7		119	6156979	6199 40 8		159	5699118	6248 43 6		153	6800711	6257 60 3		200
5042587	6193 39 1		117	6157037	6199 42 1		159	5699125	6248 45 0		153				
5042655	6193 39 5		118	6157099	6199 42 3		159	5699156	6248 45 4		153	6043156	6258 06 9		355
5042723	6193 39 9		120	6157211	6199 42 5		159					6279739	6258 07 1		355
6223695	6193 50 1		91	6157570	6199 42 7		159					5406006	6258 07 3		355
6975266	6193 52 8		93	6157938	6199 44 2		159	6651795	6248 46 2		138				
6507313	6193 56 0		100	6158294	6199 44 4		159	6119059	6248 47 0		139	5406013	6258 07 4		355
				6158652	6199 44 6		159					5469148	6258 14 1		346
6448272	6194 03 6		122	6158713	6199 44 8		159	5690962	6248 48 2		140				
6448098	6194 04 4		123	6158775	6199 46 1		159								
6447978	6194 05 2		123	6158836	6199 46 3		159	6651856	6248 49 7		141	5427650	6270 67 0		196
6447497	6194 06 0		124	6158898	6199 46 5		159	6313570	6248 51 9		143				
6628636	6194 10 9		123	6158959	6199 46 7		159	6977307	6248 60 8		145			/m	
6628575	6194 11 7		123					6313815	6248 62 4		147	5655473	6274 30 0		208
6628513	6194 12 5		123					6313877	6248 64 0		149	5656333	6274 30 1		208
6628452	6194 13 3		124	5126522	6246 05 2		313	6313938	6248 66 7		151	5656340	6274 30 2		208
6628391	6194 14 1		124	5126539	6246 08 7		313					5656371	6274 30 6		208
6628339	6194 18 4		123					5691013	6248 69 4		153			/pc.	
6618910	6194 19 2		123	6651672	6246 96 6		138					5656401	6274 31 0		209
6618859	6194 20 6		124	6118878	6246 97 4		139					5656432	6274 31 1		209
6349814	6194 21 4		124					6652570	6248 99 3		141	5656449	6274 31 2		209
6629350	6194 72 9		125	5690955	6246 98 2		140					5656456	6274 31 6		209
				6651733	6246 99 0		141	6313990	6249 00 0		143	5655664	6274 32 0		209
		/m						6652334	6249 08 6		141	5656463	6274 32 1		209
6096329	6199 10 3		158	6311897	6247 01 6		143	6314232	6249 09 4		143	5656494	6274 32 2		209
6096206	6199 10 5		158	6977369	6247 09 1		145	6652211	6249 16 7		141	5656500	6274 32 6		209
6096381	6199 10 7		158	6312139	6247 11 3		147								

EAN-C.	Art. no.	Price	Page	EAN-C.	Art. no.	Price	Page	EAN-C.	Art. no.	Price	Page	EAN-C.	Art. no.	Price	Page
		/pc.				/pc.				/pc.				/pc.	
5656692	6274 49 0		209	5657668	6274 84 2		308	5659631	6277 12 1		222	5661900	6277 51 0		232
5656708	6274 49 1		209	5657712	6274 85 0		309	5659648	6277 12 2		222	5661917	6277 51 1		232
5656715	6274 49 2		209	5657729	6274 85 1		309	5659709	6277 14 0		223	5661924	6277 51 2		232
5656722	6274 49 6		209	5657767	6274 85 2		309	5659747	6277 14 1		223	5661986	6277 52 0		232
		/m													
5656739	6274 50 0		211	5657774	6274 85 6		309	5659754	6277 14 2		223	5661993	6277 52 1		232
5656746	6274 50 1		211	5657781	6274 86 0		309	5659815	6277 16 0		223	5662006	6277 52 2		232
5656746	6274 50 1		211	5657828	6274 86 1		309	5659822	6277 16 1		223	5662020	6277 53 0		233
5656753	6274 50 2		211	5657835	6274 86 2		309	5659860	6277 16 2		223	5662037	6277 53 1		233
5656760	6274 50 6		211	5657842	6274 86 6		309	5659921	6277 17 0		224	5662044	6277 53 2		233
		/pc.													
5656791	6274 51 0		212	5657880	6274 87 0		309	5659938	6277 17 1		224	5662075	6277 54 0		233
5656807	6274 51 1		212	5657897	6274 87 1		309	5659945	6277 17 2		224	5662082	6277 54 1		233
5656814	6274 51 2		212	5657903	6274 87 2		309			/m		5662099	6277 54 2		233
5656821	6274 51 6		212	5657941	6274 87 6		309	5660002	6277 20 0		225	5662129	6277 56 0		234
5656838	6274 52 0		212	5657958	6274 88 0		310	5660040	6277 20 1		225	5662136	6277 56 1		234
5656845	6274 52 1		212	5657965	6274 88 1		310	5660057	6277 20 2		225	5662143	6277 56 2		234
5656852	6274 52 2		212	5658009	6274 88 2		310			/pc.				/m	
5656869	6274 52 6		212	5658023	6274 89 0		209	5660163	6277 21 0		227	5662174	6277 60 0		236
5656876	6274 52 6		212	5658061	6274 89 1		209	5660170	6277 21 1		227	5662181	6277 60 1		236
5656886	6274 54 0		213	5658078	6274 89 2		209	5660187	6277 21 2		227	5662198	6277 60 2		236
5656883	6274 54 1		213	5658085	6274 89 6		209	5660248	6277 22 0		227			/pc.	
5656890	6274 54 2		213					5660286	6277 22 1		227	5662242	6277 61 0		238
5656906	6274 54 6		213	5658122	6274 90 0		210	5660293	6277 22 2		227	5662259	6277 61 1		238
5656913	6274 56 0		213			/pc.		5660323	6277 24 0		228	5662266	6277 61 2		238
5656920	6274 56 1		213	5658139	6274 91 0		307	5660330	6277 24 1		228	5662310	6277 62 0		238
5656937	6274 56 2		213	5658146	6274 91 1		307	5660347	6277 24 2		228	5662327	6277 62 1		238
5656944	6274 56 6		213	5658184	6274 91 2		307	5660408	6277 26 0		228	5662334	6277 62 2		238
5656951	6274 57 0		213	5658207	6274 92 0		308	5660415	6277 26 1		228	5662365	6277 64 0		239
5656968	6274 57 1		213	5658245	6274 92 1		308	5660422	6277 26 2		228	5662372	6277 64 1		239
5656975	6274 57 2		213	5658252	6274 92 2		308	5660484	6277 27 0		229	5662389	6277 64 2		239
5656982	6274 57 6		213	5658306	6274 93 0		308	5660521	6277 27 1		229	5662419	6277 66 0		239
5656999	6274 59 0		210	5658313	6274 93 1		308	5660538	6277 27 2		229	5662426	6277 66 1		239
5657002	6274 59 1		210	5658320	6274 93 2		308	5660590	6277 29 0		220	5662433	6277 66 2		239
5657019	6274 59 2		210	5658375	6274 94 0		308					5662464	6277 67 0		240
5657026	6274 59 6		210	5658382	6274 94 1		308	5700852	6277 29 4		220	5662471	6277 67 1		240
5657033	6274 65 0		208	5658429	6274 94 2		308			/m		5662488	6277 67 2		240
		/m												/m	
5657040	6274 70 0		214	5658443	6274 95 0		309	5660606	6277 30 0		225	5662518	6277 70 0		236
5657057	6274 70 1		214	5658481	6274 95 1		309	5660644	6277 30 1		225	5662525	6277 70 1		236
5657064	6274 70 2		214	5658498	6274 95 2		309	5660651	6277 30 2		225	5662532	6277 70 2		236
5657071	6274 70 6		214	5658542	6274 96 0		309			/pc.				/pc.	
		/pc.													
5657101	6274 71 0		215	5658559	6274 96 1		309	5660767	6277 31 0		227	5662587	6277 71 0		238
5657118	6274 71 1		215	5658566	6274 96 2		309	5660774	6277 31 1		227	5662594	6277 71 1		238
5657125	6274 71 2		215	5658580	6274 97 0		309	5660781	6277 31 2		227	5662600	6277 71 2		238
5657132	6274 71 6		215	5658603	6274 97 2		309	5660811	6277 32 0		227	5662631	6277 72 0		238
5657149	6274 72 0		215	5658627	6274 98 0		310	5660828	6277 32 1		227	5662648	6277 72 1		238
5657156	6274 72 1		215	5658665	6274 98 1		310	5660835	6277 32 2		227	5662679	6277 72 2		238
5657163	6274 72 2		215	5658672	6274 98 2		310	5660866	6277 34 0		228	5662709	6277 74 0		239
5657170	6274 72 6		215					5660873	6277 34 1		228	5662716	6277 74 1		239
5657187	6274 74 0		216			/m		5660880	6277 34 2		228	5662723	6277 74 2		239
5657194	6274 74 1		216	5658726	6277 00 0		220	5660941	6277 36 0		228	5662754	6277 76 0		239
5657200	6274 74 2		216	5658733	6277 00 1		220	5660958	6277 36 1		228	5662761	6277 76 1		239
5657217	6274 74 6		216	5658740	6277 00 2		220	5660965	6277 36 2		228	5662815	6277 76 2		239
5657224	6274 76 0		216			/pc.		5661023	6277 37 0		229	5662877	6277 77 0		240
5657231	6274 76 1		216	5658856	6277 01 0		222	5661061	6277 37 1		229	5662884	6277 77 1		240
5657248	6274 76 2		216	5658863	6277 01 1		222	5661078	6277 37 2		229	5662914	6277 77 2		240
5657255	6274 76 6		216	5658900	6277 01 2		222			/m				/m	
5657262	6274 77 0		216	5658962	6277 02 0		222	5661139	6277 40 0		230	5662945	6277 80 0		241
5657279	6274 77 1		216	5658979	6277 02 1		222	5661146	6277 40 1		230	5662976	6277 80 1		241
5657286	6274 77 2		216	5658986	6277 02 2		222	5661184	6277 40 2		230	5662983	6277 80 2		241
5657293	6274 77 6		216	5659044	6277 04 0		223			/pc.				/pc.	
5657309	6274 79 0		209	5659082	6277 04 1		223	5661269	6277 41 0		232	5663034	6277 81 0		243
5657347	6274 79 1		209	5659099	6277 04 2		223	5661306	6277 41 1		232	5663041	6277 81 1		243
5657354	6274 79 2		209	5659150	6277 06 0		223	5661313	6277 41 2		232	5663058	6277 81 2		243
5657361	6274 79 6		209	5659167	6277 06 1		223	5661375	6277 42 0		232	5663102	6277 82 0		243
5657408	6274 81 0		307	5659204	6277 06 2		223	5661382	6277 42 1		232	5663119	6277 82 1		243
5657415	6274 81 1		307	5659228	6277 07 0		224	5661429	6277 42 2		232	5663126	6277 82 2		243
5657422	6274 81 2		307	5659266	6277 07 1		224	5661443	6277 43 0		233	5663140	6277 83 0		244
5657460	6274 81 6		307	5659273	6277 07 2		224	5661481	6277 43 1		233	5663157	6277 83 1		244
5657477	6274 82 0		308			/m		5661498	6277 43 2		233	5663164	6277 83 2		244
5657484	6274 82 1		308	5659334	6277 09 0		224	5661559	6277 44 0		233	5663195	6277 84 0		244
5657521	6274 82 2		308	5659341	6277 09 5		224	5661566	6277 44 1		233	5663201	6277 84 1		244
5657538	6274 82 6		308	5659389	6277 10 0		220	5661603	6277 44 2		233	5663			

Numeric directory

Structure of the EAN number: Country code **40**

Manufacturer code **1219** (for articles beginning with **0: 1010**)

Individual EAN-C **5647589**

EAN-C.	Art. no.	Price	Page	EAN-C.	Art. no.	Price	Page	EAN-C.	Art. no.	Price	Page	EAN-C.	Art. no.	Price	Page
		/pc.				/pc.				/pc.				/pc.	
5663409	6277 91 0		243	5665083	6278 26 0		250	5666776	6278 82 0		311	5680864	6279 83 2		306
5663416	6277 91 1		243	5665090	6278 26 1		250	5666783	6278 82 1		311	5680871	6279 83 4		306
5663423	6277 91 2		243	5665106	6278 26 2		250	5666820	6278 82 2		311	5680888	6279 83 6		306
5663478	6277 92 0		243			/m		5666875	6278 83 0		311	5680895	6279 83 8		306
5663485	6277 92 1		243	5665137	6278 30 0		247	5666882	6278 83 1		311	5680901	6279 84 0		306
5663515	6277 92 2		243	5665144	6278 30 1		247	5666899	6278 83 2		311	5680918	6279 84 2		306
5663539	6277 93 0		244	5665151	6278 30 2		247	5666929	6278 84 0		311				
5663546	6277 93 1		244			/pc.		5666936	6278 84 1		311			/m	
5663577	6277 93 2		244	5665205	6278 31 0		249	5666943	6278 84 2		311	5695813	6279 85 0		221
5663607	6277 94 0		244	5665212	6278 31 1		249	5666974	6278 85 0		312	5695820	6279 85 1		221
5663638	6277 94 1		244	5665229	6278 31 2		249	5666981	6278 85 1		312	5695868	6279 85 2		221
5663645	6277 94 2		244	5665250	6278 32 0		249	5666998	6278 85 2		312			/pc.	
5663690	6277 96 0		245	5665267	6278 32 1		249	5667025	6278 86 0		312	5695936	6279 86 0		223
5663706	6277 96 1		245	5665274	6278 32 2		249	5667056	6278 86 1		312	5695943	6279 86 1		223
5663713	6277 96 2		245	5665335	6278 33 0		249	5667063	6278 86 2		312	5695981	6279 86 2		223
				5665342	6278 33 1		249	5667094	6278 87 0		312	5696056	6279 87 0		222
		/m		5665380	6278 33 2		249	5667100	6278 87 1		312	5696063	6279 87 1		222
5663744	6278 00 0		252	5665458	6278 34 0		250	5667117	6278 87 2		312	5696100	6279 87 2		222
5663751	6278 00 1		252	5665465	6278 34 1		250	5667148	6278 88 0		310				
5663768	6278 00 2		252	5665472	6278 34 2		250	5667179	6278 88 1		310			/m	
		/pc.		5665502	6278 36 0		250	5667186	6278 88 2		310	5680925	6279 88 0		248
5663812	6278 01 0		254	5665519	6278 36 1		250	5667216	6278 89 0		310	5680932	6279 88 1		248
5663829	6278 01 1		254	5665526	6278 36 2		250	5667223	6278 89 1		310	5680949	6279 88 2		248
5663836	6278 01 2		254			/m		5667230	6278 89 2		310			/pc.	
5663867	6278 02 0		254	5665557	6278 40 0		258					5681090	6279 99 0		250
5663874	6278 02 1		254	5665564	6278 40 1		258	5667261	6279 00 0		311	5681106	6279 99 1		250
5663881	6278 02 2		254	5665571	6278 40 2		258	5667278	6279 00 1		311	5681113	6279 99 2		250
5663904	6278 03 0		255			/pc.		5667285	6279 00 2		311				
5663911	6278 03 1		255	5665625	6278 41 0		260	5667315	6279 01 0		311			/m	
5663928	6278 03 2		255	5665632	6278 41 1		260	5667322	6279 01 1		311	5140870	6284 40 0		272
5663959	6278 05 0		255	5665649	6278 41 2		260	5667353	6279 01 2		311	5140887	6284 40 3		272
5663966	6278 05 1		255	5665700	6278 42 0		260	5667384	6279 02 0		311			/pc.	
5663973	6278 05 2		255	5665755	6278 42 1		260	5667414	6279 02 1		311	5140917	6284 41 0		273
5664000	6278 06 0		256	5665762	6278 42 2		260	5667421	6279 02 2		311	5140924	6284 41 3		273
5664017	6278 06 1		256	5665816	6278 43 0		261	5667476	6279 03 0		312	5140931	6284 42 0		273
5664024	6278 06 2		256	5665823	6278 43 1		261	5667483	6279 03 1		312	5140948	6284 42 3		273
5664055	6278 07 0		256	5665878	6278 43 2		261	5667490	6279 03 2		312	5140979	6284 43 0		273
5664062	6278 07 1		256	5665939	6278 44 0		261	5667520	6279 04 0		312	5140986	6284 43 3		273
5664079	6278 07 2		256	5665946	6278 44 1		261	5667537	6279 04 1		312	5140993	6284 44 0		273
		/m		5665984	6278 44 2		261	5667544	6279 04 2		312	5141006	6284 44 3		273
5664109	6278 10 0		252	5666042	6278 46 0		262	5667599	6279 05 0		312	5141044	6284 46 0		273
5664116	6278 10 1		252	5666059	6278 46 1		262	5667605	6279 05 1		312	5141051	6284 46 3		273
5664123	6278 10 2		252	5666066	6278 46 2		262	5667612	6279 05 2		312	5141068	6284 47 0		274
		/pc.				/m		5667667	6279 76 0		221	5141099	6284 47 3		274
5664178	6278 11 0		254	5666097	6278 50 0		258	5667674	6279 76 1		221			/m	
5664185	6278 11 1		254	5666103	6278 50 1		258	5667681	6279 76 2		221	5141105	6284 50 0		275
5664192	6278 11 2		254	5666110	6278 50 2		258	5667704	6279 76 4		226	5141112	6284 50 3		275
5664222	6278 12 0		254			/pc.		5667711	6279 76 5		226			/pc.	
5664239	6278 12 1		254	5666165	6278 51 0		260	5667728	6279 76 6		226	5141129	6284 51 0		276
5664246	6278 12 2		254	5666172	6278 51 1		260	5667742	6279 76 8		237	5141150	6284 51 3		276
5664260	6278 13 0		255	5666189	6278 51 2		260	5667759	6279 76 9		237	5141167	6284 52 0		276
5664307	6278 13 1		255	5666219	6278 52 0		260	5667766	6279 77 0		237	5141174	6284 52 3		276
5664314	6278 13 2		255	5666226	6278 52 1		260	5667780	6279 77 2		253	5141181	6284 53 0		276
5664376	6278 14 0		255	5666233	6278 52 2		260	5667797	6279 77 3		253	5141211	6284 53 3		276
5664383	6278 14 1		255	5666257	6278 53 0		261	5667803	6279 77 4		253	5141228	6284 54 0		276
5664420	6278 14 2		255	5666264	6278 53 1		261	5667827	6279 77 6		221	5141235	6284 54 3		276
5664482	6278 16 0		256	5666271	6278 53 2		261	5667834	6279 77 7		221	5141242	6284 56 0		276
5664499	6278 16 1		256	5666301	6278 54 0		261	5667841	6279 77 8		221	5141273	6284 56 3		276
5664505	6278 16 2		256	5666318	6278 54 1		261	5667865	6279 78 0		226	5141280	6284 57 0		277
5664567	6278 17 0		256	5666325	6278 54 2		261	5667872	6279 78 1		226	5141297	6284 57 3		277
5664604	6278 17 1		256	5666356	6278 56 0		262	5667889	6279 78 2		226			/m	
5664611	6278 17 2		256	5666363	6278 56 1		262	5667902	6279 78 4		237	5141303	6284 60 0		278
		/m		5666370	6278 56 2		262	5667919	6279 78 5		237	5141334	6284 60 3		278
5664666	6278 20 0		247			/m		5667926	6279 78 6		237			/pc.	
5664673	6278 20 1		247	5666400	6278 68 0		208	5667940	6279 78 8		253	5141341	6284 61 0		279
5664680	6278 20 2		247	5666417	6278 68 1		208	5667957	6279 78 9		253	5141358	6284 61 3		279
		/pc.		5666424	6278 68 2		208	5667964	6279 79 0		253	5141365	6284 62 0		279
5664789	6278 21 0		248	5666486	6278 68 6		208	5680680	6279 80 0		305	5141396	6284 62 3		279
5664796	6278 21 1		248	5666530	6278 78 0		209	5680697	6279 80 2		304	5141402	6284 63 0		279
5664802	6278 21 2		248	5666547	6278 78 1		209	5680703	6279 80 4		304	5141419	6284 63 3		279
5664833	6278 22 0		249	5666554	6278 78 2		209	5680734	6279 80 6		304	5141426	6284 64 0		279
5664840	6278 22 1		249	5666578	6278 78 6		209	5680741	6279 81 0		304	5141457	6284 64 3		279
5664857	6278 22 2		249			/pc.		5680758	6279 81 2		304	5141464	6284 66 0		279

Numeric directory

EAN-C.	Art. no.	Price	Page	EAN-C.	Art. no.	Price	Page	EAN-C.	Art. no.	Price	Page	EAN-C.	Art. no.	Price	Page
		/pc.				/pc.				/pc.				/pc.	
5141549	6284 71 0		282	5142201	6285 22 0		297	5143734	6286 50 0		334	5297260	6288 08 6		306
5141570	6284 71 3		282	5142232	6285 22 3		297	5143741	6286 50 2		334	5297277	6288 08 8		306
5141587	6284 72 0		282	5142249	6285 23 0		297	5143758	6286 50 3		334	5297284	6288 09 0		306
5141594	6284 72 3		282	5142256	6285 23 3		297	5143765	6286 55 0		316	5297291	6288 09 2		306
5141600	6284 73 0		282	5142263	6285 24 0		297	5143819	6286 56 0		316	5147152	6288 10 0		305
5141631	6284 73 3		282	5142294	6285 24 3		297	5143888	6286 70 0		332	5147169	6288 10 2		305
5141648	6284 74 0		282	5142300	6285 26 0		297	5143918	6286 70 2		332	5147176	6288 10 4		305
5141655	6284 74 3		282	5142317	6285 26 3		297			/m		5147183	6288 10 6		305
5141662	6284 76 0		282	5142324	6285 27 0		298	5143925	6286 75 0		318	5147213	6288 10 8		305
5141693	6284 76 3		282	5142355	6285 27 3		298	5143932	6286 75 2		318	5147220	6288 11 0		305
5141709	6284 77 0		283			/m		5143949	6286 75 4		318	5147237	6288 11 2		305
5141716	6284 77 3		283	5142362	6285 30 0		299	5143970	6286 75 6		318	5147244	6288 11 4		305
		/m		5142379	6285 30 3		299	5143987	6286 75 8		318	5147275	6288 11 6		305
5141723	6284 80 0		284			/pc.				/pc.		5147282	6288 11 8		305
5141754	6284 80 3		284	5142386	6285 31 0		300	5143994	6286 77 0		318	5147299	6288 12 0		305
		/pc.		5142416	6285 31 3		300	5144007	6286 77 2		318	5147404	6288 18 0		306
5141761	6284 81 0		285	5142423	6285 32 0		300	5144038	6286 77 5		318	5616559	6288 36 5		357
5141778	6284 81 3		285	5142430	6285 32 3		300	5144045	6286 80 0		316				
5141785	6284 82 0		285	5142447	6285 33 0		300	5144052	6286 80 2		317	5694915	6288 36 9		357
5141815	6284 82 3		285	5142478	6285 33 3		300	5144090	6286 81 0		332				
5141822	6284 83 0		285	5142485	6285 34 0		300			/m		5148562	6288 57 0		331
5141839	6284 83 3		285	5142492	6285 34 3		300			/m		5148579	6288 57 1		331
5141846	6284 84 0		285	5142508	6285 36 0		300	5157618	6287 16 0		291				
5141877	6284 84 3		285	5142539	6285 36 3		300	5157625	6287 16 3		291	5480969	6288 57 5		338
5141884	6284 86 0		285	5142546	6285 37 0		301	5145189	6287 17 0		266				
5141891	6284 86 3		285	5142553	6285 37 3		301	5145196	6287 17 3		266	5148586	6288 58 0		331
5141907	6284 87 0		286			/m				/pc.		5148593	6288 58 1		331
5141938	6284 87 3		286	5157069	6285 40 0		266	5145240	6287 20 0		267	5148678	6288 61 0		208
		/m		5157076	6285 40 3		266	5145257	6287 20 3		267	5148685	6288 61 1		208
5141945	6284 90 0		287			/pc.		5145264	6287 21 0		267	5148715	6288 61 2		356
5141952	6284 90 3		287	5157083	6285 41 0		267	5145295	6287 21 3		267	5148739	6288 61 4		357
		/pc.		5157120	6285 41 3		267	5157663	6287 22 0		292	5148746	6288 61 5		208
5141969	6284 91 0		288	5157137	6285 42 0		267	5157670	6287 22 3		292	5404385	6288 61 6		355
5141990	6284 91 3		288	5157144	6285 42 3		267	5157687	6287 23 0		291	5404392	6288 61 7		355
5142003	6284 92 0		288	5157182	6285 43 0		267	5157724	6287 23 3		291	5404408	6288 61 8		355
5142010	6284 92 3		288	5157199	6285 43 3		267			/m		5404415	6288 61 9		355
5142027	6284 93 0		288	5157205	6285 44 0		267	5146575	6287 70 0		307	5404422	6288 62 0		355
5142058	6284 93 3		288	5157243	6285 44 3		267	5146582	6287 70 1		307	5404439	6288 62 1		355
5142065	6284 94 0		288	5157250	6285 46 0		267	5146612	6287 70 2		307	5404446	6288 62 2		356
5142072	6284 94 3		288	5157267	6285 46 3		267	5146643	6287 71 0		307	5404453	6288 62 3		356
5142089	6284 96 0		288	5157304	6285 47 0		268	5146674	6287 71 1		307	5404460	6288 62 4		356
5142119	6284 96 3		288	5157311	6285 47 3		268	5146681	6287 71 2		307	5404477	6288 62 5		356
5142126	6284 97 0		289			/m		5146704	6287 72 3		307	5404484	6288 62 6		356
5142133	6284 97 3		289	5157328	6285 50 0		269	5146742	6287 73 3		307	5404491	6288 62 7		356
		/m		5157366	6285 50 3		269			/pc.		5404507	6288 62 8		356
5156581	6285 00 0		290	5157373	6285 51 0		270	5146766	6287 80 0		307	5404514	6288 62 9		356
5156598	6285 00 3		290	5157380	6285 51 3		270	5146797	6287 81 0		307	5404521	6288 63 0		356
		/pc.		5157427	6285 52 0		270	5676140	6288 00 1		304	5404538	6288 63 1		356
5156604	6285 01 0		291	5157434	6285 52 3		270	5676188	6288 00 3		304	5404545	6288 63 2		356
5156642	6285 01 3		291	5157441	6285 53 0		270	5676195	6288 00 5		304	5404552	6288 63 3		356
5156659	6285 02 0		291	5157489	6285 53 3		270	5676201	6288 00 7		304	5148777	6288 64 0		210
5156666	6285 02 3		291	5157496	6285 54 0		270	5146865	6288 03 0		306	5148791	6288 65 0		313
5156703	6285 03 0		291	5157502	6285 54 3		270	5146872	6288 03 2		306			/m	
5156710	6285 03 3		291	5157540	6285 56 0		270	5146889	6288 03 4		306	5685760	6288 65 1		313
5156727	6285 04 0		292	5157557	6285 56 3		270	5146919	6288 03 6		306			/pc.	
5156765	6285 04 3		292	5157564	6285 57 0		271	5146926	6288 03 8		306			/pc.	
5156772	6285 06 0		292	5157601	6285 57 3		271	5146933	6288 04 0		306	5148913	6288 66 7		266
5156789	6285 06 3		292					5146940	6288 04 2		306	5149088	6288 70 0		221
		/m		5142560	6286 00 0		318	5146971	6288 04 4		306	5149101	6288 70 4		224
5156826	6285 10 0		293	5142607	6286 00 3		318	5146988	6288 04 6		306	5149460	6288 79 0		208
5156833	6285 10 3		293	5142980	6286 11 0		318	5146995	6288 04 8		306			/m	
		/pc.		5143017	6286 11 3		318	5147008	6288 05 0		306	5149521	6288 83 0		318
5156840	6285 11 0		294	5143079	6286 13 0		318	5147039	6288 05 2		306			/pc.	
5156888	6285 11 3		294	5143086	6286 13 3		318	5147046	6288 05 4		306	5160564	6288 92 0		320
5156895	6285 12 0		294	5143161	6286 16 0		318	5147053	6288 05 6		306	5160601	6288 92 3		320
5156901	6285 12 3		294	5143192	6286 16 3		318	5147060	6288 05 8		306	5160663	6288 93 0		319
5156949	6285 13 0		294	5143208	6286 17 0		318	5147091	6288 06 0		306	5160670	6288 93 3		319
5156956	6285 13 3		294	5143222	6286 17 3		318	5147107	6288 06 2		306	5160731	6288 94 0		322
5156963	6285 14 0		295	5143284	6286 19 0		318	5147114	6288 06 4		306	5160748	6288 94 3		322
5157007	6285 14 3		295	5143314	6286 19 3		318	5147121	6288 06 6		306	5160809	6288 95 0		323
5157014	6285 16 0		295	5143321	6286 20 0		318	5297185	6288 07 0		306	5160847	6288 95 3		323
5157021	6285 16 3		295	5143338	6286 20 3		318	5297192	6288 07 2		306	5160861	6288 96 0		324
		/m		5143383	6286 22 0		318	5297208	6288 07 4		306	5160908	6288 96 3		324
5142140	6285 20 0		296	5143406	6286 22 3		318	5297215	6288 07 6		306	5160960	6288 97 0		325
5142171	6285 20 3														

Numeric directory

EAN-C.	Art. no.	Price	Page
		/pc.	
5477419	6289 05 0		329
5477020	6289 05 3		329
5477037	6289 06 0		327
5477426	6289 06 3		327
5477433	6289 07 0		329
5477044	6289 07 3		329
5161202	6290 01 0		321
5161219	6290 01 3		321
5161226	6290 02 0		333
5161264	6290 02 3		333
5161288	6290 03 0		333
5161325	6290 03 3		333
5161349	6290 04 0		333
5161387	6290 04 3		333
5161448	6290 05 0		333
5161455	6290 05 3		333
5161509	6290 06 0		333
5161516	6290 06 3		333
5161561	6290 07 3		334
5428077	6290 08 2		326
5428084	6290 08 3		326
5428091	6290 08 6		325
5428107	6290 08 7		325
5428138	6290 09 0		334
5428145	6290 09 1		334
5161578	6290 10 0		322
5161585	6290 10 4		322
5161639	6290 11 0		323
5161646	6290 11 4		323
5161691	6290 12 0		319
5161707	6290 12 4		319
5161752	6290 13 0		324
5161769	6290 13 4		324
5161813	6290 15 0		319
5161868	6290 16 0		319
5161882	6290 17 0		322
5161929	6290 17 2		323
5161936	6290 17 4		319
5161943	6290 17 6		324
5428152	6290 17 8		326
5161981	6290 18 0		331
5162001	6290 18 4		331
5459231	6290 19 6		326
5459248	6290 19 7		326
5459279	6290 19 8		326
5162063	6290 20 0		320
5465249	6290 20 1		331
5162117	6290 22 0		323
5162162	6290 24 0		322
5162179	6290 25 0		325
5418566	6290 26 0		320
5428169	6290 26 4		326
5448792	6290 26 9		327
5648963	6290 29 0		327
5733195	9002 09 7		307

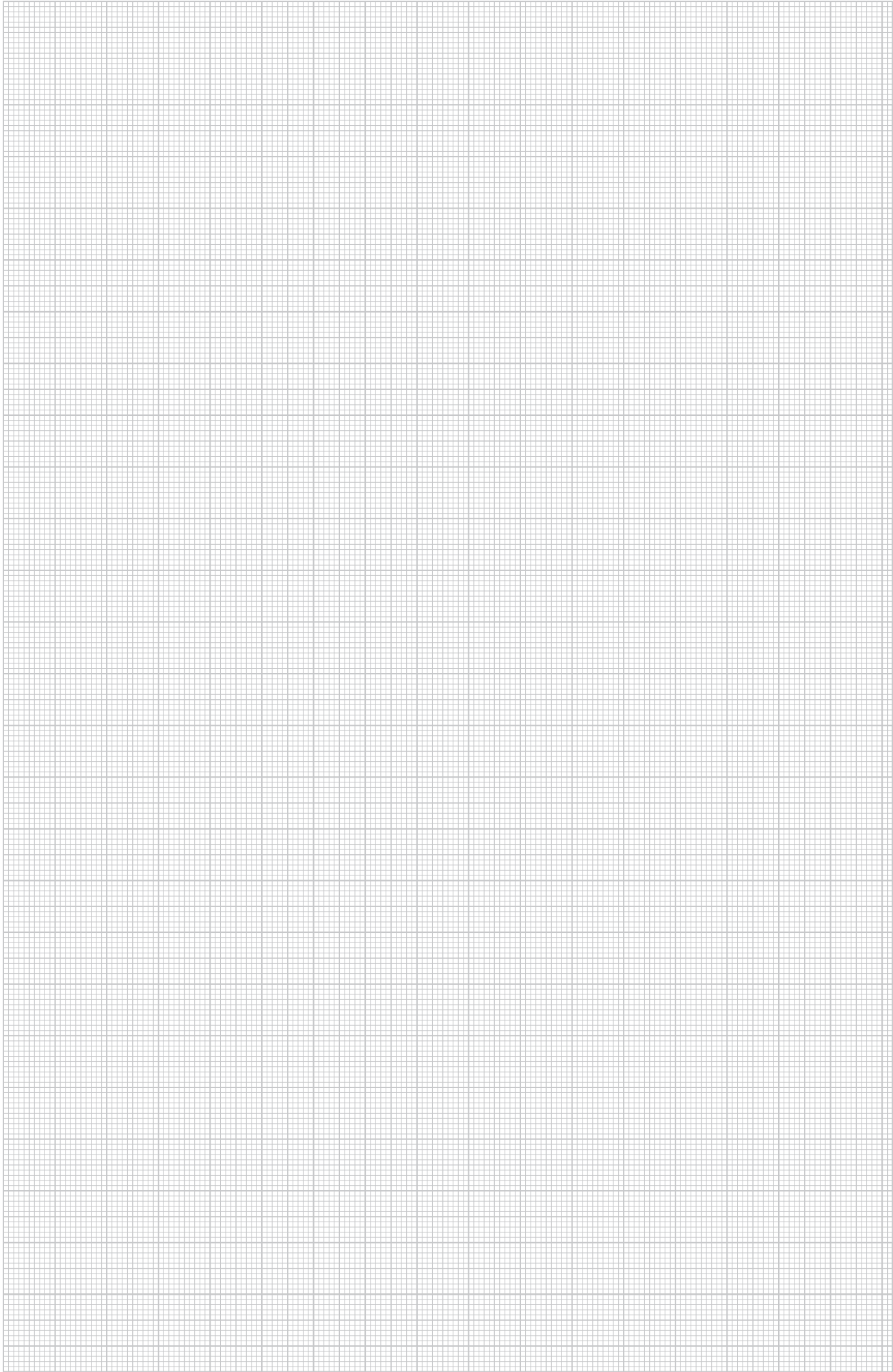

Type listing

Structure of the EAN number: Country code **40**

Manufacturer code **1219** (for articles beginning with **0: 1010**)

Individual EAN-C **5647589**

Type	Dimensions/Colour/Div.	EAN-C.	Art. no.	Price	Page	Type	Dimensions/Colour/Div.	EAN-C.	Art. no.	Price	Page
7LSB	300	5148791	6288 65 0	/pc.	313	71GD6	Grey/ PA	5148746	6288 61 5	/pc.	258
						71GD6	Grey/ PA	5148746	6288 61 5		266
						71GD6	Grey/ PA	5148746	6288 61 5		269
						71GD6	Grey/ PA	5148746	6288 61 5		272
7LSB M		5685760	6288 65 1	/m	313	71GD6	Grey/ PA	5148746	6288 61 5		275
						71GD6	Grey/ PA	5148746	6288 61 5		278
						71GD6	Grey/ PA	5148746	6288 61 5		281
						71GD6	Grey/ PA	5148746	6288 61 5		284
7ZE	/ PA	5149460	6288 79 0	/pc.	208	71GD6	Grey/ PA	5148746	6288 61 5		287
7ZE	/ PA	5149460	6288 79 0		211	71GD6	Grey/ PA	5148746	6288 61 5		290
7ZE	/ PA	5149460	6288 79 0		214	71GD6	Grey/ PA	5148746	6288 61 5		293
7ZE	/ PA	5149460	6288 79 0		221	71GD6	Grey/ PA	5148746	6288 61 5		296
7ZE	/ PA	5149460	6288 79 0		226	71GD6	Grey/ PA	5148746	6288 61 5		299
7ZE	/ PA	5149460	6288 79 0		231	71GD6	Grey/ PA	5148746	6288 61 5		331
7ZE	/ PA	5149460	6288 79 0		237	71GD6	Grey/ PA	5148746	6288 61 5		335
7ZE	/ PA	5149460	6288 79 0		242						
7ZE	/ PA	5149460	6288 79 0		248	71GD7	Grey/ PA	5148685	6288 61 1		208
7ZE	/ PA	5149460	6288 79 0		253	71GD7	Grey/ PA	5148685	6288 61 1		211
7ZE	/ PA	5149460	6288 79 0		259	71GD7	Grey/ PA	5148685	6288 61 1		214
7ZE	/ PA	5149460	6288 79 0		266	71GD7	Grey/ PA	5148685	6288 61 1		220
7ZE	/ PA	5149460	6288 79 0		269	71GD7	Grey/ PA	5148685	6288 61 1		225
7ZE	/ PA	5149460	6288 79 0		272	71GD7	Grey/ PA	5148685	6288 61 1		230
7ZE	/ PA	5149460	6288 79 0		275	71GD7	Grey/ PA	5148685	6288 61 1		236
7ZE	/ PA	5149460	6288 79 0		278	71GD7	Grey/ PA	5148685	6288 61 1		241
7ZE	/ PA	5149460	6288 79 0		281	71GD7	Grey/ PA	5148685	6288 61 1		247
7ZE	/ PA	5149460	6288 79 0		284	71GD7	Grey/ PA	5148685	6288 61 1		252
7ZE	/ PA	5149460	6288 79 0		287	71GD7	Grey/ PA	5148685	6288 61 1		258
7ZE	/ PA	5149460	6288 79 0		290	71GD7	Grey/ PA	5148685	6288 61 1		266
7ZE	/ PA	5149460	6288 79 0		293	71GD7	Grey/ PA	5148685	6288 61 1		269
7ZE	/ PA	5149460	6288 79 0		296	71GD7	Grey/ PA	5148685	6288 61 1		272
7ZE	/ PA	5149460	6288 79 0		299	71GD7	Grey/ PA	5148685	6288 61 1		275
7ZE	/ PA	5149460	6288 79 0		338	71GD7	Grey/ PA	5148685	6288 61 1		278
						71GD7	Grey/ PA	5148685	6288 61 1		281
8AWR	/ St / G	5149101	6288 70 4		224	71GD7	Grey/ PA	5148685	6288 61 1		284
8AWR	/ St / G	5149101	6288 70 4		229	71GD7	Grey/ PA	5148685	6288 61 1		287
8AWR	/ St / G	5149101	6288 70 4		235	71GD7	Grey/ PA	5148685	6288 61 1		290
8AWR	/ St / G	5149101	6288 70 4		240	71GD7	Grey/ PA	5148685	6288 61 1		293
8AWR	/ St / G	5149101	6288 70 4		246	71GD7	Grey/ PA	5148685	6288 61 1		296
8AWR	/ St / G	5149101	6288 70 4		251	71GD7	Grey/ PA	5148685	6288 61 1		299
8AWR	/ St / G	5149101	6288 70 4		257	71GD7	Grey/ PA	5148685	6288 61 1		331
8AWR	/ St / G	5149101	6288 70 4		263	71GD7	Grey/ PA	5148685	6288 61 1		335
8VS4		5146797	6287 81 0		307	71GD8	Grey/ PA	5148562	6288 57 0		331
						71GD8	Grey/ PA	5148562	6288 57 0		335
71GD6	Grey/ PA	5148678	6288 61 0		208	71GD8	Grey/ PA	5148562	6288 57 0		338
71GD6	Grey/ PA	5148678	6288 61 0		211	71GD8	Grey/ PA	5148579	6288 57 1		331
71GD6	Grey/ PA	5148678	6288 61 0		214	71GD8	Grey/ PA	5148579	6288 57 1		335
71GD6	Grey/ PA	5148678	6288 61 0		220	71GD8	Grey/ PA	5148579	6288 57 1		338
71GD6	Grey/ PA	5148678	6288 61 0		225						
71GD6	Grey/ PA	5148678	6288 61 0		230	71GD9	Grey/ PA	5148586	6288 58 0		331
71GD6	Grey/ PA	5148678	6288 61 0		236	71GD9	Grey/ PA	5148586	6288 58 0		335
71GD6	Grey/ PA	5148678	6288 61 0		241	71GD9	Grey/ PA	5148586	6288 58 0		338
71GD6	Grey/ PA	5148678	6288 61 0		247	71GD9	Grey/ PA	5148593	6288 58 1		331
71GD6	Grey/ PA	5148678	6288 61 0		252	71GD9	Grey/ PA	5148593	6288 58 1		335
71GD6	Grey/ PA	5148678	6288 61 0		258	71GD9	Grey/ PA	5148593	6288 58 1		338
71GD6	Grey/ PA	5148678	6288 61 0		266						
71GD6	Grey/ PA	5148678	6288 61 0		269						
71GD6	Grey/ PA	5148678	6288 61 0		272	71MT3 45	Grey/ PA	5480969	6288 57 5		338
71GD6	Grey/ PA	5148678	6288 61 0		275						
71GD6	Grey/ PA	5148678	6288 61 0		278						
71GD6	Grey/ PA	5148678	6288 61 0		281						
71GD6	Grey/ PA	5148678	6288 61 0		284	910 SD 6X35	6 35/ PA	5669197	2351 05 6	/100 pc.	125
71GD6	Grey/ PA	5148678	6288 61 0		287						
71GD6	Grey/ PA	5148678	6288 61 0		290						
71GD6	Grey/ PA	5148678	6288 61 0		293	2064 GTP 2M	1,5/ ST / GTP	5044291	1115 05 7	/100 m	185
71GD6	Grey/ PA	5148678	6288 61 0		296	2064 GTPL 2M	1,5/ ST / GTP	5044352	1115 06 5		185
71GD6	Grey/ PA	5148678	6288 61 0		299						
71GD6	Grey/ PA	5148678	6288 61 0		331	2069 2M GTP	1/ St / GTP	5045434	1115 65 0		185
71GD6	Grey/ PA	5148678	6288 61 0		335	2069 2M GTPL	1/ ST / GTP	5045496	1115 66 9		185
71GD6	Grey/ PA	5148746	6288 61 5		208						
71GD6	Grey/ PA	5148746	6288 61 5		211						
71GD6	Grey/ PA	5148746	6288 61 5		214						
71GD6	Grey/ PA	5148746	6288 61 5		220	2370 110	Stone grey 95,7/ PVC	6026173	6023 51 7	/100 pc.	121
71GD6	Grey/ PA	5148746	6288 61 5		225						
71GD6	Grey/ PA	5148746	6288 61 5		230	2370 130	Stone grey 116,2/ PVC	6026234	6023 52 5		121
71GD6	Grey/ PA	5148746	6288 61 5		236						
71GD6	Grey/ PA	5148746	6288 61 5		241	2370 150	Stone grey 136,2/ PVC	6637874	6023 53 3		121
71GD6	Grey/ PA	5148746	6288 61 5		247						
71GD6	Grey/ PA	5148746	6288 61 5		252	2370 170	Stone grey 156,7/ PVC	6026296	6023 54 1		121

06 LFS_Katalog_2010_Neuer_Stand / en / 22/02/2010 (LLExport_00995)

Type	Dimensions/Colour/Div.	EAN-C.	Art. no.	Price	Page	Type	Dimensions/Colour/Div.	EAN-C.	Art. no.	Price	Page
2370 210	Stone grey 197,2/ PVC	6026357	6023 57 6	/100 pc.	121	ANT-2D AL1	Aluminium paint	5675181	6117 39 1	/pc.	347
2370 230	Stone grey 216,2/ PVC	6639250	6023 58 4		122	ANT-2D RW1	Pure white	5675167	6117 38 7		347
2370 60	Stone grey 48,8/ PVC	6023776	6022 99 5		121	ANT-2D SWGR1	Black-grey	5675174	6117 38 9		347
2370 90	Stone grey 75,7/ PVC	6026111	6023 50 9		121	ANT-2E AL1	Aluminium paint	5675150	6117 38 5		347
2371 100	Light grey 2000/ PVC	6030736	6026 99 0	/m	122	ANT-2E RW1	Pure white	5675112	6117 38 1		347
2371 40	Light grey 2000/ PVC	6024315	6023 09 6		122	ANT-2E SWGR1	Black-grey	5675129	6117 38 3		347
2371 40	Light grey 2000/ PVC	6024315	6023 09 6		188	ANT-3E AL1	Aluminium paint	5675235	6117 39 7		347
2371 40	Light grey 2000/ PVC	6024315	6023 09 6		191	ANT-3E RW1	Pure white	5675211	6117 39 3		347
2371 40	Light grey 2000/ PVC	6024315	6023 09 6		200	ANT-3E SWGR1	Black-grey	5675228	6117 39 5		347
2371 40	Light grey 2000/ PVC	6024315	6023 09 6		203						
2371 60	Light grey 2000/ PVC	6024377	6023 11 8		122	AO3VA50EL	/ Al / EL	5157724	6287 23 3		291
2371 80	Light grey 2000/ PVC	6030675	6026 98 2		122	AO3VA50EL	/ Al / EL	5157724	6287 23 3		294
2390	Light grey/ PVC	6024919	6023 20 7	/pc.	122	AO3VA50RW	Pure white/ Al	5157687	6287 23 0		291
2392	Light grey/ PA/GF	6027132	6024 00 9		124	AO3VA50RW	Pure white/ Al	5157687	6287 23 0		294
2393 16	Stone grey 110/ PVC	6027255	6024 02 5		125	AO3VA80EL	/ Al / EL	5145257	6287 20 3		267
2393 32	Stone grey 110/ PVC	6027316	6024 03 3		125	AO3VA80EL	/ Al / EL	5145257	6287 20 3		270
2410 110GR	Stone grey 2000/ PVC	6023295	6022 71 5	/m	126	AO3VA80EL	/ Al / EL	5145257	6287 20 3		273
2410 110LGR	Light grey 2000/ PVC	6669257	6028 15 2		126	AO3VA80EL	/ Al / EL	5145257	6287 20 3		276
2410 170GR	Stone grey 2000/ PVC	6023417	6022 75 8		126	AO3VA80EL	/ Al / EL	5145257	6287 20 3		279
2410 170LGR	Light grey 2000/ PVC	6773893	6028 18 7		126	AO3VA80EL	/ Al / EL	5145257	6287 20 3		282
2425 150CW	Cream 300/ PVC	6782659	6168 52 3	/pc.	125	AO3VA80EL	/ Al / EL	5145257	6287 20 3		285
2425 150RW	Pure white 300/ PVC	6629350	6194 72 9		125	AO3VA80EL	/ Al / EL	5145257	6287 20 3		288
2650	Stone grey 2000/ PVC	6362530	6020 80 1	/m	161	AO3VA80RW	Pure white/ Al	5145240	6287 20 0		291
AD-90G M45	/ St	5469148	6258 14 1	/pc.	346	AO3VA80RW	Pure white/ Al	5145240	6287 20 0		294
ADP-B AL0.5	Aluminium paint	6215652	6117 41 6		348	AO3VA80RW	Pure white/ Al	5145240	6287 20 0		297
ADP-B AL1	Aluminium paint	6214037	6117 40 8		348	AO3VA80RW	Pure white/ Al	5145240	6287 20 0		300
ADP-B RW0.5	Pure white	6117550	6117 41 4		348	AS-B AL0.5	Aluminium paint	5275688	6117 62 1		344
ADP-B RW1	Pure white	6117499	6117 40 6		348	AS-B RW0.5	Pure white	5275640	6117 62 0		344
ADP-B SWGR0.5	Black-grey	5701286	6117 41 5		348	AS-B SWGR0.5	Black-grey	5701019	6117 62 2		344
ADP-B SWGR1	Black-grey	5701279	6117 40 7		348	AS-B2P AL1	Aluminium paint	5275886	6117 64 5		345
ADR-80 1 AL	Aluminium paint/ PC	6279739	6258 07 1		355	AS-B2P RW1	Pure white	5275879	6117 64 4		345
ADR-80 1 RW	Pure white/ PC	6043156	6258 06 9		355	AS-B2P SWGR1	Black-grey	5701088	6117 64 3		345
AH1	Grey 12/ PVC	6014873	6178 54 0	/100 pc.	185	ASM-C5		6235278	6117 33 7		348
AH2	Grey 20/ PVC	6014996	6178 54 2		185	ASM-C5 G		6235155	6117 32 5		348
AKZ	/ ST	6014750	6178 53 5	/pc.	184	ASM-C6		6235339	6117 34 1		348
ANT-1S AL0.5	Aluminium paint	5406235	6117 60 7		347	ASM-C6 G		6235216	6117 32 9		349
ANT-1S RW0.5	Pure white	5406204	6117 60 6		347	ASM-LWL K		6237319	6117 74 0		349
ANT-1S SWGR0.5	Black-grey	5701316	6117 61 0		347	BKN120 205	/ St / FS	5676195	6288 00 5		304
						BKN200 350	/ St / FS	5676201	6288 00 7		304

Type listing

Structure of the EAN number: Country code 40

Manufacturer code 1219 (for articles beginning with 0: 1010)

Individual EAN-C 5647589

Type	Dimensions/Colour/Div.	EAN-C.	Art. no.	Price	Page	Type	Dimensions/Colour/Div.	EAN-C.	Art. no.	Price	Page
BKN50 80	/ St / FS	5676140	6288 00 1	/pc.	304	DMG-1RM SWGR0.5	Black-grey	5701163	6117 29 1	/pc.	349
BKN75 125	/ St / FS	5676188	6288 00 3		304						
BTA-SKS S1 SW	Black	5438069	6117 19 0		344	DMG-2RM AL1	Aluminium paint	5006961	6117 32 0		349
BTA-SKS S1 W	White	5483540	6117 19 1		344	DMG-2RM RW1	Pure white	5006947	6117 31 9		349
BVB125	/ ST	5146766	6287 80 0		307	DMG-2RM SWGR1	Black-grey	5701200	6117 31 8		349
BVL		5147404	6288 18 0		306	DMS-2RM AL1	Aluminium paint/ PC	5006886	6117 31 6		349
CEE16E2	Grey/ PA	5148715	6288 61 2		356	DMS-2RM RW1	Pure white/ PC	5006848	6117 31 5		349
CEE32E2	Grey/ PA	5148739	6288 61 4		357	DMS-2RM SWGR1	Black-grey/ PC	5701194	6117 31 4		349
CPK-C5SF UTP10	Grey	5008569	6117 94 2		351	DMZ-AVS GN	Green	6239054	6117 72 4		350
CPK-C5SF UTP15	Grey	5008620	6117 94 4		351	DMZ-AVS RO	Red	6239351	6117 72 6		350
CPK-C5SF UTP2	Grey	5081005	6117 93 8		351	DMZ-AVS W	White	6239474	6117 72 8		350
CPK-C5SF UTP7.5	Grey	5008521	6117 94 0		351	DMZ-ES AVS	Black	6239658	6117 74 5		350
CPK-C6S FTP10	Grey	5008682	6117 95 0		351	DMZ-ESMV CB	White	6237913	6117 70 8		350
CPK-C6S FTP15	Grey	5008743	6117 95 2		351						
CPK-C6S FTP2	Grey	5081401	6117 94 6		351	DMZ-RR RJ11	Green	5677819	6117 97 2		349
CPK-C6S FTP7.5	Grey	5008644	6117 94 8		351						
CST-SKS	Black/ PC	5364610	6106 73 5		342	DMZ-SC GN	Green	5008767	6117 95 7		350
D2-1 110CW	Cream 300/ PVC	6111619	6169 30 9		122	DMZ-SC RO	Red	5008804	6117 95 8		350
D2-1 110RW	Pure white 300/ PVC	6448272	6194 03 6		122	DMZ-SCHL AVS	Yellow	6239535	6117 73 2		350
D2-1 130CW	Cream 300/ PVC	6111671	6169 31 7		123	DMZ-STG GN	Green	5007562	6117 73 7		350
D2-1 130RW	Pure white 300/ PVC	6448098	6194 04 4		123	DMZ-STG RO	Red	5007609	6117 73 8		350
D2-1 150CW	Cream 300/ PVC	6781393	6169 29 5		123	DMZ-STG W	White	6239597	6117 73 6		350
D2-1 150RW	Pure white 300/ PVC	6447978	6194 05 2		123	DTG-2A AL1	Aluminium paint/ pc	5696940	6119 20 6		351
D2-1 170CW	Cream 300/ PVC	6111732	6169 32 5		124	DTG-2A RW1	Pure white/ pc	5696896	6119 20 2		351
D2-1 170RW	Pure white 300/ PVC	6447497	6194 06 0		124	DTG-2A SWGR1	Black-grey/ pc	5696902	6119 20 4		351
D2-2 110CW	Cream 300/ PVC	6111855	6169 37 6		123	DTG-2B AL1	Aluminium paint/ pc	5696971	6119 21 2		352
D2-2 110GR	Stone grey 300/ PVC	6103997	6159 37 0		123	DTG-2B RW1	Pure white/ pc	5696957	6119 20 8		352
D2-2 110RW	Pure white 300/ PVC	6628636	6194 10 9		123	DTG-2B SWGR1	Black-grey/ pc	5696964	6119 21 0		352
D2-2 130CW	Cream 300/ PVC	6111916	6169 38 4		123	DTG-2C AL1	Aluminium paint/ pc	5697008	6119 21 8		352
D2-2 130RW	Pure white 300/ PVC	6628575	6194 11 7		123	DTG-2C RW1	Pure white/ pc	5696988	6119 21 4		352
D2-2 150CW	Cream 300/ PVC	6782291	6169 36 8		123	DTG-2C SWGR1	Black-grey/ pc	5696995	6119 21 6		352
D2-2 150RW	Pure white 300/ PVC	6628513	6194 12 5		123	DTG-2EP AL1	Aluminium paint/ pc	5697121	6119 23 6		352
D2-2 170CW	Cream 300/ PVC	6111978	6169 39 2		124	DTG-2EP RW1	Pure white/ pc	5697077	6119 23 2		352
D2-2 170RW	Pure white 300/ PVC	6628452	6194 13 3		124	DTG-2EP SWGR1	Black-grey/ pc	5697084	6119 23 4		352
D2-2 210CW	Cream 300/ PVC	6112036	6169 40 6		124	DTG-2F AL1	Aluminium paint/ pc	5697039	6119 22 4		353
D2-2 210RW	Pure white 300/ PVC	6628391	6194 14 1		124	DTG-2F RW1	Pure white/ pc	5697015	6119 22 0		353
D2-3 110CW	Cream 300/ PVC	6112098	6169 43 0		123	DTG-2F SWGR1	Black-grey/ pc	5697022	6119 22 2		353
D2-3 110RW	Pure white 300/ PVC	6628339	6194 18 4		123	DTG-2PA AL1	Aluminium paint/ pc	5697060	6119 23 0		353
D2-3 130CW	Cream 300/ PVC	6112159	6169 44 9		123	DTG-2PA RW1	Pure white/ pc	5697046	6119 22 6		353
D2-3 130RW	Pure white 300/ PVC	6618910	6194 19 2		123	DTG-2PA SWGR1	Black-grey/ pc	5697053	6119 22 8		353
D2-3 150CW	Cream 300/ PVC	6782475	6169 42 2		124	DTS-2A AL1	Aluminium paint/ pc	5697183	6119 24 2		351
D2-3 150RW	Pure white 300/ PVC	6618859	6194 20 6		124	DTS-2A RW1	Pure white/ pc	5697138	6119 23 8		351
D2-3 170CW	Cream 300/ PVC	6112210	6169 45 7		124	DTS-2A SWGR1	Black-grey/ pc	5697145	6119 24 0		351
D2-3 170RW	Pure white 300/ PVC	6349814	6194 21 4		124	DTS-2B AL1	Aluminium paint/ pc	5697244	6119 24 8		352
DAB-F	Pure white/ St	5448792	6290 26 9		327	DTS-2B RW1	Pure white/ pc	5697190	6119 24 4		352
DAB-F	Pure white/ St	5448792	6290 26 9		328	DTS-2B SWGR1	Black-grey/ pc	5697206	6119 24 6		352
DAB-F	Pure white/ St	5448792	6290 26 9		330						
DMG-1RM AL0.5	Aluminium paint	5006725	6117 29 3		349						
DMG-1RM RW0.5	Pure white	6233410	6117 29 2		349						

06 LFS_Katalog_2010_Neuer_Stand / en / 22/02/2010 (LLExport_00995)

Type	Dimensions/Colour/Div.	EAN-C.	Art. no.	Price	Page	Type	Dimensions/Colour/Div.	EAN-C.	Art. no.	Price	Page
DTS-2C AL1	Aluminium paint/ pc	5697305	6119 25 4	/pc.	352	G-AWAG90210LGR	Light grey 278/ AI	5667612	6279 05 2	/pc.	312
DTS-2C RW1	Pure white/ pc	5697251	6119 25 0		352	G-AWAG90210RW	Pure white 278/ AI	5667599	6279 05 0		312
DTS-2C SWGR1	Black-grey/ pc	5697268	6119 25 2		352	G-AWAO70110CW	Cream 178/ AI	5666592	6278 80 1		310
DTS-2EP AL1	Aluminium paint/ pc	5697497	6119 27 2		353	G-AWAO70110LGR	Light grey 178/ AI	5666608	6278 80 2		310
DTS-2EP RW1	Pure white/ pc	5697442	6119 26 8		353	G-AWAO70110RW	Pure white 178/ AI	5666585	6278 80 0		310
DTS-2EP SWGR1	Black-grey/ pc	5697480	6119 27 0		353	G-AWAO70130CW	Cream 198/ AI	5666707	6278 81 1		310
DTS-2PA AL1	Aluminium paint/ pc	5697435	6119 26 6		353	G-AWAO70130LGR	Light grey 198/ AI	5666714	6278 81 2		310
DTS-2PA RW1	Pure white/ pc	5697381	6119 26 2		353	G-AWAO70130RW	Pure white 198/ AI	5666660	6278 81 0		310
DTS-2PA SWGR1	Black-grey/ pc	5697428	6119 26 4		353	G-AWAO70170CW	Cream 238/ AI	5666783	6278 82 1		311
EDA45	Yellow green 400/ Cu	5030898	6257 59 8		200	G-AWAO70170LGR	Light grey 238/ AI	5666820	6278 82 2		311
EDA45	Yellow green 400/ Cu	5030898	6257 59 8		203	G-AWAO70170RW	Pure white 238/ AI	5666776	6278 82 0		311
EDAKL	/ St / G	6800711	6257 60 3		200	G-AWAO70210CW	Cream 278/ AI	5666882	6278 83 1		311
EDAKL	/ St / G	6800711	6257 60 3		203	G-AWAO70210LGR	Light grey 278/ AI	5666899	6278 83 2		311
EK300CW	Cream 850/ ST / FS	5126522	6246 05 2		313	G-AWAO70210RW	Pure white 278/ AI	5666875	6278 83 0		311
EK300RW	Pure white 850/ ST / FS	5126539	6246 08 7		313	G-AWAO90110CW	Cream 178/ AI	5667179	6278 88 1		310
FO3VEL	/ AI / EL	5145295	6287 21 3		267	G-AWAO90110LGR	Light grey 178/ AI	5667186	6278 88 2		310
FO3VEL	/ AI / EL	5145295	6287 21 3		270	G-AWAO90110RW	Pure white 178/ AI	5667148	6278 88 0		310
FO3VEL	/ AI / EL	5145295	6287 21 3		273	G-AWAO90130CW	Cream 198/ AI	5667223	6278 89 1		310
FO3VEL	/ AI / EL	5145295	6287 21 3		276	G-AWAO90130LGR	Light grey 198/ AI	5667230	6278 89 2		310
FO3VEL	/ AI / EL	5145295	6287 21 3		279	G-AWAO90130RW	Pure white 198/ AI	5667216	6278 89 0		310
FO3VEL	/ AI / EL	5145295	6287 21 3		282	G-AWAO90170CW	Cream 238/ AI	5667278	6279 00 1		311
FO3VEL	/ AI / EL	5145295	6287 21 3		285	G-AWAO90170LGR	Light grey 238/ AI	5667285	6279 00 2		311
FO3VEL	/ AI / EL	5145295	6287 21 3		288	G-AWAO90170RW	Pure white 238/ AI	5667261	6279 00 0		311
FO3VEL	/ AI / EL	5145295	6287 21 3		292	G-AWAO90210CW	Cream 278/ AI	5667322	6279 01 1		311
FO3VEL	/ AI / EL	5145295	6287 21 3		295	G-AWAO90210LGR	Light grey 278/ AI	5667353	6279 01 2		311
FO3VEL	/ AI / EL	5145295	6287 21 3		297	G-AWAO90210RW	Pure white 278/ AI	5667315	6279 01 0		311
FO3VEL	/ AI / EL	5145295	6287 21 3		300	GEK-A100213DEL	/ AI / EL	5142379	6285 30 3	/m	299
FO3VRW	Pure white/ AI	5145264	6287 21 0		267	GEK-A100213DRW	Pure white/ AI / FS	5142362	6285 30 0		299
FO3VRW	Pure white/ AI	5145264	6287 21 0		270	GEK-A53100EL	Aluminium/ AI / EL	6198252	6116 51 5		200
FO3VRW	Pure white/ AI	5145264	6287 21 0		273	GEK-A53160EL	Aluminium/ AI / EL	6204199	6116 53 6		203
FO3VRW	Pure white/ AI	5145264	6287 21 0		276	GEK-A70110EL	/ AI / EL	5157076	6285 40 3		266
FO3VRW	Pure white/ AI	5145264	6287 21 0		279	GEK-A70110RW	Pure white/ AI / FS	5157069	6285 40 0		266
FO3VRW	Pure white/ AI	5145264	6287 21 0		282	GEK-A70133EL	/ AI / EL	5140887	6284 40 3		272
FO3VRW	Pure white/ AI	5145264	6287 21 0		285	GEK-A70133RW	Pure white/ AI / FS	5140870	6284 40 0		272
FO3VRW	Pure white/ AI	5145264	6287 21 0		288	GEK-A70213DEL	/ AI / EL	5142171	6285 20 3		296
FO3VRW	Pure white/ AI	5145264	6287 21 0		292	GEK-A70213DRW	Pure white/ AI / FS	5142140	6285 20 0		296
FO3VRW	Pure white/ AI	5145264	6287 21 0		295	GEK-A90110EL	/ AI / EL	5157366	6285 50 3		269
FO3VRW	Pure white/ AI	5145264	6287 21 0		297	GEK-A90110RW	Pure white/ AI / FS	5157328	6285 50 0		269
FO3VRW	Pure white/ AI	5145264	6287 21 0		299	GEK-A90133EL	/ AI / EL	5141112	6284 50 3		275
FO3VRW	Pure white/ AI	5145264	6287 21 0		300	GEK-A90133RW	Pure white/ AI / FS	5141105	6284 50 0		275
G-AWAG70110CW	Cream 178/ AI	5666936	6278 84 1		311	GEK-AA100213DEL	/ AI / EL	5142416	6285 31 3	/pc.	300
G-AWAG70110LGR	Light grey 178/ AI	5666943	6278 84 2		311	GEK-AA100213DRW	Pure white/ AI / FS	5142386	6285 31 0		300
G-AWAG70110RW	Pure white 178/ AI	5666929	6278 84 0		311	GEK-AA53100	Aluminium/ AI / EL	6210251	6116 61 7		202
G-AWAG70130CW	Cream 198/ AI	5666981	6278 85 1		312	GEK-AA53160	Aluminium/ AI / EL	6210558	6116 64 7		205
G-AWAG70130LGR	Light grey 198/ AI	5666998	6278 85 2		312	GEK-AA70110EL	/ AI / EL	5157120	6285 41 3		267
G-AWAG70130RW	Pure white 198/ AI	5666974	6278 85 0		312	GEK-AA70110RW	Pure white/ AI / FS	5157083	6285 41 0		267
G-AWAG70170CW	Cream 238/ AI	5667056	6278 86 1		312	GEK-AA70133EL	/ AI / EL	5140924	6284 41 3		273
G-AWAG70170LGR	Light grey 238/ AI	5667063	6278 86 2		312	GEK-AA70133RW	Pure white/ AI / FS	5140917	6284 41 0		273
G-AWAG70170RW	Pure white 238/ AI	5667025	6278 86 0		312	GEK-AA70173DEL	/ AI / EL	5156598	6285 00 3	/m	290
G-AWAG70210CW	Cream 278/ AI	5667100	6278 87 1		312	GEK-AA70173DRW	Pure white/ AI / FS	5156581	6285 00 0		290
G-AWAG70210LGR	Light grey 278/ AI	5667117	6278 87 2		312	GEK-AA70173EL	/ AI / EL	5141334	6284 60 3		278
G-AWAG70210RW	Pure white 278/ AI	5667094	6278 87 0		312	GEK-AA70173RW	Pure white/ AI / FS	5141303	6284 60 0		278
G-AWAG90110CW	Cream 178/ AI	5667414	6279 02 1		311	GEK-AA70213DEL	/ AI / EL	5142195	6285 21 3	/pc.	297
G-AWAG90110LGR	Light grey 178/ AI	5667421	6279 02 2		311	GEK-AA70213DRW	Pure white/ AI / FS	5142188	6285 21 0		297
G-AWAG90110RW	Pure white 178/ AI	5667384	6279 02 0		311	GEK-AA70213EL	/ AI / EL	5141754	6284 80 3	/m	284
G-AWAG90130CW	Cream 198/ AI	5667483	6279 03 1		312	GEK-AA70213RW	Pure white/ AI / FS	5141723	6284 80 0		284
G-AWAG90130LGR	Light grey 198/ AI	5667490	6279 03 2		312	GEK-AA90110EL	/ AI / EL	5157380	6285 51 3	/pc.	270
G-AWAG90130RW	Pure white 198/ AI	5667476	6279 03 0		312	GEK-AA90110RW	Pure white/ AI / FS	5157373	6285 51 0		270
G-AWAG90170CW	Cream 238/ AI	5667537	6279 04 1		312	GEK-AA90133EL	/ AI / EL	5141150	6284 51 3		276
G-AWAG90170LGR	Light grey 238/ AI	5667544	6279 04 2		312	GEK-AA90133RW	Pure white/ AI / FS	5141129	6284 51 0		276
G-AWAG90170RW	Pure white 238/ AI	5667520	6279 04 0		312	GEK-AA90173DEL	/ AI / EL	5156833	6285 10 3	/m	293
G-AWAG90210CW	Cream 278/ AI	5667605	6279 05 1		312	GEK-AA90173DRW	Pure white/ AI / FS	5156826	6285 10 0		293

Type listing

Structure of the EAN number: Country code **40**

Manufacturer code **1219** (for articles beginning with **0: 1010**)

Individual EAN-C **5647589**

Type	Dimensions/Colour/Div.	EAN-C.	Art. no.	Price	Page	Type	Dimensions/Colour/Div.	EAN-C.	Art. no.	Price	Page
GEK-AA90173EL	/ AI / EL	5141532	6284 70 3	/m	281	GEK-AAT70213RW	Pure white / AI / FS	5141884	6284 86 0	/pc.	285
GEK-AA90173RW	Pure white / AI / FS	5141525	6284 70 0		281						
GEK-AA90213EL	/ AI / EL	5141952	6284 90 3		287	GEK-AAT90173DEL	/ AI / EL	5157021	6285 16 3		295
GEK-AA90213RW	Pure white / AI / FS	5141945	6284 90 0		287	GEK-AAT90173DRW	Pure white / AI / FS	5157014	6285 16 0		295
						GEK-AAT90173EL	/ AI / EL	5141693	6284 76 3		282
				/pc.		GEK-AAT90173RW	Pure white / AI / FS	5141662	6284 76 0		282
GEK-AAA70173DEL	/ AI / EL	5156642	6285 01 3		291	GEK-AAT90213EL	/ AI / EL	5142119	6284 96 3		288
GEK-AAA70173DRW	Pure white / AI / FS	5156604	6285 01 0		291	GEK-AAT90213RW	Pure white / AI / FS	5142089	6284 96 0		288
GEK-AAA70173EL	/ AI / EL	5141358	6284 61 3		279						
GEK-AAA70173RW	Pure white / AI / FS	5141341	6284 61 0		279	GEK-AE70110EL	/ AI / EL	5157311	6285 47 3		268
GEK-AAA70213EL	/ AI / EL	5141778	6284 81 3		285	GEK-AE70110RW	Pure white / AI / FS	5157304	6285 47 0		268
GEK-AAA70213RW	Pure white / AI / FS	5141761	6284 81 0		285	GEK-AE70133EL	/ AI / EL	5141099	6284 47 3		274
						GEK-AE70133RW	Pure white / AI / FS	5141068	6284 47 0		274
GEK-AA90173DEL	/ AI / EL	5156888	6285 11 3		294						
GEK-AA90173DRW	Pure white / AI / FS	5156840	6285 11 0		294	GEK-AE90110EL	/ AI / EL	5157601	6285 57 3		271
GEK-AA90213EL	/ AI / EL	5141990	6284 91 3		288	GEK-AE90110RW	Pure white / AI / FS	5157564	6285 57 0		271
GEK-AA90213RW	Pure white / AI / FS	5141969	6284 91 0		288	GEK-AE901EL	/ AI / EL	5141297	6284 57 3		277
GEK-AA90EL	/ AI / EL	5141570	6284 71 3		282	GEK-AE901RW	Pure white / AI / FS	5141280	6284 57 0		277
GEK-AA90RW	Pure white / AI / FS	5141549	6284 71 0		282						
						GEK-AFF100213DEL	/ AI / EL	5142478	6285 33 3		300
GEK-AAE100213DEL	/ AI / EL	5142553	6285 37 3		301	GEK-AFF100213DRW	Pure white / AI / FS	5142447	6285 33 0		300
GEK-AAE100213DRW	Pure white / AI / FS	5142546	6285 37 0		301						
						GEK-AFF53100	Aluminium / AI / EL	6211272	6116 70 9		201
GEK-AAE70173EL	/ AI / EL	5141518	6284 67 3		280	GEK-AFF53160	Aluminium / AI / EL	6211395	6116 73 6		204
GEK-AAE70173EL	/ AI / EL	5141518	6284 67 3		292						
GEK-AAE70173RW	Pure white / AI / FS	5141488	6284 67 0		280	GEK-AFF70110EL	/ AI / EL	5157199	6285 43 3		267
GEK-AAE70173RW	Pure white / AI / FS	5141488	6284 67 0		292	GEK-AFF70110RW	Pure white / AI / FS	5157182	6285 43 0		267
GEK-AAE70213DEL	/ AI / EL	5142355	6285 27 3		298	GEK-AFF70133EL	/ AI / EL	5140986	6284 43 3		273
GEK-AAE70213DRW	Pure white / AI / FS	5142324	6285 27 0		298	GEK-AFF70133RW	Pure white / AI / FS	5140979	6284 43 0		273
GEK-AAE70213EL	/ AI / EL	5141938	6284 87 3		286	GEK-AFF70213DEL	/ AI / EL	5142256	6285 23 3		297
GEK-AAE70213RW	Pure white / AI / FS	5141907	6284 87 0		286	GEK-AFF70213DRW	Pure white / AI / FS	5142249	6285 23 0		297
GEK-AAE90173EL	/ AI / EL	5141716	6284 77 3		283	GEK-AFF90110EL	/ AI / EL	5157489	6285 53 3		270
GEK-AAE90173EL	/ AI / EL	5141716	6284 77 3		295	GEK-AFF90110RW	Pure white / AI / FS	5157441	6285 53 0		270
GEK-AAE90173RW	Pure white / AI / FS	5141709	6284 77 0		283	GEK-AFF90133EL	/ AI / EL	5141211	6284 53 3		276
GEK-AAE90173RW	Pure white / AI / FS	5141709	6284 77 0		295	GEK-AFF90133RW	Pure white / AI / FS	5141181	6284 53 0		276
GEK-AAE90213EL	/ AI / EL	5142133	6284 97 3		289						
GEK-AAE90213RW	Pure white / AI / FS	5142126	6284 97 0		289	GEK-AFS100213DEL	/ AI / EL	5142430	6285 32 3		300
						GEK-AFS100213DRW	Pure white / AI / FS	5142423	6285 32 0		300
GEK-AAFF70173DEL	/ AI / EL	5156710	6285 03 3		291	GEK-AFS53100	Aluminium / AI / EL	6210671	6116 66 8		201
GEK-AAFF70173DRW	Pure white / AI / FS	5156703	6285 03 0		291	GEK-AFS53160	Aluminium / AI / EL	6210978	6116 68 5		204
GEK-AAFF70213EL	/ AI / EL	5141839	6284 83 3		285						
GEK-AAFF70213RW	Pure white / AI / FS	5141822	6284 83 0		285	GEK-AFS70110EL	/ AI / EL	5157144	6285 42 3		267
GEK-AAFF7EL	/ AI / EL	5141419	6284 63 3		279	GEK-AFS70110RW	Pure white / AI / FS	5157137	6285 42 0		267
GEK-AAFF7RW	Pure white / AI / FS	5141402	6284 63 0		279	GEK-AFS70133EL	/ AI / EL	5140948	6284 42 3		273
GEK-AAFF90173DEL	/ AI / EL	5156956	6285 13 3		294	GEK-AFS70133RW	Pure white / AI / FS	5140931	6284 42 0		273
GEK-AAFF90173DRW	Pure white / AI / FS	5156949	6285 13 0		294	GEK-AFS70213DEL	/ AI / EL	5142232	6285 22 3		297
GEK-AAFF90173EL	/ AI / EL	5141631	6284 73 3		282	GEK-AFS70213DRW	Pure white / AI / FS	5142201	6285 22 0		297
GEK-AAFF90173RW	Pure white / AI / FS	5141600	6284 73 0		282						
GEK-AAFF90213EL	/ AI / EL	5142058	6284 93 3		288	GEK-AFS90110EL	/ AI / EL	5157434	6285 52 3		270
GEK-AAFF90213RW	Pure white / AI / FS	5142027	6284 93 0		288	GEK-AFS90110RW	Pure white / AI / FS	5157427	6285 52 0		270
						GEK-AFS90133EL	/ AI / EL	5141174	6284 52 3		276
GEK-AAFS70173DEL	/ AI / EL	5156666	6285 02 3		291	GEK-AFS90133RW	Pure white / AI / FS	5141167	6284 52 0		276
GEK-AAFS70173DRW	Pure white / AI / FS	5156659	6285 02 0		291						
GEK-AAFS70173EL	/ AI / EL	5141396	6284 62 3		279	GEK-AI53100	Aluminium / AI / EL	6210015	6116 57 9		201
GEK-AAFS70173RW	Pure white / AI / FS	5141365	6284 62 0		279	GEK-AI53160	Aluminium / AI / EL	6210138	6116 59 5		204
GEK-AAFS70213EL	/ AI / EL	5141815	6284 82 3		285						
GEK-AAFS70213RW	Pure white / AI / FS	5141785	6284 82 0		285	GEK-AI90110EL	/ AI / EL	5157502	6285 54 3		270
GEK-AAFS90173DEL	/ AI / EL	5156901	6285 12 3		294	GEK-AI90110RW	Pure white / AI / FS	5157496	6285 54 0		270
GEK-AAFS90173DRW	Pure white / AI / FS	5156895	6285 12 0		294						
GEK-AAFS90173EL	/ AI / EL	5141594	6284 72 3		282	GEK-AIA70173DEL	/ AI / EL	5156765	6285 04 3		292
GEK-AAFS90173RW	Pure white / AI / FS	5141587	6284 72 0		282	GEK-AIA70173DRW	Pure white / AI / FS	5156727	6285 04 0		292
GEK-AAFS90213EL	/ AI / EL	5142010	6284 92 3		288	GEK-AIA70EL	/ AI / EL	5157243	6285 44 3		267
GEK-AAFS90213RW	Pure white / AI / FS	5142003	6284 92 0		288	GEK-AIA70RW	Pure white / AI / FS	5157205	6285 44 0		267
GEK-AAIS70173EL	/ AI / EL	5141457	6284 64 3		279	GEK-AIA90173DEL	/ AI / EL	5157007	6285 14 3		295
GEK-AAIS70173RW	Pure white / AI / FS	5141426	6284 64 0		279	GEK-AIA90173DRW	Pure white / AI / FS	5156963	6285 14 0		295
GEK-AAIS70213EL	/ AI / EL	5141877	6284 84 3		285						
GEK-AAIS70213RW	Pure white / AI / FS	5141846	6284 84 0		285	GEK-AIS100213DEL	/ AI / EL	5142492	6285 34 3		300
GEK-AAIS90173EL	/ AI / EL	5141655	6284 74 3		282	GEK-AIS100213DRW	Pure white / AI / FS	5142485	6285 34 0		300
GEK-AAIS90173RW	Pure white / AI / FS	5141648	6284 74 0		282						
GEK-AAIS90213EL	/ AI / EL	5142072	6284 94 3		288	GEK-AIS70133EL	/ AI / EL	5141006	6284 44 3		273
GEK-AAIS90213RW	Pure white / AI / FS	5142065	6284 94 0		288	GEK-AIS70133RW	Pure white / AI / FS	5140993	6284 44 0		273
						GEK-AIS70213DEL	/ AI / EL	5142294	6285 24 3		297
GEK-AAT70173DEL	/ AI / EL	5156789	6285 06 3		292	GEK-AIS70213DRW	Pure white / AI / FS	5142263	6285 24 0		297
GEK-AAT70173DRW	Pure white / AI / FS	5156772	6285 06 0		292						
GEK-AAT70173EL	/ AI / EL	5141471	6284 66 3		279	GEK-AIS90133EL	/ AI / EL	5141235	6284 54 3		276
GEK-AAT70173RW	Pure white / AI / FS	5141464	6284 66 0		279	GEK-AIS90133RW	Pure white / AI / FS	5141228	6284 54 0		276
GEK-AAT70213EL	/ AI / EL	5141891	6284 86 3		285						

06_LFS_Katalog_2010_Neuer_Stand / en / 22/02/2010 (LLEXP00995)

Type	Dimensions/Colour/Div.	EAN-C.	Art. no.	Price	Page	Type	Dimensions/Colour/Div.	EAN-C.	Art. no.	Price	Page
GEK-AKU45	/ ST	6211456	6116 75 2	/pc.	200	GEK-KS45	Pure white/ PVC	6441259	6116 15 0	/pc.	188
GEK-AKU45	/ ST	6211456	6116 75 2		203	GEK-KS45	Pure white/ PVC	6441259	6116 15 0		191
						GEK-KS45	Aluminium/ PVC	6183739	6116 15 4		200
				/m		GEK-KS45	Aluminium/ PVC	6183739	6116 15 4		203
GEK-AOT45	Aluminium/ AI / EL	6202034	6116 55 8		200	GEK-KS45-3	Pure white/ PVC	5391647	6116 16 3		194
GEK-AOT45	Aluminium/ AI / EL	6202034	6116 55 8		203						
						GEK-KT53160-3	Pure white/ PVC	5391654	6116 19 3		195
				/pc.							
GEK-AT100213DEL	/ AI / EL	5142539	6285 36 3		300	GEK-KTF53100	Pure white/ PVC	5391982	6116 18 0		190
GEK-AT100213DRW	Pure white/ AI / FS	5142508	6285 36 0		300	GEK-KTF53100	Aluminium/ PVC	5392026	6116 18 1		202
						GEK-KTF53160	Pure white/ PVC	5392033	6116 18 4		193
GEK-AT70110EL	/ AI / EL	5157267	6285 46 3		267	GEK-KTF53160	Aluminium/ PVC	5392040	6116 18 5		205
GEK-AT70110RW	Pure white/ AI / FS	5157250	6285 46 0		267						
GEK-AT70133EL	/ AI / EL	5141051	6284 46 3		273	GEK-KTS53100	Pure white/ PVC	5391913	6116 16 7		189
GEK-AT70133RW	Pure white/ AI / FS	5141044	6284 46 0		273	GEK-KTS53100	Aluminium/ PVC	5391920	6116 16 9		202
GEK-AT70213DEL	/ AI / EL	5142317	6285 26 3		297	GEK-KTS53160	Pure white/ PVC	5391968	6116 17 2		193
GEK-AT70213DRW	Pure white/ AI / FS	5142300	6285 26 0		297	GEK-KTS53160	Aluminium/ PVC	5391975	6116 17 4		205
GEK-AT90110EL	/ AI / EL	5157557	6285 56 3		270	GEK-LZ		5427650	6270 67 0		196
GEK-AT90110RW	Pure white/ AI / FS	5157540	6285 56 0		270						
GEK-AT90133EL	/ AI / EL	5141273	6284 56 3		276					/m	
GEK-AT90133RW	Pure white/ AI / FS	5141242	6284 56 0		276	GK-70110CW	Cream 2000/ PVC	5656333	6274 30 1		208
						GK-70110GR	Stone grey 2000/ PVC	5656371	6274 30 6		208
				/m		GK-70110LGR	Light grey 2000/ PVC	5656340	6274 30 2		208
GEK-K53100	Pure white 2000/ PVC	6292578	6116 02 7		188	GK-70110RW	Pure white 2000/ PVC	5655473	6274 30 0		208
GEK-K53160	Pure white 2000/ PVC	6292516	6116 05 1		191						
GEK-K53160-3	Pure white 2000/ PVC	5391630	6116 07 3		194	GK-70130CW	Cream 2000/ PVC	5656746	6274 50 1		211
						GK-70130GR	Stone grey 2000/ PVC	5656760	6274 50 6		211
				/pc.		GK-70130LGR	Light grey 2000/ PVC	5656753	6274 50 2		211
GEK-KA53100	Pure white/ PVC	6441013	6116 26 4		189	GK-70130RW	Pure white 2000/ PVC	5656739	6274 50 0		211
GEK-KA53100	Aluminium/ PVC	6184033	6116 26 9		201						
GEK-KA53160	Pure white/ PVC	6616879	6116 28 0		192	GK-70170CW	Cream 2000/ PVC	5657057	6274 70 1		214
GEK-KA53160	Aluminium/ PVC	6184811	6116 28 5		204	GK-70170GR	Stone grey 2000/ PVC	5657071	6274 70 6		214
GEK-KA53160-3	Pure white/ PVC	5428695	6116 26 1		195	GK-70170LGR	Light grey 2000/ PVC	5657064	6274 70 2		214
						GK-70170RW	Pure white 2000/ PVC	5657040	6274 70 0		214
GEK-KAS53100	Pure white/ PVC	6192915	6116 27 2		189						
GEK-KAS53160	Pure white/ PVC	6193158	6116 29 4		192	GK-A70110CW	Cream / PVC	5656432	6274 31 1	/pc.	209
GEK-KAS53160-3	Pure white/ PVC	5391678	6116 26 3		195	GK-A70110GR	Stone grey / PVC	5656456	6274 31 6		209
						GK-A70110LGR	Light grey / PVC	5656449	6274 31 2		209
GEK-KE53160-3	Pure white/ PVC	5391685	6116 40 3		195	GK-A70110RW	Pure white / PVC	5656401	6274 31 0		209
GEK-KEL53100	Pure white/ PVC	6441075	6116 30 2		190	GK-A70130CW	Cream / PVC	5656807	6274 51 1		212
GEK-KEL53100	Aluminium/ PVC	6184095	6116 30 7		202	GK-A70130GR	Stone grey / PVC	5656821	6274 51 6		212
GEK-KEL53160	Pure white/ PVC	6441136	6116 32 9		193	GK-A70130LGR	Light grey / PVC	5656814	6274 51 2		212
GEK-KEL53160	Aluminium/ PVC	6184873	6116 33 4		205	GK-A70130RW	Pure white / PVC	5656791	6274 51 0		212
GEK-KER53100	Pure white/ PVC	6616930	6116 35 3		190	GK-A70170CW	Cream / PVC	5657118	6274 71 1		215
GEK-KER53100	Aluminium/ PVC	6184217	6116 35 8		202	GK-A70170GR	Stone grey / PVC	5657132	6274 71 6		215
GEK-KER53160	Pure white/ PVC	6441198	6116 38 8		193	GK-A70170LGR	Light grey / PVC	5657125	6274 71 2		215
GEK-KER53160	Aluminium/ PVC	6184934	6116 39 3		205	GK-A70170RW	Pure white / PVC	5657101	6274 71 0		215
GEK-KF53160-3	Pure white/ PVC	5391692	6116 49 3		194	GK-E70110CW	Cream / PVC	5656647	6274 37 1		210
						GK-E70110GR	Stone grey / PVC	5656685	6274 37 6		210
GEK-KFF53100	Pure white/ PVC	6184514	6116 46 4		188	GK-E70110LGR	Light grey / PVC	5656678	6274 37 2		210
GEK-KFF53160	Pure white/ PVC	6191239	6116 48 0		191	GK-E70110RW	Pure white / PVC	5656630	6274 37 0		210
GEK-KFS53100	Pure white/ PVC	6184330	6116 41 8		188						
GEK-KFS53160	Pure white/ PVC	6184996	6116 43 4		191	GK-E70130CW	Cream / PVC	5656968	6274 57 1		213
						GK-E70130GR	Stone grey / PVC	5656982	6274 57 6		213
GEK-KI53100	Pure white/ PVC	6709038	6116 20 5		189	GK-E70130LGR	Light grey / PVC	5656975	6274 57 2		213
GEK-KI53100	Aluminium/ PVC	6183678	6116 21 0		201	GK-E70130RW	Pure white / PVC	5656951	6274 57 0		213
GEK-KI53160	Pure white/ PVC	6440955	6116 22 1		192						
GEK-KI53160	Aluminium/ PVC	6184699	6116 22 6		204	GK-E70170CW	Cream / PVC	5657279	6274 77 1		216
GEK-KI53160-3	Pure white/ PVC	5428688	6116 20 1		194	GK-E70170GR	Stone grey / PVC	5657293	6274 77 6		216
						GK-E70170LGR	Light grey / PVC	5657286	6274 77 2		216
GEK-KIS53100	Pure white/ PVC	6192793	6116 21 3		189	GK-E70170RW	Pure white / PVC	5657262	6274 77 0		216
GEK-KIS53160	Pure white/ PVC	6192977	6116 24 8		192						
GEK-KIS53160-3	Pure white/ PVC	5391661	6116 20 3		195	GK-F70110CW	Cream / PVC	5656463	6274 32 1		209
						GK-F70110GR	Stone grey / PVC	5656500	6274 32 6		209
GEK-KK53100	Pure white/ PVC	5391883	6116 49 5		190	GK-F70110LGR	Light grey / PVC	5656494	6274 32 2		209
GEK-KK53100	Aluminium/ PVC	5391890	6116 49 6		202	GK-F70110RW	Pure white / PVC	5655664	6274 32 0		209
GEK-KK53160	Pure white/ PVC	5392088	6116 49 8		193						
GEK-KK53160	Aluminium/ PVC	5392095	6116 49 9		205	GK-F70130CW	Cream / PVC	5656845	6274 52 1		212
						GK-F70130GR	Stone grey / PVC	5656869	6274 52 6		212
				/m		GK-F70130LGR	Light grey / PVC	5656852	6274 52 2		212
GEK-KOT45	Pure white 2000/ PVC	6708970	6116 10 8		188	GK-F70130RW	Pure white / PVC	5656838	6274 52 0		212
GEK-KOT45	Pure white 2000/ PVC	6708970	6116 10 8		191						
GEK-KOT45	Pure white 2000/ PVC	6708970	6116 10 8		194	GK-F70170CW	Cream / PVC	5657156	6274 72 1		215
						GK-F70170GR	Stone grey / PVC	5657170	6274 72 6		215
						GK-F70170LGR	Light grey / PVC	5657163	6274 72 2		215

Type listing

Structure of the EAN number: Country code 40

Manufacturer code 1219 (for articles beginning with 0: 1010)

Individual EAN-C 5647589

Type	Dimensions/Colour/Div.	EAN-C.	Art. no.	Price	Page	Type	Dimensions/Colour/Div.	EAN-C.	Art. no.	Price	Page
GK-F70170RW	Pure white/ PVC	5657149	6274 72 0	/pc.	215	GK-OTGFCW	Cream/ PVC	5656708	6274 49 1	/pc.	261
GK-I70110CW	Cream/ PVC	5656524	6274 34 1		210	GK-OTGFGR	Stone grey/ PVC	5656722	6274 49 6		209
GK-I70110GR	Stone grey/ PVC	5656562	6274 34 6		210	GK-OTGFGR	Stone grey/ PVC	5656722	6274 49 6		212
GK-I70110LGR	Light grey/ PVC	5656555	6274 34 2		210	GK-OTGFGR	Stone grey/ PVC	5656722	6274 49 6		215
GK-I70110RW	Pure white/ PVC	5656517	6274 34 0		210						
						GK-OTGFLGR	Light grey/ PVC	5656715	6274 49 2		209
GK-I70130CW	Cream/ PVC	5656883	6274 54 1		213	GK-OTGFLGR	Light grey/ PVC	5656715	6274 49 2		212
GK-I70130GR	Stone grey/ PVC	5656906	6274 54 6		213	GK-OTGFLGR	Light grey/ PVC	5656715	6274 49 2		215
GK-I70130LGR	Light grey/ PVC	5656890	6274 54 2		213	GK-OTGFLGR	Light grey/ PVC	5656715	6274 49 2		223
GK-I70130RW	Pure white/ PVC	5656876	6274 54 0		213	GK-OTGFLGR	Light grey/ PVC	5656715	6274 49 2		228
						GK-OTGFLGR	Light grey/ PVC	5656715	6274 49 2		233
GK-I70170CW	Cream/ PVC	5657194	6274 74 1		216	GK-OTGFLGR	Light grey/ PVC	5656715	6274 49 2		239
GK-I70170GR	Stone grey/ PVC	5657217	6274 74 6		216	GK-OTGFLGR	Light grey/ PVC	5656715	6274 49 2		244
GK-I70170LGR	Light grey/ PVC	5657200	6274 74 2		216	GK-OTGFLGR	Light grey/ PVC	5656715	6274 49 2		255
GK-I70170RW	Pure white/ PVC	5657187	6274 74 0		216	GK-OTGFLGR	Light grey/ PVC	5656715	6274 49 2		261
GK-KUP	Light grey/ ABS/ASA	5657033	6274 65 0		208	GK-OTGFRW	Pure white/ PVC	5656692	6274 49 0		209
GK-KUP	Light grey/ ABS/ASA	5657033	6274 65 0		211	GK-OTGFRW	Pure white/ PVC	5656692	6274 49 0		212
GK-KUP	Light grey/ ABS/ASA	5657033	6274 65 0		214	GK-OTGFRW	Pure white/ PVC	5656692	6274 49 0		215
						GK-OTGFRW	Pure white/ PVC	5656692	6274 49 0		223
GK-OTGACW	Cream/ PVC	5657347	6274 79 1		209	GK-OTGFRW	Pure white/ PVC	5656692	6274 49 0		228
GK-OTGACW	Cream/ PVC	5657347	6274 79 1		212	GK-OTGFRW	Pure white/ PVC	5656692	6274 49 0		233
GK-OTGACW	Cream/ PVC	5657347	6274 79 1		215	GK-OTGFRW	Pure white/ PVC	5656692	6274 49 0		239
GK-OTGACW	Cream/ PVC	5657347	6274 79 1		222	GK-OTGFRW	Pure white/ PVC	5656692	6274 49 0		244
GK-OTGACW	Cream/ PVC	5657347	6274 79 1		227	GK-OTGFRW	Pure white/ PVC	5656692	6274 49 0		255
GK-OTGACW	Cream/ PVC	5657347	6274 79 1		232	GK-OTGFRW	Pure white/ PVC	5656692	6274 49 0		261
GK-OTGACW	Cream/ PVC	5657347	6274 79 1		238						
GK-OTGACW	Cream/ PVC	5657347	6274 79 1		243						
GK-OTGACW	Cream/ PVC	5657347	6274 79 1		254	GK-OTGGR	Stone grey 2000/ PVC	5666486	6278 68 6	/m	208
GK-OTGACW	Cream/ PVC	5657347	6274 79 1		260	GK-OTGGR	Stone grey 2000/ PVC	5666486	6278 68 6		211
						GK-OTGGR	Stone grey 2000/ PVC	5666486	6278 68 6		214
GK-OTGAGR	Stone grey/ PVC	5657361	6274 79 6		209						
GK-OTGAGR	Stone grey/ PVC	5657361	6274 79 6		212	GK-OTGLGR	Light grey 2000/ PVC	5666424	6278 68 2		208
GK-OTGAGR	Stone grey/ PVC	5657361	6274 79 6		215	GK-OTGLGR	Light grey 2000/ PVC	5666424	6278 68 2		211
						GK-OTGLGR	Light grey 2000/ PVC	5666424	6278 68 2		214
GK-OTGALGR	Light grey/ PVC	5657354	6274 79 2		209	GK-OTGLGR	Light grey 2000/ PVC	5666424	6278 68 2		221
GK-OTGALGR	Light grey/ PVC	5657354	6274 79 2		212	GK-OTGLGR	Light grey 2000/ PVC	5666424	6278 68 2		226
GK-OTGALGR	Light grey/ PVC	5657354	6274 79 2		215	GK-OTGLGR	Light grey 2000/ PVC	5666424	6278 68 2		231
GK-OTGALGR	Light grey/ PVC	5657354	6274 79 2		222	GK-OTGLGR	Light grey 2000/ PVC	5666424	6278 68 2		237
GK-OTGALGR	Light grey/ PVC	5657354	6274 79 2		227	GK-OTGLGR	Light grey 2000/ PVC	5666424	6278 68 2		242
GK-OTGALGR	Light grey/ PVC	5657354	6274 79 2		232	GK-OTGLGR	Light grey 2000/ PVC	5666424	6278 68 2		253
GK-OTGALGR	Light grey/ PVC	5657354	6274 79 2		238	GK-OTGLGR	Light grey 2000/ PVC	5666424	6278 68 2		259
GK-OTGALGR	Light grey/ PVC	5657354	6274 79 2		243						
GK-OTGALGR	Light grey/ PVC	5657354	6274 79 2		254	GK-OTGRW	Pure white 2000/ PVC	5666400	6278 68 0		208
GK-OTGALGR	Light grey/ PVC	5657354	6274 79 2		260	GK-OTGRW	Pure white 2000/ PVC	5666400	6278 68 0		211
						GK-OTGRW	Pure white 2000/ PVC	5666400	6278 68 0		214
GK-OTGARW	Pure white/ PVC	5657309	6274 79 0		209	GK-OTGRW	Pure white 2000/ PVC	5666400	6278 68 0		221
GK-OTGARW	Pure white/ PVC	5657309	6274 79 0		212	GK-OTGRW	Pure white 2000/ PVC	5666400	6278 68 0		226
GK-OTGARW	Pure white/ PVC	5657309	6274 79 0		215	GK-OTGRW	Pure white 2000/ PVC	5666400	6278 68 0		231
GK-OTGARW	Pure white/ PVC	5657309	6274 79 0		222	GK-OTGRW	Pure white 2000/ PVC	5666400	6278 68 0		237
GK-OTGARW	Pure white/ PVC	5657309	6274 79 0		227	GK-OTGRW	Pure white 2000/ PVC	5666400	6278 68 0		242
GK-OTGARW	Pure white/ PVC	5657309	6274 79 0		232	GK-OTGRW	Pure white 2000/ PVC	5666400	6278 68 0		253
GK-OTGARW	Pure white/ PVC	5657309	6274 79 0		238	GK-OTGRW	Pure white 2000/ PVC	5666400	6278 68 0		259
GK-OTGARW	Pure white/ PVC	5657309	6274 79 0		243						
GK-OTGARW	Pure white/ PVC	5657309	6274 79 0		254						
GK-OTGARW	Pure white/ PVC	5657309	6274 79 0		260	GK-OTKACW	Cream/ PVC	5658061	6274 89 1	/pc.	209
						GK-OTKACW	Cream/ PVC	5658061	6274 89 1		212
GK-OTGCW	Cream 2000/ PVC	5666417	6278 68 1	/m	208	GK-OTKACW	Cream/ PVC	5658061	6274 89 1		215
GK-OTGCW	Cream 2000/ PVC	5666417	6278 68 1		211	GK-OTKACW	Cream/ PVC	5658061	6274 89 1		222
GK-OTGCW	Cream 2000/ PVC	5666417	6278 68 1		214	GK-OTKACW	Cream/ PVC	5658061	6274 89 1		227
GK-OTGCW	Cream 2000/ PVC	5666417	6278 68 1		221	GK-OTKACW	Cream/ PVC	5658061	6274 89 1		232
GK-OTGCW	Cream 2000/ PVC	5666417	6278 68 1		226	GK-OTKACW	Cream/ PVC	5658061	6274 89 1		238
GK-OTGCW	Cream 2000/ PVC	5666417	6278 68 1		231	GK-OTKACW	Cream/ PVC	5658061	6274 89 1		243
GK-OTGCW	Cream 2000/ PVC	5666417	6278 68 1		237	GK-OTKACW	Cream/ PVC	5658061	6274 89 1		254
GK-OTGCW	Cream 2000/ PVC	5666417	6278 68 1		242						
GK-OTGCW	Cream 2000/ PVC	5666417	6278 68 1		253	GK-OTKAGR	Stone grey/ PVC	5658085	6274 89 6		209
GK-OTGCW	Cream 2000/ PVC	5666417	6278 68 1		259	GK-OTKAGR	Stone grey/ PVC	5658085	6274 89 6		212
						GK-OTKAGR	Stone grey/ PVC	5658085	6274 89 6		215
GK-OTGFCW	Cream/ PVC	5656708	6274 49 1	/pc.	209	GK-OTKALGR	Light grey/ PVC	5658078	6274 89 2		209
GK-OTGFCW	Cream/ PVC	5656708	6274 49 1		212	GK-OTKALGR	Light grey/ PVC	5658078	6274 89 2		212
GK-OTGFCW	Cream/ PVC	5656708	6274 49 1		215	GK-OTKALGR	Light grey/ PVC	5658078	6274 89 2		215
GK-OTGFCW	Cream/ PVC	5656708	6274 49 1		223	GK-OTKALGR	Light grey/ PVC	5658078	6274 89 2		222
GK-OTGFCW	Cream/ PVC	5656708	6274 49 1		228	GK-OTKALGR	Light grey/ PVC	5658078	6274 89 2		227
GK-OTGFCW	Cream/ PVC	5656708	6274 49 1		233	GK-OTKALGR	Light grey/ PVC	5658078	6274 89 2		232
GK-OTGFCW	Cream/ PVC	5656708	6274 49 1		239	GK-OTKALGR	Light grey/ PVC	5658078	6274 89 2		238
GK-OTGFCW	Cream/ PVC	5656708	6274 49 1		244	GK-OTKALGR	Light grey/ PVC	5658078	6274 89 2		243
GK-OTGFCW	Cream/ PVC	5656708	6274 49 1		255						

06 LFS_Katalog_2010_Neuer_Stand / en / 22/02/2010 (LLExport_00995)

Type	Dimensions/Colour/Div.	EAN-C.	Art. no.	Price	Page	Type	Dimensions/Colour/Div.	EAN-C.	Art. no.	Price	Page
GK-OTKALGR	Light grey / PVC	5658078	6274 89 2	/pc.	254	GK-OTKRW	Pure white 2000 / PVC	5666530	6278 78 0	/m	209
GK-OTKALGR	Light grey / PVC	5658078	6274 89 2		260	GK-OTKRW	Pure white 2000 / PVC	5666530	6278 78 0		212
						GK-OTKRW	Pure white 2000 / PVC	5666530	6278 78 0		215
GK-OTKARW	Pure white / PVC	5658023	6274 89 0		209	GK-OTKRW	Pure white 2000 / PVC	5666530	6278 78 0		221
GK-OTKARW	Pure white / PVC	5658023	6274 89 0		212	GK-OTKRW	Pure white 2000 / PVC	5666530	6278 78 0		226
GK-OTKARW	Pure white / PVC	5658023	6274 89 0		215	GK-OTKRW	Pure white 2000 / PVC	5666530	6278 78 0		231
GK-OTKARW	Pure white / PVC	5658023	6274 89 0		222	GK-OTKRW	Pure white 2000 / PVC	5666530	6278 78 0		237
GK-OTKARW	Pure white / PVC	5658023	6274 89 0		227	GK-OTKRW	Pure white 2000 / PVC	5666530	6278 78 0		242
GK-OTKARW	Pure white / PVC	5658023	6274 89 0		232	GK-OTKRW	Pure white 2000 / PVC	5666530	6278 78 0		253
GK-OTKARW	Pure white / PVC	5658023	6274 89 0		238	GK-OTKRW	Pure white 2000 / PVC	5666530	6278 78 0		259
GK-OTKARW	Pure white / PVC	5658023	6274 89 0		243						
GK-OTKARW	Pure white / PVC	5658023	6274 89 0		254					/pc.	
GK-OTKARW	Pure white / PVC	5658023	6274 89 0		260	GK-T70110CW	Cream / PVC	5656586	6274 36 1		210
						GK-T70110GR	Stone grey / PVC	5656623	6274 36 6		210
				/m		GK-T70110LGR	Light grey / PVC	5656616	6274 36 2		210
GK-OTKCW	Cream 2000 / PVC	5666547	6278 78 1		209	GK-T70110RW	Pure white / PVC	5656579	6274 36 0		210
GK-OTKCW	Cream 2000 / PVC	5666547	6278 78 1		212						
GK-OTKCW	Cream 2000 / PVC	5666547	6278 78 1		215	GK-T70130CW	Cream / PVC	5656920	6274 56 1		213
GK-OTKCW	Cream 2000 / PVC	5666547	6278 78 1		221	GK-T70130GR	Stone grey / PVC	5656944	6274 56 6		213
GK-OTKCW	Cream 2000 / PVC	5666547	6278 78 1		226	GK-T70130LGR	Light grey / PVC	5656937	6274 56 2		213
GK-OTKCW	Cream 2000 / PVC	5666547	6278 78 1		231	GK-T70130RW	Pure white / PVC	5656913	6274 56 0		213
GK-OTKCW	Cream 2000 / PVC	5666547	6278 78 1		237						
GK-OTKCW	Cream 2000 / PVC	5666547	6278 78 1		242	GK-T70170CW	Cream / PVC	5657231	6274 76 1		216
GK-OTKCW	Cream 2000 / PVC	5666547	6278 78 1		253	GK-T70170GR	Stone grey / PVC	5657255	6274 76 6		216
GK-OTKCW	Cream 2000 / PVC	5666547	6278 78 1		259	GK-T70170LGR	Light grey / PVC	5657248	6274 76 2		216
				/pc.		GK-T70170RW	Pure white / PVC	5657224	6274 76 0		216
GK-OTKFCW	Cream / PVC	5657002	6274 59 1		210					/m	
GK-OTKFCW	Cream / PVC	5657002	6274 59 1		213	GK-TW70	2000 / PVC	5658122	6274 90 0		210
GK-OTKFCW	Cream / PVC	5657002	6274 59 1		216	GK-TW70	2000 / PVC	5658122	6274 90 0		213
GK-OTKFCW	Cream / PVC	5657002	6274 59 1		223	GK-TW70	2000 / PVC	5658122	6274 90 0		216
GK-OTKFCW	Cream / PVC	5657002	6274 59 1		228						
GK-OTKFCW	Cream / PVC	5657002	6274 59 1		233					/pc.	
GK-OTKFCW	Cream / PVC	5657002	6274 59 1		239	G-KWAG70110CW	Cream 178 / ABS/ASA	5657729	6274 85 1		309
GK-OTKFCW	Cream / PVC	5657002	6274 59 1		244	G-KWAG70110GR	Stone grey 178 / ABS/ASA	5657774	6274 85 6		309
GK-OTKFCW	Cream / PVC	5657002	6274 59 1		255	G-KWAG70110LGR	Light grey 178 / ABS/ASA	5657767	6274 85 2		309
GK-OTKFCW	Cream / PVC	5657002	6274 59 1		261	G-KWAG70110RW	Pure white 178 / ABS/ASA	5657712	6274 85 0		309
						G-KWAG70130CW	Cream 198 / ABS/ASA	5657828	6274 86 1		309
GK-OTKFGR	Stone grey / PVC	5657026	6274 59 6		210	G-KWAG70130GR	Stone grey 198 / ABS/ASA	5657842	6274 86 6		309
GK-OTKFGR	Stone grey / PVC	5657026	6274 59 6		213	G-KWAG70130LGR	Light grey 198 / ABS/ASA	5657835	6274 86 2		309
GK-OTKFGR	Stone grey / PVC	5657026	6274 59 6		216	G-KWAG70130RW	Pure white 198 / ABS/ASA	5657781	6274 86 0		309
						G-KWAG70170CW	Cream 238 / ABS/ASA	5657897	6274 87 1		309
GK-OTKFLGR	Light grey / PVC	5657019	6274 59 2		210	G-KWAG70170GR	Stone grey 238 / ABS/ASA	5657941	6274 87 6		309
GK-OTKFLGR	Light grey / PVC	5657019	6274 59 2		213	G-KWAG70170LGR	Light grey 238 / ABS/ASA	5657903	6274 87 2		309
GK-OTKFLGR	Light grey / PVC	5657019	6274 59 2		216	G-KWAG70170RW	Pure white 238 / ABS/ASA	5657880	6274 87 0		309
GK-OTKFLGR	Light grey / PVC	5657019	6274 59 2		223	G-KWAG70210CW	Cream 278 / ABS/ASA	5657965	6274 88 1		310
GK-OTKFLGR	Light grey / PVC	5657019	6274 59 2		228	G-KWAG70210LGR	Light grey 278 / ABS/ASA	5658009	6274 88 2		310
GK-OTKFLGR	Light grey / PVC	5657019	6274 59 2		233	G-KWAG70210RW	Pure white 278 / ABS/ASA	5657958	6274 88 0		310
GK-OTKFLGR	Light grey / PVC	5657019	6274 59 2		239						
GK-OTKFLGR	Light grey / PVC	5657019	6274 59 2		244	G-KWAG90110CW	Cream 178 / ABS/ASA	5658481	6274 95 1		309
GK-OTKFLGR	Light grey / PVC	5657019	6274 59 2		255	G-KWAG90110LGR	Light grey 178 / ABS/ASA	5658498	6274 95 2		309
GK-OTKFLGR	Light grey / PVC	5657019	6274 59 2		261	G-KWAG90110RW	Pure white 178 / ABS/ASA	5658443	6274 95 0		309
						G-KWAG90130CW	Cream 198 / ABS/ASA	5658559	6274 96 1		309
GK-OTKFRW	Pure white / PVC	5656999	6274 59 0		210	G-KWAG90130LGR	Light grey 198 / ABS/ASA	5658566	6274 96 2		309
GK-OTKFRW	Pure white / PVC	5656999	6274 59 0		213	G-KWAG90130RW	Pure white 198 / ABS/ASA	5658542	6274 96 0		309
GK-OTKFRW	Pure white / PVC	5656999	6274 59 0		216	G-KWAG90170CW	Cream 238 / ABS/ASA	5658597	6274 97 1		309
GK-OTKFRW	Pure white / PVC	5656999	6274 59 0		223	G-KWAG90170LGR	Light grey 238 / ABS/ASA	5658603	6274 97 2		309
GK-OTKFRW	Pure white / PVC	5656999	6274 59 0		228	G-KWAG90170RW	Pure white 238 / ABS/ASA	5658580	6274 97 0		309
GK-OTKFRW	Pure white / PVC	5656999	6274 59 0		233	G-KWAG90210CW	Cream 278 / ABS/ASA	5658665	6274 98 1		310
GK-OTKFRW	Pure white / PVC	5656999	6274 59 0		239	G-KWAG90210LGR	Light grey 278 / ABS/ASA	5658672	6274 98 2		310
GK-OTKFRW	Pure white / PVC	5656999	6274 59 0		244	G-KWAG90210RW	Pure white 278 / ABS/ASA	5658627	6274 98 0		310
GK-OTKFRW	Pure white / PVC	5656999	6274 59 0		255						
GK-OTKFRW	Pure white / PVC	5656999	6274 59 0		261	G-KWAO70110CW	Cream 178 / ABS/ASA	5657415	6274 81 1		307
						G-KWAO70110GR	Stone grey 178 / ABS/ASA	5657460	6274 81 6		307
				/m		G-KWAO70110LGR	Light grey 178 / ABS/ASA	5657422	6274 81 2		307
GK-OTKGR	Stone grey 2000 / PVC	5666578	6278 78 6		209	G-KWAO70110RW	Pure white 178 / ABS/ASA	5657408	6274 81 0		307
GK-OTKGR	Stone grey 2000 / PVC	5666578	6278 78 6		212	G-KWAO70130CW	Cream 198 / ABS/ASA	5657484	6274 82 1		308
GK-OTKGR	Stone grey 2000 / PVC	5666578	6278 78 6		215	G-KWAO70130GR	Stone grey 198 / ABS/ASA	5657538	6274 82 6		308
						G-KWAO70130LGR	Light grey 198 / ABS/ASA	5657521	6274 82 2		308
GK-OTKLGR	Light grey 2000 / PVC	5666554	6278 78 2		209	G-KWAO70130RW	Pure white 198 / ABS/ASA	5657477	6274 82 0		308
GK-OTKLGR	Light grey 2000 / PVC	5666554	6278 78 2		212	G-KWAO70170CW	Cream 238 / ABS/ASA	5657583	6274 83 1		308
GK-OTKLGR	Light grey 2000 / PVC	5666554	6278 78 2		215	G-KWAO70170GR	Stone grey 238 / ABS/ASA	5657606	6274 83 6		308
GK-OTKLGR	Light grey 2000 / PVC	5666554	6278 78 2		221	G-KWAO70170LGR	Light grey 238 / ABS/ASA	5657590	6274 83 2		308
GK-OTKLGR	Light grey 2000 / PVC	5666554	6278 78 2		226	G-KWAO70170RW	Pure white 238 / ABS/ASA	5657545	6274 83 0		308
GK-OTKLGR	Light grey 2000 / PVC	5666554	6278 78 2		231	G-KWAO70210CW	Cream 278 / ABS/ASA	5657651	6274 84 1		308
GK-OTKLGR	Light grey 2000 / PVC	5666554	6278 78 2		237	G-KWAO70210LGR	Light grey 278 / ABS/ASA	5657668	6274 84 2		308
GK-OTKLGR	Light grey 2000 / PVC	5666554	6278 78 2		242	G-KWAO70210RW	Pure white 278 / ABS/ASA	5657644	6274 84 0		308
GK-OTKLGR	Light grey 2000 / PVC	5666554	6278 78 2		253						
GK-OTKLGR	Light grey 2000 / PVC	5666554	6278 78 2		259	G-KWAO90110CW	Cream 178 / ABS/ASA	5658146	6274 91 1		307

Type listing

Structure of the EAN number: Country code **40**

Manufacturer code **1219** (for articles beginning with **0: 1010**)

Individual EAN-C **5647589**

Type	Dimensions/Colour/Div.	EAN-C.	Art. no.	Price	Page	Type	Dimensions/Colour/Div.	EAN-C.	Art. no.	Price	Page
				/pc.						/pc.	
G-KWAO90110LGR	Light grey 178 / ABS/ASA	5658184	6274 91 2		307	GS-AFS70130CW	Cream / St / FS	5661382	6277 42 1		232
G-KWAO90110RW	Pure white 178 / ABS/ASA	5658139	6274 91 0		307	GS-AFS70130LGR	Light grey / St / FS	5661429	6277 42 2		232
G-KWAO90130CW	Cream 198 / ABS/ASA	5658245	6274 92 1		308	GS-AFS70130RW	Pure white / St / FS	5661375	6277 42 0		232
G-KWAO90130LGR	Light grey 198 / ABS/ASA	5658252	6274 92 2		308	GS-AFS70170CW	Cream / St / FS	5663119	6277 82 1		243
G-KWAO90130RW	Pure white 198 / ABS/ASA	5658207	6274 92 0		308	GS-AFS70170LGR	Light grey / St / FS	5663126	6277 82 2		243
G-KWAO90170CW	Cream 238 / ABS/ASA	5658313	6274 93 1		308	GS-AFS70170RW	Pure white / St / FS	5663102	6277 82 0		243
G-KWAO90170LGR	Light grey 238 / ABS/ASA	5658320	6274 93 2		308	GS-AFS70210CW	Cream / St / FS	5663874	6278 02 1		254
G-KWAO90170RW	Pure white 238 / ABS/ASA	5658306	6274 93 0		308	GS-AFS70210LGR	Light grey / St / FS	5663881	6278 02 2		254
G-KWAO90210CW	Cream 278 / ABS/ASA	5658382	6274 94 1		308	GS-AFS70210RW	Pure white / St / FS	5663867	6278 02 0		254
G-KWAO90210LGR	Light grey 278 / ABS/ASA	5658429	6274 94 2		308						
G-KWAO90210RW	Pure white 278 / ABS/ASA	5658375	6274 94 0		308	GS-AFS90130CW	Cream / St / FS	5661993	6277 52 1		232
				/m		GS-AFS90130LGR	Light grey / St / FS	5662006	6277 52 2		232
						GS-AFS90130RW	Pure white / St / FS	5661986	6277 52 0		232
GS-A70130CW	Cream 2000 / St / FS	5661146	6277 40 1		230	GS-AFS90170CW	Cream / St / FS	5663485	6277 92 1		243
GS-A70130LGR	Light grey 2000 / St / FS	5661184	6277 40 2		230	GS-AFS90170LGR	Light grey / St / FS	5663515	6277 92 2		243
GS-A70130RW	Pure white 2000 / St / FS	5661139	6277 40 0		230	GS-AFS90170RW	Pure white / St / FS	5663478	6277 92 0		243
						GS-AFS90210CW	Cream / St / FS	5664239	6278 12 1		254
GS-A70170CW	Cream 2000 / St / FS	5662976	6277 80 1		241	GS-AFS90210LGR	Light grey / St / FS	5664246	6278 12 2		254
GS-A70170LGR	Light grey 2000 / St / FS	5662983	6277 80 2		241	GS-AFS90210RW	Pure white / St / FS	5664222	6278 12 0		254
GS-A70170RW	Pure white 2000 / St / FS	5662945	6277 80 0		241						
						GS-AI70130CW	Cream / St / FS	5661566	6277 44 1		233
GS-A70210CW	Cream 2000 / St / FS	5663751	6278 00 1		252	GS-AI70130LGR	Light grey / St / FS	5661603	6277 44 2		233
GS-A70210LGR	Light grey 2000 / St / FS	5663768	6278 00 2		252	GS-AI70130RW	Pure white / St / FS	5661559	6277 44 0		233
GS-A70210RW	Pure white 2000 / St / FS	5663744	6278 00 0		252	GS-AI70170CW	Cream / St / FS	5663201	6277 84 1		244
						GS-AI70170LGR	Light grey / St / FS	5663218	6277 84 2		244
GS-A90130CW	Cream 2000 / St / FS	5661788	6277 50 1		230	GS-AI70170RW	Pure white / St / FS	5663195	6277 84 0		244
GS-A90130LGR	Light grey 2000 / St / FS	5661795	6277 50 2		230						
GS-A90130RW	Pure white 2000 / St / FS	5661740	6277 50 0		230	GS-AI70210CW	Cream / St / FS	5663966	6278 05 1		255
						GS-AI70210LGR	Light grey / St / FS	5663973	6278 05 2		255
GS-A90170CW	Cream 2000 / St / FS	5663324	6277 90 1		241	GS-AI70210RW	Pure white / St / FS	5663959	6278 05 0		255
GS-A90170LGR	Light grey 2000 / St / FS	5663331	6277 90 2		241						
GS-A90170RW	Pure white 2000 / St / FS	5663317	6277 90 0		241	GS-AI90130CW	Cream / St / FS	5662082	6277 54 1		233
						GS-AI90130LGR	Light grey / St / FS	5662099	6277 54 2		233
GS-A90210CW	Cream 2000 / St / FS	5664116	6278 10 1		252	GS-AI90130RW	Pure white / St / FS	5662075	6277 54 0		233
GS-A90210LGR	Light grey 2000 / St / FS	5664123	6278 10 2		252	GS-AI90170CW	Cream / St / FS	5663638	6277 94 1		244
GS-A90210RW	Pure white 2000 / St / FS	5664109	6278 10 0		252	GS-AI90170LGR	Light grey / St / FS	5663645	6277 94 2		244
				/pc.		GS-AI90170RW	Pure white / St / FS	5663607	6277 94 0		244
GS-AA70130CW	Cream / St / FS	5661306	6277 41 1		232	GS-AI90210CW	Cream / St / FS	5664383	6278 14 1		255
GS-AA70130LGR	Light grey / St / FS	5661313	6277 41 2		232	GS-AI90210LGR	Light grey / St / FS	5664420	6278 14 2		255
GS-AA70130RW	Pure white / St / FS	5661269	6277 41 0		232	GS-AI90210RW	Pure white / St / FS	5664376	6278 14 0		255
GS-AA70170CW	Cream / St / FS	5663041	6277 81 1		243						
GS-AA70170LGR	Light grey / St / FS	5663058	6277 81 2		243	GS-AT70130CW	Cream / St / FS	5661672	6277 46 1		234
GS-AA70170RW	Pure white / St / FS	5663034	6277 81 0		243	GS-AT70130LGR	Light grey / St / FS	5661689	6277 46 2		234
						GS-AT70130RW	Pure white / St / FS	5661665	6277 46 0		234
GS-AA70210CW	Cream / St / FS	5663829	6278 01 1		254	GS-AT70170CW	Cream / St / FS	5663270	6277 86 1		245
GS-AA70210LGR	Light grey / St / FS	5663836	6278 01 2		254	GS-AT70170LGR	Light grey / St / FS	5663287	6277 86 2		245
GS-AA70210RW	Pure white / St / FS	5663812	6278 01 0		254	GS-AT70170RW	Pure white / St / FS	5663249	6277 86 0		245
						GS-AA90130CW	Cream / St / FS	5661917	6277 51 1		256
GS-AA90130LGR	Light grey / St / FS	5661924	6277 51 2		232	GS-AT70210CW	Cream / St / FS	5664017	6278 06 1		256
GS-AA90130RW	Pure white / St / FS	5661900	6277 51 0		232	GS-AT70210LGR	Light grey / St / FS	5664024	6278 06 2		256
GS-AA90170CW	Cream / St / FS	5663416	6277 91 1		243	GS-AT70210RW	Pure white / St / FS	5664000	6278 06 0		256
GS-AA90170LGR	Light grey / St / FS	5663423	6277 91 2		243						
GS-AA90170RW	Pure white / St / FS	5663409	6277 91 0		243	GS-AT90130CW	Cream / St / FS	5662136	6277 56 1		234
						GS-AT90130LGR	Light grey / St / FS	5662143	6277 56 2		234
GS-AA90210CW	Cream / St / FS	5664185	6278 11 1		254	GS-AT90130RW	Pure white / St / FS	5662129	6277 56 0		234
GS-AA90210LGR	Light grey / St / FS	5664192	6278 11 2		254	GS-AT90170CW	Cream / St / FS	5663706	6277 96 1		245
GS-AA90210RW	Pure white / St / FS	5664178	6278 11 0		254	GS-AT90170LGR	Light grey / St / FS	5663713	6277 96 2		245
						GS-AT90170RW	Pure white / St / FS	5663690	6277 96 0		245
GS-AFF70130CW	Cream / St / FS	5661481	6277 43 1		233	GS-AT90210CW	Cream / St / FS	5664499	6278 16 1		256
GS-AFF70130LGR	Light grey / St / FS	5661498	6277 43 2		233	GS-AT90210LGR	Light grey / St / FS	5664505	6278 16 2		256
GS-AFF70130RW	Pure white / St / FS	5661443	6277 43 0		233	GS-AT90210RW	Pure white / St / FS	5664482	6278 16 0		256
GS-AFF70170CW	Cream / St / FS	5663157	6277 83 1		244						
GS-AFF70170LGR	Light grey / St / FS	5663164	6277 83 2		244						
GS-AFF70170RW	Pure white / St / FS	5663140	6277 83 0		244	GS-D70170CW	Cream 2000 / St / FS	5664673	6278 20 1	/m	247
GS-AFF70210CW	Cream / St / FS	5663911	6278 03 1		255	GS-D70170LGR	Light grey 2000 / St / FS	5664680	6278 20 2		247
GS-AFF70210LGR	Light grey / St / FS	5663928	6278 03 2		255	GS-D70170RW	Pure white 2000 / St / FS	5664666	6278 20 0		247
GS-AFF70210RW	Pure white / St / FS	5663904	6278 03 0		255						
						GS-D70210CW	Pure white 2000 / St / FS	5665557	6278 40 0		258
GS-AFF90130CW	Cream / St / FS	5662037	6277 53 1		233	GS-D70210LGR	Light grey 2000 / St / FS	5665571	6278 40 2		258
GS-AFF90130LGR	Light grey / St / FS	5662044	6277 53 2		233	GS-D70210RW	Cream 2000 / St / FS	5665564	6278 40 1		258
GS-AFF90130RW	Pure white / St / FS	5662020	6277 53 0		233						
GS-AFF90170CW	Cream / St / FS	5663546	6277 93 1		244	GS-D90170CW	Cream 2000 / St / FS	5665144	6278 30 1		247
GS-AFF90170LGR	Light grey / St / FS	5663577	6277 93 2		244	GS-D90170LGR	Light grey 2000 / St / FS	5665151	6278 30 2		247
GS-AFF90170RW	Pure white / St / FS	5663539	6277 93 0		244	GS-D90170RW	Pure white 2000 / St / FS	5665137	6278 30 0		247
GS-AFF90210CW	Cream / St / FS	5664307	6278 13 1		255						
GS-AFF90210LGR	Light grey / St / FS	5664314	6278 13 2		255	GS-D90210CW	Cream 2000 / St / FS	5666103	6278 50 1		258
GS-AFF90210RW	Pure white / St / FS	5664260	6278 13 0		255	GS-D90210LGR	Light grey 2000 / St / FS	5666110	6278 50 2		258
						GS-D90210RW	Pure white 2000 / St / FS	5666097	6278 50 0		258

06 LFS_Katalog_2010_Neuer_Stand / en / 22/02/2010 (LLExport_00995)

Type listing

Structure of the EAN number: Country code **40**

Manufacturer code **1219** (for articles beginning with **0: 1010**)

Individual EAN-C **5647589**

Type	Dimensions/Colour/Div.	EAN-C.	Art. no.	Price	Page	Type	Dimensions/Colour/Div.	EAN-C.	Art. no.	Price	Page
GS-OT50LGR	Light grey 2000/ St / FS	5680949	6279 88 2	/m	248	GS-OTLGR	Light grey 2000/ ST	5695868	6279 85 2	/m	248
GS-OT50LGR	Light grey 2000/ St / FS	5680949	6279 88 2		249	GS-OTLGR	Light grey 2000/ ST	5695868	6279 85 2		253
						GS-OTLGR	Light grey 2000/ ST	5695868	6279 85 2		259
GS-OT50RW	Pure white 2000/ St / FS	5680925	6279 88 0		248						
GS-OT50RW	Pure white 2000/ St / FS	5680925	6279 88 0		249	GS-OTRW	Pure white 2000/ ST	5695813	6279 85 0		221
						GS-OTRW	Pure white 2000/ ST	5695813	6279 85 0		226
						GS-OTRW	Pure white 2000/ ST	5695813	6279 85 0		231
						GS-OTRW	Pure white 2000/ ST	5695813	6279 85 0		237
GS-OTACW	Cream/ ST	5696063	6279 87 1	/pc.	222	GS-OTRW	Pure white 2000/ ST	5695813	6279 85 0		242
GS-OTACW	Cream/ ST	5696063	6279 87 1		227	GS-OTRW	Pure white 2000/ ST	5695813	6279 85 0		248
GS-OTACW	Cream/ ST	5696063	6279 87 1		232	GS-OTRW	Pure white 2000/ ST	5695813	6279 85 0		253
GS-OTACW	Cream/ ST	5696063	6279 87 1		238	GS-OTRW	Pure white 2000/ ST	5695813	6279 85 0		259
GS-OTACW	Cream/ ST	5696063	6279 87 1		243						
GS-OTACW	Cream/ ST	5696063	6279 87 1		249						
GS-OTACW	Cream/ ST	5696063	6279 87 1		254	GS-S70110CW	Cream 2000/ St / FS	5658733	6277 00 1		220
GS-OTACW	Cream/ ST	5696063	6279 87 1		260	GS-S70110LGR	Light grey 2000/ St / FS	5658740	6277 00 2		220
						GS-S70110RW	Pure white 2000/ St / FS	5658726	6277 00 0		220
GS-OTALGR	Light grey/ ST	5696100	6279 87 2		222						
GS-OTALGR	Light grey/ ST	5696100	6279 87 2		227	GS-S70130CW	Cream 2000/ St / FS	5660040	6277 20 1		225
GS-OTALGR	Light grey/ ST	5696100	6279 87 2		232	GS-S70130LGR	Light grey 2000/ St / FS	5660057	6277 20 2		225
GS-OTALGR	Light grey/ ST	5696100	6279 87 2		238	GS-S70130RW	Pure white 2000/ St / FS	5660002	6277 20 0		225
GS-OTALGR	Light grey/ ST	5696100	6279 87 2		243						
GS-OTALGR	Light grey/ ST	5696100	6279 87 2		249	GS-S70170CW	Cream 2000/ St / FS	5662181	6277 60 1		236
GS-OTALGR	Light grey/ ST	5696100	6279 87 2		254	GS-S70170LGR	Light grey 2000/ St / FS	5662198	6277 60 2		236
GS-OTALGR	Light grey/ ST	5696100	6279 87 2		260	GS-S70170RW	Pure white 2000/ St / FS	5662174	6277 60 0		236
GS-OTARW	Pure white/ ST	5696056	6279 87 0		222	GS-S90110CW	Cream 2000/ St / FS	5659396	6277 10 1		220
GS-OTARW	Pure white/ ST	5696056	6279 87 0		227	GS-S90110LGR	Light grey 2000/ St / FS	5659402	6277 10 2		220
GS-OTARW	Pure white/ ST	5696056	6279 87 0		232	GS-S90110RW	Pure white 2000/ St / FS	5659389	6277 10 0		220
GS-OTARW	Pure white/ ST	5696056	6279 87 0		238						
GS-OTARW	Pure white/ ST	5696056	6279 87 0		243	GS-S90130CW	Cream 2000/ St / FS	5660644	6277 30 1		225
GS-OTARW	Pure white/ ST	5696056	6279 87 0		249	GS-S90130LGR	Light grey 2000/ St / FS	5660651	6277 30 2		225
GS-OTARW	Pure white/ ST	5696056	6279 87 0		254	GS-S90130RW	Pure white 2000/ St / FS	5660606	6277 30 0		225
GS-OTARW	Pure white/ ST	5696056	6279 87 0		260						
						GS-S90170CW	Cream 2000/ St / FS	5662525	6277 70 1		236
						GS-S90170LGR	Light grey 2000/ St / FS	5662532	6277 70 2		236
						GS-S90170RW	Pure white 2000/ St / FS	5662518	6277 70 0		236
GS-OTCW	Cream 2000/ ST	5695820	6279 85 1	/m	221						
GS-OTCW	Cream 2000/ ST	5695820	6279 85 1		226						
GS-OTCW	Cream 2000/ ST	5695820	6279 85 1		231						
GS-OTCW	Cream 2000/ ST	5695820	6279 85 1		237	GS-SA70110CW	Cream/ St / FS	5658863	6277 01 1	/pc.	222
GS-OTCW	Cream 2000/ ST	5695820	6279 85 1		242	GS-SA70110LGR	Light grey/ St / FS	5658900	6277 01 2		222
GS-OTCW	Cream 2000/ ST	5695820	6279 85 1		248	GS-SA70110RW	Pure white/ St / FS	5658856	6277 01 0		222
GS-OTCW	Cream 2000/ ST	5695820	6279 85 1		253	GS-SA70130CW	Cream/ St / FS	5660170	6277 21 1		227
GS-OTCW	Cream 2000/ ST	5695820	6279 85 1		259	GS-SA70130LGR	Light grey/ St / FS	5660187	6277 21 2		227
						GS-SA70130RW	Pure white/ St / FS	5660163	6277 21 0		227
						GS-SA70170CW	Cream/ St / FS	5662259	6277 61 1		238
GS-OTFCW	Cream/ ST	5695943	6279 86 1	/pc.	223	GS-SA70170LGR	Light grey/ St / FS	5662266	6277 61 2		238
GS-OTFCW	Cream/ ST	5695943	6279 86 1		228	GS-SA70170RW	Pure white/ St / FS	5662242	6277 61 0		238
GS-OTFCW	Cream/ ST	5695943	6279 86 1		233						
GS-OTFCW	Cream/ ST	5695943	6279 86 1		239	GS-SA90110CW	Cream/ St / FS	5659525	6277 11 1		222
GS-OTFCW	Cream/ ST	5695943	6279 86 1		244	GS-SA90110LGR	Light grey/ St / FS	5659563	6277 11 2		222
GS-OTFCW	Cream/ ST	5695943	6279 86 1		250	GS-SA90110RW	Pure white/ St / FS	5659518	6277 11 0		222
GS-OTFCW	Cream/ ST	5695943	6279 86 1		255	GS-SA90130CW	Cream/ St / FS	5660774	6277 31 1		227
GS-OTFCW	Cream/ ST	5695943	6279 86 1		261	GS-SA90130LGR	Light grey/ St / FS	5660781	6277 31 2		227
						GS-SA90130RW	Pure white/ St / FS	5660767	6277 31 0		227
GS-OTFLGR	Light grey/ ST	5695981	6279 86 2		223	GS-SA90170CW	Cream/ St / FS	5662594	6277 71 1		238
GS-OTFLGR	Light grey/ ST	5695981	6279 86 2		228	GS-SA90170LGR	Light grey/ St / FS	5662600	6277 71 2		238
GS-OTFLGR	Light grey/ ST	5695981	6279 86 2		233	GS-SA90170RW	Pure white/ St / FS	5662587	6277 71 0		238
GS-OTFLGR	Light grey/ ST	5695981	6279 86 2		239						
GS-OTFLGR	Light grey/ ST	5695981	6279 86 2		244	GS-SFS70110CW	Cream/ St / FS	5658979	6277 02 1		222
GS-OTFLGR	Light grey/ ST	5695981	6279 86 2		250	GS-SFS70110LGR	Light grey/ St / FS	5658986	6277 02 2		222
GS-OTFLGR	Light grey/ ST	5695981	6279 86 2		255	GS-SFS70110RW	Pure white/ St / FS	5658962	6277 02 0		222
GS-OTFLGR	Light grey/ ST	5695981	6279 86 2		261	GS-SFS70130CW	Cream/ St / FS	5660286	6277 22 1		227
						GS-SFS70130LGR	Light grey/ St / FS	5660293	6277 22 2		227
GS-OTFRW	Pure white/ ST	5695936	6279 86 0		223	GS-SFS70130RW	Pure white/ St / FS	5660248	6277 22 0		227
GS-OTFRW	Pure white/ ST	5695936	6279 86 0		228	GS-SFS70170CW	Cream/ St / FS	5662327	6277 62 1		238
GS-OTFRW	Pure white/ ST	5695936	6279 86 0		233	GS-SFS70170LGR	Light grey/ St / FS	5662334	6277 62 2		238
GS-OTFRW	Pure white/ ST	5695936	6279 86 0		239	GS-SFS70170RW	Pure white/ St / FS	5662310	6277 62 0		238
GS-OTFRW	Pure white/ ST	5695936	6279 86 0		244						
GS-OTFRW	Pure white/ ST	5695936	6279 86 0		250	GS-SFS90110CW	Cream/ St / FS	5659631	6277 12 1		222
GS-OTFRW	Pure white/ ST	5695936	6279 86 0		255	GS-SFS90110LGR	Light grey/ St / FS	5659648	6277 12 2		222
GS-OTFRW	Pure white/ ST	5695936	6279 86 0		261	GS-SFS90110RW	Pure white/ St / FS	5659624	6277 12 0		222
						GS-SFS90130CW	Cream/ St / FS	5660828	6277 32 1		227
						GS-SFS90130LGR	Light grey/ St / FS	5660835	6277 32 2		227
						GS-SFS90130RW	Pure white/ St / FS	5660811	6277 32 0		227
GS-OTLGR	Light grey 2000/ ST	5695868	6279 85 2	/m	221	GS-SFS90170CW	Cream/ St / FS	5662648	6277 72 1		238
GS-OTLGR	Light grey 2000/ ST	5695868	6279 85 2		226	GS-SFS90170LGR	Light grey/ St / FS	5662679	6277 72 2		238
GS-OTLGR	Light grey 2000/ ST	5695868	6279 85 2		231	GS-SFS90170RW	Pure white/ St / FS	5662631	6277 72 0		238
GS-OTLGR	Light grey 2000/ ST	5695868	6279 85 2		237						
GS-OTLGR	Light grey 2000/ ST	5695868	6279 85 2		242	GS-SI70110CW	Cream/ St / FS	5659082	6277 04 1		223

06 LFS_Katalog_2010_Neuer_Stand / en / 22/02/2010 (LLEExport_00995)

Type	Dimensions/Colour/Div.	EAN-C.	Art. no.	Price	Page	Type	Dimensions/Colour/Div.	EAN-C.	Art. no.	Price	Page
				/pc.						/pc.	
GS-SI70110LGR	Light grey/ St / FS	5659099	6277 04 2		223	G-SVS70210CW	Cream/ St	5667797	6279 77 3		259
GS-SI70110RW	Pure white/ St / FS	5659044	6277 04 0		223	G-SVS70210LGR	Light grey/ St	5667803	6279 77 4		253
GS-SI70130CW	Cream/ St / FS	5660330	6277 24 1		228	G-SVS70210LGR	Light grey/ St	5667803	6279 77 4		259
GS-SI70130LGR	Light grey/ St / FS	5660347	6277 24 2		228	G-SVS70210RW	Pure white/ St	5667780	6279 77 2		253
GS-SI70130RW	Pure white/ St / FS	5660323	6277 24 0		228	G-SVS70210RW	Pure white/ St	5667780	6279 77 2		259
GS-SI70170CW	Cream/ St / FS	5662372	6277 64 1		239						
GS-SI70170LGR	Light grey/ St / FS	5662389	6277 64 2		239	G-SVS90110CW	Cream/ St	5667834	6279 77 7		221
GS-SI70170RW	Pure white/ St / FS	5662365	6277 64 0		239	G-SVS90110LGR	Light grey/ St	5667841	6279 77 8		221
						G-SVS90110RW	Pure white/ St	5667827	6279 77 6		221
GS-SI90110CW	Cream/ St / FS	5659747	6277 14 1		223	G-SVS90130CW	Cream/ St	5667872	6279 78 1		226
GS-SI90110LGR	Light grey/ St / FS	5659754	6277 14 2		223	G-SVS90130CW	Cream/ St	5667872	6279 78 1		231
GS-SI90110RW	Pure white/ St / FS	5659709	6277 14 0		223	G-SVS90130LGR	Light grey/ St	5667889	6279 78 2		226
GS-SI90130CW	Cream/ St / FS	5660873	6277 34 1		228	G-SVS90130LGR	Light grey/ St	5667889	6279 78 2		231
GS-SI90130LGR	Light grey/ St / FS	5660880	6277 34 2		228	G-SVS90130RW	Pure white/ St	5667865	6279 78 0		226
GS-SI90130RW	Pure white/ St / FS	5660866	6277 34 0		228	G-SVS90130RW	Pure white/ St	5667865	6279 78 0		231
GS-SI90170CW	Cream/ St / FS	5662716	6277 74 1		239	G-SVS90170CW	Cream/ St	5667919	6279 78 5		237
GS-SI90170LGR	Light grey/ St / FS	5662723	6277 74 2		239	G-SVS90170CW	Cream/ St	5667919	6279 78 5		242
GS-SI90170RW	Pure white/ St / FS	5662709	6277 74 0		239	G-SVS90170CW	Cream/ St	5667919	6279 78 5		248
						G-SVS90170LGR	Light grey/ St	5667926	6279 78 6		242
GS-ST70110CW	Cream/ St / FS	5659167	6277 06 1		223	G-SVS90170LGR	Light grey/ St	5667926	6279 78 6		237
GS-ST70110LGR	Light grey/ St / FS	5659204	6277 06 2		223	G-SVS90170LGR	Light grey/ St	5667926	6279 78 6		248
GS-ST70110RW	Pure white/ St / FS	5659150	6277 06 0		223	G-SVS90170RW	Pure white/ St	5667902	6279 78 4		237
GS-ST70130CW	Cream/ St / FS	5660415	6277 26 1		228	G-SVS90170RW	Pure white/ St	5667902	6279 78 4		242
GS-ST70130LGR	Light grey/ St / FS	5660422	6277 26 2		228	G-SVS90170RW	Pure white/ St	5667902	6279 78 4		248
GS-ST70130RW	Pure white/ St / FS	5660408	6277 26 0		228						
GS-ST70170CW	Cream/ St / FS	5662426	6277 66 1		239	G-SVS90210CW	Cream/ St	5667957	6279 78 9		253
GS-ST70170LGR	Light grey/ St / FS	5662433	6277 66 2		239	G-SVS90210CW	Cream/ St	5667957	6279 78 9		259
GS-ST70170RW	Pure white/ St / FS	5662419	6277 66 0		239	G-SVS90210LGR	Light grey/ St	5667964	6279 79 0		253
						G-SVS90210LGR	Light grey/ St	5667964	6279 79 0		259
GS-ST90110CW	Cream/ St / FS	5659822	6277 16 1		223	G-SVS90210RW	Pure white/ St	5667940	6279 78 8		253
GS-ST90110LGR	Light grey/ St / FS	5659860	6277 16 2		223	G-SVS90210RW	Pure white/ St	5667940	6279 78 8		259
GS-ST90110RW	Pure white/ St / FS	5659815	6277 16 0		223						
GS-ST90130CW	Cream/ St / FS	5660958	6277 36 1		228						
GS-ST90130LGR	Light grey/ St / FS	5660965	6277 36 2		228	HAT30	Blue/ PA	5465249	6290 20 1		331
GS-ST90130RW	Pure white/ St / FS	5660941	6277 36 0		228						
GS-ST90170CW	Cream/ St / FS	5662761	6277 76 1		239						
GS-ST90170LGR	Light grey/ St / FS	5662815	6277 76 2		239	IKR4RW		5616559	6288 36 5		357
GS-ST90170RW	Pure white/ St / FS	5662754	6277 76 0		239						
				/m		IKR6RW	/ PVC	5694915	6288 36 9		357
GS-TW70	2000/ St	5659334	6277 09 0		224						
GS-TW70	2000/ St	5659334	6277 09 0		229						
GS-TW70	2000/ St	5659334	6277 09 0		234					/m	
GS-TW70	2000/ St	5659334	6277 09 0		240	ISS BP3GN	Green 3000	5143987	6286 75 8		318
GS-TW70	2000/ St	5659334	6277 09 0		245	ISS BP3GR	Grey white 3000	5143949	6286 75 4		318
GS-TW70	2000/ St	5659334	6277 09 0		251						
GS-TW70	2000/ St	5659334	6277 09 0		256	ISS BP3RT	Red 3000	5143970	6286 75 6		318
GS-TW70	2000/ St	5659334	6277 09 0		262	ISS BP3SW	Black 3000	5143925	6286 75 0		318
GS-TW90	2000/ St	5659341	6277 09 5		224						
GS-TW90	2000/ St	5659341	6277 09 5		229	ISS BP4SW	Black 4000	5143932	6286 75 2		318
GS-TW90	2000/ St	5659341	6277 09 5		234						
GS-TW90	2000/ St	5659341	6277 09 5		240					/pc.	
GS-TW90	2000/ St	5659341	6277 09 5		245	ISS110100FEL	/ AI / EL	5477402	6289 04 3		328
GS-TW90	2000/ St	5659341	6277 09 5		251	ISS110100FRW	Pure white/ AI	5477013	6289 04 0		328
GS-TW90	2000/ St	5659341	6277 09 5		256	ISS110100REL	/ AI / EL	5477426	6289 06 3		327
GS-TW90	2000/ St	5659341	6277 09 5		262	ISS110100RRW	Pure white/ AI	5477037	6289 06 0		327
				/pc.							
G-SVS70110CW	Cream/ St	5667674	6279 76 1		221	ISS120 245EL	2450/ AI / EL	5142607	6286 00 3		318
G-SVS70110LGR	Light grey/ St	5667681	6279 76 2		221	ISS120 245RW	Pure white 2450/ AI	5142560	6286 00 0		318
G-SVS70110RW	Pure white/ St	5667667	6279 76 0		221						
G-SVS70130CW	Cream/ St	5667711	6279 76 5		226	ISS120 300EL	3000/ AI / EL	5143017	6286 11 3		318
G-SVS70130CW	Cream/ St	5667711	6279 76 5		231	ISS120 300RW	Pure white 3000/ AI	5142980	6286 11 0		318
G-SVS70130LGR	Light grey/ St	5667728	6279 76 6		226	ISS120 310EL	3100/ AI / EL	5143086	6286 13 3		318
G-SVS70130LGR	Light grey/ St	5667728	6279 76 6		231	ISS120 310RW	Pure white 3100/ AI	5143079	6286 13 0		318
G-SVS70130RW	Pure white/ St	5667704	6279 76 4		226	ISS120 325EL	3250/ AI / EL	5143192	6286 16 3		318
G-SVS70130RW	Pure white/ St	5667704	6279 76 4		231	ISS120 325RW	Pure white 3250/ AI	5143161	6286 16 0		318
G-SVS70170CW	Cream/ St	5667759	6279 76 9		237	ISS120 330EL	3300/ AI / EL	5143222	6286 17 3		318
G-SVS70170CW	Cream/ St	5667759	6279 76 9		242	ISS120 330RW	Pure white 3300/ AI	5143208	6286 17 0		318
G-SVS70170CW	Cream/ St	5667759	6279 76 9		248	ISS120 340EL	3400/ AI / EL	5143314	6286 19 3		318
G-SVS70170LGR	Light grey/ St	5667766	6279 77 0		237	ISS120 340RW	Pure white 3400/ AI	5143284	6286 19 0		318
G-SVS70170LGR	Light grey/ St	5667766	6279 77 0		242	ISS120 345EL	3450/ AI / EL	5143338	6286 20 3		318
G-SVS70170LGR	Light grey/ St	5667766	6279 77 0		248	ISS120 345RW	Pure white 3450/ AI	5143321	6286 20 0		318
G-SVS70170RW	Pure white/ St	5667742	6279 76 8		237	ISS120 355EL	3550/ AI / EL	5143406	6286 22 3		318
G-SVS70170RW	Pure white/ St	5667742	6279 76 8		242	ISS120 355RW	Pure white 3550/ AI	5143383	6286 22 0		318
G-SVS70170RW	Pure white/ St	5667742	6279 76 8		248	ISS120 370EL	3700/ AI / EL	5143499	6286 25 3		318
G-SVS70170RW	Pure white/ St	5667742	6279 76 8		248	ISS120 370RW	Pure white 3700/ AI	5143451	6286 25 0		318
						ISS120 395EL	3950/ AI / EL	5143574	6286 29 3		318
G-SVS70210CW	Cream/ St	5667797	6279 77 3		253	ISS120 395RW	Pure white 3950/ AI	5143567	6286 29 0		318

Type listing

Structure of the EAN number: Country code **40**

Manufacturer code **1219** (for articles beginning with **0: 1010**)

Individual EAN-C **5647589**

Type	Dimensions/Colour/Div.	EAN-C.	Art. no.	Price	Page	Type	Dimensions/Colour/Div.	EAN-C.	Art. no.	Price	Page
				/pc.						/pc.	
ISS120DDF7035	Light grey/ ST	5144007	6286 77 2		318	ISSO70140EL	/ AI / EL	5160601	6288 92 3		320
ISS120DDF9010	Pure white/ ST	5143994	6286 77 0		318	ISSO70140RW	Pure white/ AI	5160564	6288 92 0		320
ISS120DDF9011RW	Graphite black/ ST	5144038	6286 77 5		318	ISSRGU	Black/ GUM	5428152	6290 17 8		326
ISS140100FEL	/ AI / EL	5477020	6289 05 3		329	ISSRHSM45EL	/ AI / EL	5428145	6290 09 1		334
ISS140100FRW	Pure white/ AI	5477419	6289 05 0		329	ISSRHSM45RW	Pure white/ AI	5428138	6290 09 0		334
ISS140100REL	/ AI / EL	5477044	6289 07 3		329	ISSRM45EL	/ AI / EL	5428107	6290 08 7		325
ISS140100RRW	Pure white/ AI	5477433	6289 07 0		329	ISSRM45FEL	/ AI / EL	5428084	6290 08 3		326
ISS140110EL	/ AI / EL	5160908	6288 96 3		324	ISSRM45FRW	Pure white/ AI	5428077	6290 08 2		326
ISS140110RW	Pure white/ AI	5160861	6288 96 0		324	ISSRM45RW	Pure white/ AI	5428091	6290 08 6		325
ISS140220EL	/ AI / EL	5160977	6288 97 3		325	ISSSF	Chrome black/ ST	5161981	6290 18 0		331
ISS140220RW	Pure white/ AI	5160960	6288 97 0		325	ISST70140BEL	/ AI / EL	5161219	6290 01 3		321
ISS70110EL	/ AI / EL	5160748	6288 94 3		322	ISST70140BRW	Pure white/ AI	5161202	6290 01 0		321
ISS70110RW	Pure white/ AI	5160731	6288 94 0		322	ISST70140EL	/ AI / EL	5160670	6288 93 3		319
ISS90110EL	/ AI / EL	5160847	6288 95 3		323	ISST70140RW	Pure white/ AI	5160663	6288 93 0		319
ISS90110RW	Pure white/ AI / EL	5160809	6288 95 0		323	ISSZ70140	Pure white/ ST / FSK	5161868	6290 16 0		319
ISS98 61OT3RW	Pure white/ ST	5143765	6286 55 0		316	ISSZ70140	Pure white/ ST / FSK	5161868	6290 16 0		321
ISS98 71OT3KRW	Pure white/ ST	5143819	6286 56 0		316	KA-ZKB AL1	Aluminium paint	5677888	6117 98 7		348
ISS98B	Pure white/ PVC	5144045	6286 80 0		316	KA-ZKB RW1	Pure white	5677864	6117 98 5		348
ISS98KF	/ ST / FS	5144052	6286 80 2		317	KA-ZKB SWGR1	Black-grey	5677871	6117 98 6		348
ISSAH	/ AI / EL	5162001	6290 18 4		331						
ISSBP140110RW	Pure white/ ST / FSK	5161752	6290 13 0		324						
ISSBP140110WAW	White aluminium/ ST / FSK	5161769	6290 13 4		324						
ISSBP70110RW	Pure white/ ST / FSK	5161578	6290 10 0		322	KG2CW	Cream/ AI	5146582	6287 70 1	/m	307
ISSBP70110WAW	White aluminium/ ST / FSK	5161585	6290 10 4		322	KG2CW	Cream/ AI	5146674	6287 71 1		307
ISSBP70140RW	Pure white/ ST / FSK	5161691	6290 12 0		319	KG2EL	/ AI / EL	5146704	6287 72 3		307
ISSBP70140RW	Pure white/ ST / FSK	5161691	6290 12 0		320	KG2EL	/ AI / EL	5146742	6287 73 3		307
ISSBP70140RW	Pure white/ ST / FSK	5161691	6290 12 0		321	KG2LGR	Light grey/ AI	5146612	6287 70 2		307
ISSBP70140WAW	White aluminium/ ST / FSK	5161707	6290 12 4		319	KG2LGR	Light grey/ AI	5146681	6287 71 2		307
ISSBP70140WAW	White aluminium/ ST / FSK	5161707	6290 12 4		320	KG2RW	Pure white/ AI	5146575	6287 70 0		307
ISSBP70140WAW	White aluminium/ ST / FSK	5161707	6290 12 4		321	KG2RW	Pure white/ AI	5146643	6287 71 0		307
ISSBP90110RW	Pure white/ ST	5161639	6290 11 0		323						
ISSBP90110WAW	White aluminium/ ST	5161646	6290 11 4		323						
ISSBW70140RW	Pure white/ ST / FSK	5161813	6290 15 0		319						
ISSBW70140RW	Pure white/ ST / FSK	5161813	6290 15 0		321	KL80A	/ PA	5148777	6288 64 0	/pc.	210
ISSGU140110	Black/ GUM	5161943	6290 17 6		324	KL80A	/ PA	5148777	6288 64 0		213
ISSGU70110	Black/ GUM	5161882	6290 17 0		322	KL80A	/ PA	5148777	6288 64 0		216
ISSGU70140	Black/ GUM	5161936	6290 17 4		319	KL80A	/ PA	5148777	6288 64 0		224
ISSGU70140	Black/ GUM	5161936	6290 17 4		320	KL80A	/ PA	5148777	6288 64 0		229
ISSGU70140	Black/ GUM	5161936	6290 17 4		321	KL80A	/ PA	5148777	6288 64 0		234
ISSGU90110	Black/ GUM	5161929	6290 17 2		323	KL80A	/ PA	5148777	6288 64 0		240
ISSHS140250EL	/ AI / EL	5161264	6290 02 3		333	KL80A	/ PA	5148777	6288 64 0		245
ISSHS140250RW	Pure white/ AI	5161226	6290 02 0		333	KL80A	/ PA	5148777	6288 64 0		251
ISSHS140500EL	Aluminium/ AI / EL	5161325	6290 03 3		333	KL80A	/ PA	5148777	6288 64 0		256
ISSHS140500RW	Pure white/ AI	5161288	6290 03 0		333	KNW1	150 Black/ POM	6014514	6178 52 7		184
ISSHS140700EL	Aluminium/ AI / EL	5161387	6290 04 3		333	KNW2	150 Black/ POM	6014637	6178 52 9		184
ISSHS140700RW	Pure white/ AI	5161349	6290 04 0		333						
ISSHS2D120EL	/ AI / EL	5143758	6286 50 3		334	KS70110	/ St / FS	5680697	6279 80 2		304
ISSHS2D120LGR	Light grey/ AI	5143741	6286 50 2		334	KS70130	/ St / FS	5680703	6279 80 4		304
ISSHS2D120RW	Pure white/ AI	5143734	6286 50 0		334	KS70170	/ St / FS	5680734	6279 80 6		304
ISSHS4 61OT3LGR	Light grey/ ST	5143918	6286 70 2		332	KS990GN1-0	Mint green	5404392	6288 61 7		355
ISSHS4 61OT3RW	Pure white/ ST	5143888	6286 70 0		332	KS990GN2-0	Mint green	5404422	6288 62 0		355
ISSHS4SR40	Graphite black/ ST	5144090	6286 81 0		332	KS990GN3-0	Mint green	5404453	6288 62 3		356
ISSHS6RW	/ AI / EL	5161561	6290 07 3		334	KS990RT1-0	Signal red	5404408	6288 61 8		355
ISSHSO270140EL	/ AI / EL	5161516	6290 06 3		333	KS990RT2-0	Signal red	5404439	6288 62 1		355
ISSHSO270140RW	Pure white/ AI	5161509	6290 06 0		333						
ISSHSO70140EL	/ AI / EL	5161455	6290 05 3		333						
ISSHSO70140RW	Pure white/ AI	5161448	6290 05 0		333						

06 LFS_Katalog_2010_Neuer_Stand / en / 22/02/2010 (LLEExport_00995)

Type	Dimensions/Colour/Div.	EAN-C.	Art. no.	Price	Page	Type	Dimensions/Colour/Div.	EAN-C.	Art. no.	Price	Page
KS990RT3-0	Signal red	5404460	6288 62 4	/pc.	356	LK4 15015	Stone grey 2000/ PVC	6000050	6178 00 1	/m	164
KS990RW1-0	Pure white	5404385	6288 61 6		355	LK4 30015	Stone grey 2000/ PVC	6000173	6178 00 3		164
KS990RW2-0	Pure white	5404415	6288 61 9		355	LK4 30025	Stone grey 2000/ PVC	6000296	6178 00 5		164
KS990RW3-0	Pure white	5404446	6288 62 2		356	LK4 40025	Stone grey 2000/ PVC	6000418	6178 01 0		164
KS-B AL1	Aluminium paint	5405931	6117 63 8		345	LK4 40040	Stone grey 2000/ PVC	6000531	6178 01 2		165
KS-B RW1	Pure white	5405924	6117 63 7		345	LK4 40060	Stone grey 2000/ PVC	6000654	6178 01 4		165
KS-B SWGR1	Black-grey	5701064	6117 63 9		345	LK4 40080	Stone grey 2000/ PVC	6000777	6178 01 6		165
						LK4 40100	Stone grey 2000/ PVC	6000890	6178 01 8		165
KSB990GN1-0	Mint green	5404484	6288 62 6		356	LK4 60015	Stone grey 2000/ PVC	6001132	6178 02 6		166
KSB990GN2-0	Mint green	5404514	6288 62 9		356						
KSB990GN3-0	Mint green	5404545	6288 63 2		356	LK4 60025	Stone grey 2000/ PVC	6001255	6178 02 8		166
KSB990RT1-0	Signal red	5404491	6288 62 7		356	LK4 60040	Stone grey 2000/ PVC	6001378	6178 03 1		166
KSB990RT2-0	Signal red	5404521	6288 63 0		356						
KSB990RT3-0	Signal red	5404552	6288 63 3		356	LK4 60060	Stone grey 2000/ PVC	6001491	6178 03 3		166
KSB990RW1-0	Pure white	5404477	6288 62 5		356	LK4 60080	Stone grey 2000/ PVC	6001613	6178 03 5		167
KSB990RW2-0	Pure white	5404507	6288 62 8		356						
KSB990RW3-0	Pure white	5404538	6288 63 1		356	LK4 60100	Stone grey 2000/ PVC	6001736	6178 03 7		167
KSN1	Light grey 4,5/ PP	6014279	6178 52 0		184	LK4 60120	Stone grey 2000/ PVC	6001859	6178 03 9		167
						LK4 80025	Stone grey 2000/ PVC	6002214	6178 05 0		167
KSN2	Light grey 6/ PP	6014392	6178 52 2		184	LK4 80040	Stone grey 2000/ PVC	6002337	6178 05 2		168
						LK4 80060	Stone grey 2000/ PVC	6002450	6178 05 4		168
KSP170	152/ St / FS	5680741	6279 81 0	/pc.	304	LK4 80080	Stone grey 2000/ PVC	6002573	6178 05 6		168
KSP210	192/ St / FS	5680758	6279 81 2		304	LK4 80100	Stone grey 2000/ PVC	6002696	6178 05 9		168
KSR20020	Grey 28/ PE	6018598	6249 84 2		138	LK4 80120	Stone grey 2000/ PVC	6002818	6178 06 1		169
KSR20030	Grey 34/ PE	6018710	6249 84 4		139	LK4 D 100	Stone grey 100/ PVC	6040803	6178 49 0		165
						LK4 D 100	Stone grey 100/ PVC	6040803	6178 49 0		167
						LK4 D 100	Stone grey 100/ PVC	6040803	6178 49 0		168
						LK4 D 100	Stone grey 100/ PVC	6040803	6178 49 0		171
KSR30030	Grey 34/ PE	5691020	6249 84 5		140	LK4 D 100	Stone grey 100/ PVC	6040803	6178 49 0		172
						LK4 D 100	Stone grey 100/ PVC	6040803	6178 49 0		172
KSR40040	Grey 47,7/ PE	6018833	6249 84 6		142	LK4 D 120	Stone grey 120/ PVC	6040926	6178 49 2		167
						LK4 D 120	Stone grey 120/ PVC	6040926	6178 49 2		169
KSR40060	Grey 47/ PE	6018956	6249 84 8		144	LK4 D 120	Stone grey 120/ PVC	6040926	6178 49 2		171
						LK4 D 120	Stone grey 120/ PVC	6040926	6178 49 2		173
KSR60060	Grey 67,7/ PE	6019076	6249 85 0		146						
KSR60100	Grey 104/ PE	5020325	6249 85 2		148	LK4 D 15	Stone grey 15/ PVC	6040209	6178 48 0		164
						LK4 D 15	Stone grey 15/ PVC	6040209	6178 48 0		166
						LK4 D 15	Stone grey 15/ PVC	6040209	6178 48 0		170
KSR60150	Grey 154/ PE	5020387	6249 85 4		150	LK4 D 25	Stone grey 25/ PVC	6040322	6178 48 2		164
						LK4 D 25	Stone grey 25/ PVC	6040322	6178 48 2		164
KSR60200	Grey 204/ PE	5020394	6249 85 6		152	LK4 D 25	Stone grey 25/ PVC	6040322	6178 48 2		166
						LK4 D 25	Stone grey 25/ PVC	6040322	6178 48 2		167
						LK4 D 25	Stone grey 25/ PVC	6040322	6178 48 2		170
						LK4 D 25	Stone grey 25/ PVC	6040322	6178 48 2		171
KSR80080	Grey 84/ PE	5691037	6249 86 5		154	LK4 D 25	Stone grey 25/ PVC	6040322	6178 48 2		170
						LK4 D 25	Stone grey 25/ PVC	6040322	6178 48 2		171
KUPA	55/ V2A	5148913	6288 66 7		266	LK4 D 40	Stone grey 40/ PVC	6040445	6178 48 4		165
KUPA	55/ V2A	5148913	6288 66 7		269	LK4 D 40	Stone grey 40/ PVC	6040445	6178 48 4		166
KUPA	55/ V2A	5148913	6288 66 7		272	LK4 D 40	Stone grey 40/ PVC	6040445	6178 48 4		168
KUPA	55/ V2A	5148913	6288 66 7		275	LK4 D 40	Stone grey 40/ PVC	6040445	6178 48 4		170
KUPA	55/ V2A	5148913	6288 66 7		278	LK4 D 40	Stone grey 40/ PVC	6040445	6178 48 4		172
KUPA	55/ V2A	5148913	6288 66 7		281						
KUPA	55/ V2A	5148913	6288 66 7		284	LK4 D 60	Stone grey 60/ PVC	6040568	6178 48 6		165
KUPA	55/ V2A	5148913	6288 66 7		287	LK4 D 60	Stone grey 60/ PVC	6040568	6178 48 6		166
KUPA	55/ V2A	5148913	6288 66 7		290	LK4 D 60	Stone grey 60/ PVC	6040568	6178 48 6		168
KUPA	55/ V2A	5148913	6288 66 7		293	LK4 D 60	Stone grey 60/ PVC	6040568	6178 48 6		170
KUPA	55/ V2A	5148913	6288 66 7		296	LK4 D 60	Stone grey 60/ PVC	6040568	6178 48 6		172
KUPA	55/ V2A	5148913	6288 66 7		299						
KVV	Pure white/ ST	5733195	9002 09 7		307	LK4 D 80	Stone grey 80/ PVC	6040681	6178 48 8		165
						LK4 D 80	Stone grey 80/ PVC	6040681	6178 48 8		167
						LK4 D 80	Stone grey 80/ PVC	6040681	6178 48 8		168
						LK4 D 80	Stone grey 80/ PVC	6040681	6178 48 8		171
						LK4 D 80	Stone grey 80/ PVC	6040681	6178 48 8		172

Type listing

Structure of the EAN number: Country code 40

Manufacturer code 1219 (for articles beginning with 0: 1010)

Individual EAN-C 5647589

Type	Dimensions/Colour/Div.	EAN-C.	Art. no.	Price	Page	Type	Dimensions/Colour/Div.	EAN-C.	Art. no.	Price	Page
LK4 DM 15	Stone grey 15/ PVC	5049531	6178 47 9	/m	164	LKM F80080FS	240/ ST / FS	5699026	6248 32 8	/pc.	153
						LKM F80080RW	Pure white 240/ ST / FSK	5699095	6248 42 8		153
LK4 H	Stone grey 56/ PS	6008339	6178 09 2	/100 pc.	184						
LK4 N 60015	Stone grey 2000/ PVC	6004850	6178 20 1	/m	170	LKM I40040FS	160/ ST / FS	6652150	6247 65 2		141
LK4 N 60025	Stone grey 2000/ PVC	6004973	6178 20 3		170	LKM I40040RW	Pure white 160/ ST / FSK	6652211	6249 16 7		141
LK4 N 60040	Stone grey 2000/ PVC	6005093	6178 20 5		170	LKM I40060FS	160/ ST / FS	6313150	6247 66 0		143
LK4 N 60060	Stone grey 2000/ PVC	6005215	6178 20 7		170	LKM I40060RW	Pure white 160/ ST / FSK	6314478	6249 17 5		143
LK4 N 60080	Stone grey 2000/ PVC	6005307	6178 20 9		171	LKM I60060FS	180/ ST / FS	6977185	6248 12 8		145
LK4 N 60100	Stone grey 2000/ PVC	6005406	6178 21 1		171	LKM I60060RW	Pure white 180/ ST / FSK	6977123	6249 61 2		145
LK4 N 60120	Stone grey 2000/ PVC	6005505	6178 21 3		171	LKM I60100FS	180/ ST / FS	6313396	6248 14 4		147
						LKM I60100RW	Pure white 180/ ST / FSK	6315079	6249 63 9		147
LK4 N 80025	Stone grey 2000/ PVC	6005802	6178 22 5		171	LKM I60150FS	180/ ST / FS	6313457	6248 15 2		149
LK4 N 80040	Stone grey 2000/ PVC	6005932	6178 22 7		172	LKM I60150RW	Pure white 180/ ST / FSK	6315130	6249 64 7		149
LK4 N 80060	Stone grey 2000/ PVC	6006052	6178 22 9		172						
LK4 N 80080	Stone grey 2000/ PVC	6006175	6178 23 1		172	LKM I60200FS	180/ ST / FS	6313518	6248 16 0		151
LK4 N 80100	Stone grey 2000/ PVC	6006298	6178 23 3		172	LKM I60200RW	Pure white 180/ ST / FSK	6315192	6249 65 5		151
LK4 N 80120	Stone grey 2000/ PVC	6006410	6178 23 6		173						
LKM A40040FS	160/ ST / FS	6652273	6247 56 3	/pc.	141	LKM I80080FS	160/ ST / FS	5699040	6248 33 6		153
LKM A40040RW	Pure white 160/ ST / FSK	6652334	6249 08 6		141	LKM I80080RW	Pure white 160/ ST / FSK	5699118	6248 43 6		153
LKM A40060FS	160/ ST / FS	6312733	6247 57 1		143						
LKM A40060RW	Pure white 160/ ST / FSK	6314232	6249 09 4		143	LKM K140	25 140/ ST / FS	6119295	6249 88 8	/100 pc.	155
LKM A60060FS	180/ ST / FS	6977062	6248 04 7		145	LKM K80	25 80/ ST / FS	6119233	6249 88 4		155
LKM A60060RW	Pure white 180/ ST / FSK	6503650	6249 55 8		145						
LKM A60100FS	180/ ST / FS	6312979	6248 06 3		147	LKM KF 60100	/ St / FS	5685081	6249 88 1	/pc.	148
LKM A60100RW	Pure white 180/ ST / FSK	6314898	6249 57 4		147						
LKM A60150FS	180/ ST / FS	6313037	6248 07 1		149	LKM SV20	45 19,7/ ST / G	6652754	6247 43 1		138
LKM A60150RW	Pure white 180/ ST / FSK	6314959	6249 58 2		149	LKM SV30	53,8 29,5/ ST / G	6118991	6247 43 4		139
LKM A60200FS	180/ ST / FS	6313099	6248 09 8		151	LKM SV30	53,8 29,5/ ST / G	6118991	6247 43 4		140
LKM A60200RW	Pure white 180/ ST / FSK	6315017	6249 59 0		151	LKM SV40	76 29,6/ V2A	6315253	6247 45 8		141
						LKM SV40	76 29,6/ V2A	6315253	6247 45 8		143
LKM A80080FS	200/ ST / FS	5699033	6248 33 2		153	LKM SV60	75 50/ V2A	6315314	6247 46 6		145
LKM A80080RW	Pure white 200/ ST / FSK	5699101	6248 43 2		153	LKM SV60	75 50/ V2A	6315314	6247 46 6		147
						LKM SV60	75 50/ V2A	6315314	6247 46 6		149
LKM E40040FS	40/ ST / FS	6652631	6247 88 1		141	LKM SV60	75 50/ V2A	6315314	6247 46 6		151
LKM E40040RW	Pure white 40/ ST / FSK	6652693	6249 41 8		141						
LKM E40060FS	60/ ST / FS	6575114	6247 90 3		144	LKM SV80	75 65,6/ ST	5699019	6247 47 2		153
LKM E40060RW	Pure white 60/ ST / FSK	6575350	6249 42 6		144						
LKM E60060FS	63/ ST / FS	6503353	6248 28 4		145	LKM T40040FS	280/ ST / FS	6652396	6247 72 5		141
LKM E60060RW	Pure white 63/ ST / FSK	6503292	6249 79 5		145	LKM T40040RW	Pure white 280/ ST / FSK	6652457	6249 25 6		141
LKM E60100FS	100/ ST / FS	6575596	6248 30 6		147	LKM T40060FS	300/ ST / FS	6317592	6247 73 3		143
LKM E60100RW	Pure white 100/ ST / FSK	6575770	6249 81 7		147	LKM T40060RW	Pure white 300/ ST / FSK	6318018	6249 26 4		143
LKM E60150FS	150/ ST / FS	6575657	6248 31 4		149	LKM T60060FS	300/ ST / FS	6503599	6248 18 7		145
LKM E60150RW	Pure white 150/ ST / FSK	6575831	6249 82 5		149	LKM T60060RW	Pure white 300/ ST / FSK	6503537	6249 67 1		145
LKM E60200FS	200/ ST / FS	6575718	6248 32 2		151	LKM T60100FS	340/ ST / FS	6317837	6248 20 9		147
LKM E60200RW	Pure white 200/ ST / FSK	6575893	6249 83 3		151	LKM T60100RW	Pure white 340/ ST / FSK	6318254	6249 70 1		147
						LKM T60150FS	390/ ST / FS	6317899	6248 21 7		149
LKM E80080FS	80/ ST / FS	5699064	6248 34 4		153	LKM T60150RW	Pure white 390/ ST / FSK	6318315	6249 72 8		149
LKM E80080RW	Pure white 80/ ST / FSK	5699156	6248 45 4		153	LKM T60200FS	440/ ST / FS	6317950	6248 22 5		151
						LKM T60200RW	Pure white 440/ ST / FSK	6318377	6249 73 6		151
LKM F40040FS	160/ ST / FS	6652518	6247 49 0		141						
LKM F40040RW	Pure white 160/ ST / FSK	6652570	6248 99 3		141	LKM T80080FS	300/ ST / FS	5699057	6248 34 0		153
LKM F40060FS	180/ ST / FS	6312313	6247 50 4		143	LKM T80080RW	Pure white 300/ ST / FSK	5699125	6248 45 0		153
LKM F40060RW	Pure white 180/ ST / FSK	6313990	6249 00 0		143						
LKM F60060FS	180/ ST / FS	6503476	6247 98 9		145						
LKM F60060RW	Pure white 180/ ST / FSK	6503414	6249 48 5		145	LKM TWS55	2000 55/ ST / FS	6644896	6249 87 6	/m	155
LKM F60100FS	220/ ST / FS	6312559	6248 00 4		147						
LKM F60100RW	Pure white 220/ ST / FSK	6314713	6249 50 7		147	LKM Z100	96 30/ ST / FS	6315499	6249 92 2	/pc.	155
LKM F60150FS	270/ ST / FS	6312610	6248 01 2		149	LKM Z150	146 30/ ST / FS	6315611	6249 96 5		155
LKM F60150RW	Pure white 270/ ST / FSK	6314775	6249 51 5		149	LKM Z200	166 30/ ST / FS	6315673	6249 98 1		155
LKM F60200FS	320/ ST / FS	6312672	6248 02 0		151						
LKM F60200RW	Pure white 320/ ST / FSK	6314836	6249 52 3		151						

06 LFS_Katalog_2010_Neuer_Stand / en / 22/02/2010 (LLEXPOR_00995)

Type	Dimensions/Colour/Div.	EAN-C.	Art. no.	Price	Page	Type	Dimensions/Colour/Div.	EAN-C.	Art. no.	Price	Page
LKM Z60	46 30/ ST / FS	6315376	6249 90 6	/pc.	143	LKV D 25	Stone grey 25/ PVC	6041282	6178 50 4	/m	174
LKM Z60	46 30/ ST / FS	6315376	6249 90 6		155	LKV D 25	Stone grey 25/ PVC	6041282	6178 50 4		174
LKM20020FS	2000/ ST / FS	6651672	6246 96 6	/m	138	LKV D 25	Stone grey 25/ PVC	6041282	6178 50 4		175
LKM20020RW	Pure white 2000/ ST / FSK	6651795	6248 46 2		138	LKV D 25	Stone grey 25/ PVC	6041282	6178 50 4		179
LKM20030FS	2000/ ST / FS	6118878	6246 97 4		139	LKV D 37	Stone grey 37,5/ PVC	6041404	6178 50 6		174
LKM20030RW	Pure white 2000/ ST / FSK	6119059	6248 47 0		139	LKV D 37	Stone grey 37,5/ PVC	6041404	6178 50 6		175
LKM30030FS	2000/ ST / FS	5690955	6246 98 2		140	LKV D 37	Stone grey 37,5/ PVC	6041404	6178 50 6		176
LKM30030RW	Pure white 2000/ ST / FS	5690962	6248 48 2		140	LKV D 37	Stone grey 37,5/ PVC	6041404	6178 50 6		177
LKM40040FS	2000/ ST / FS	6651733	6246 99 0		141	LKV D 50	Stone grey 50/ PVC	6041527	6178 50 8		175
LKM40040RW	Pure white 2000/ ST / FSK	6651856	6248 49 7		141	LKV D 50	Stone grey 50/ PVC	6041527	6178 50 8		176
LKM40060FS	2000/ ST / FS	6311897	6247 01 6		143	LKV D 50	Stone grey 50/ PVC	6041527	6178 50 8		177
LKM40060RW	Pure white 2000/ ST / FSK	6313570	6248 51 9		143	LKV D 50	Stone grey 50/ PVC	6041527	6178 50 8		179
LKM60060FS	2000/ ST / FS	6977369	6247 09 1		145	LKV D 75	Stone grey 75/ PVC	6041640	6178 51 0		175
LKM60060RW	Pure white 2000/ ST / FSK	6977307	6248 60 8		145	LKV D 75	Stone grey 75/ PVC	6041640	6178 51 0		176
LKM60100FS	2000/ ST / FS	6312139	6247 11 3		147	LKV D 75	Stone grey 75/ PVC	6041640	6178 51 0		177
LKM60100RW	Pure white 2000/ ST / FSK	6313815	6248 62 4		147	LKV D 75	Stone grey 75/ PVC	6041640	6178 51 0		179
LKM60150CRW	Pure white 2000/ ST / FSK	6313877	6248 64 0		149	LKV D 75	Stone grey 75/ PVC	6041640	6178 51 0	/100 pc.	181
LKM60150FS	2000/ ST / FS	6312191	6247 14 8		149	LKV H	Stone grey 56/ PS	6011285	6178 34 9		184
LKM60200FS	2000/ ST / FS	6312252	6247 16 4		151	LKV H 50037	Light grey 2000/ PPO	6016266	6178 61 2	/m	182
LKM60200RW	Pure white 2000/ ST / FSK	6313938	6248 66 7		151	LKV H 50050	Light grey 2000/ PPO	6016389	6178 61 4		182
LKM80080FS	2000/ ST / FS	5691006	6247 19 4		153	LKV H 50075	Light grey 2000/ PPO	6016501	6178 61 6		182
LKM80080RW	Pure white 2000/ ST / FS	5691013	6248 69 4		153	LKV H 75037	Light grey 2000/ PPO	6016747	6178 62 2		182
LKV 100100	Stone grey 2000/ PVC	6011162	6178 34 1		178	LKV H 75050	Light grey 2000/ PPO	6016860	6178 62 4		182
LKV 10037	Stone grey 2000/ PVC	6010806	6178 33 4		177	LKV H 75075	Light grey 2000/ PPO	6016983	6178 62 6		182
LKV 10050	Stone grey 2000/ PVC	6010929	6178 33 6		177	LKV H 75100	Light grey 2000/ PPO	6017102	6178 62 8		182
LKV 10075	Stone grey 2000/ PVC	6011049	6178 33 8		177	LKV H 75125	Light grey 2000/ PPO	6017225	6178 63 0		183
LKV 25025	Stone grey 2000/ PVC	6009411	6178 30 2		174	LKV H H	Light grey 56/ PS	6017829	6178 65 0	/100 pc.	184
LKV 37025	Stone grey 2000/ PVC	6009534	6178 30 5		174	LKV N 100100	Stone grey 2000/ PVC	6015184	6178 44 1	/m	181
LKV 37037	Stone grey 2000/ PVC	6009657	6178 30 7		174	LKV N 10037	Stone grey 2000/ PVC	6013913	6178 43 5		180
LKV 50025	Stone grey 2000/ PVC	6009732	6178 31 0		174	LKV N 10050	Stone grey 2000/ PVC	6014033	6178 43 7		180
LKV 50037	Stone grey 2000/ PVC	6009831	6178 31 2		175	LKV N 10075	Stone grey 2000/ PVC	6014156	6178 43 9		181
LKV 50050	Stone grey 2000/ PVC	6009930	6178 31 4		175	LKV N 75025	Stone grey 2000/ PVC	6013197	6178 42 0		179
LKV 50075	Stone grey 2000/ PVC	6010073	6178 31 6		175	LKV N 75037	Stone grey 2000/ PVC	6013319	6178 42 2		179
LKV 75025	Stone grey 2000/ PVC	6010196	6178 32 0		175	LKV N 75050	Stone grey 2000/ PVC	6013432	6178 42 4		179
LKV 75037	Stone grey 2000/ PVC	6010318	6178 32 2		176	LKV N 75075	Stone grey 2000/ PVC	6013555	6178 42 6		179
LKV 75050	Stone grey 2000/ PVC	6010400	6178 32 4		176	LKV N 75100	Stone grey 2000/ PVC	6013678	6178 42 8		180
LKV 75075	Stone grey 2000/ PVC	6010509	6178 32 6		176	LKV N 75125	Stone grey 2000/ PVC	6013791	6178 43 0		180
LKV 75100	Stone grey 2000/ PVC	6010608	6178 32 8		176	MVKG70130	110/ St / FS	5680765	6279 82 0	/pc.	305
LKV 75125	Stone grey 2000/ PVC	6010707	6178 33 0		177	MVKG70170	150/ St / FS	5680796	6279 82 2		305
LKV D 100	Stone grey 100/ PVC	6041763	6178 51 2		176	MVKG70210	190/ St / FS	5680802	6279 82 4		305
LKV D 100	Stone grey 100/ PVC	6041763	6178 51 2		178	MVKG90130	110/ St / FS	5680819	6279 82 6		305
LKV D 100	Stone grey 100/ PVC	6041763	6178 51 2		180	MVKG90170	150/ St / FS	5680826	6279 82 8		305
LKV D 100	Stone grey 100/ PVC	6041763	6178 51 2		181	MVKG90210	190/ St / FS	5680857	6279 83 0		305
LKV D 125	Stone grey 125/ PVC	6041886	6178 51 4		177	MVKV70130	/ St / FS	5680864	6279 83 2		306
LKV D 125	Stone grey 125/ PVC	6041886	6178 51 4		180	MVKV70170	/ St / FS	5680871	6279 83 4		306
LKV D 25	Stone grey 25/ PVC	6041282	6178 50 4		174	MVKV70210	/ St / FS	5680888	6279 83 6		306
						MVKV90130	/ St / FS	5680895	6279 83 8		306
						MVKV90170	/ St / FS	5680901	6279 84 0		306
						MVKV90210	/ St / FS	5680918	6279 84 2		306

Type listing

Structure of the EAN number: Country code **40**

Manufacturer code **1219** (for articles beginning with **0: 1010**)

Individual EAN-C **5647589**

Type	Dimensions/Colour/Div.	EAN-C.	Art. no.	Price	Page	Type	Dimensions/Colour/Div.	EAN-C.	Art. no.	Price	Page
OK-K 45	/ V2A	6176236	6116 11 6	/pc.	188	PVV N2 500	500	5297253	6288 08 4	/pc.	306
OK-K 45	/ V2A	6176236	6116 11 6		191	PVV N2 525	525	5297260	6288 08 6		306
						PVV N2 550	550	5146988	6288 04 6		306
						PVV N2 575	575	5146995	6288 04 8		306
OT3V GEKA50EL	/ AI / EL	5157625	6287 16 3	/m	291						
OT3V GEKA50EL	/ AI / EL	5157625	6287 16 3		294	PVV N2 600	600	5147008	6288 05 0		306
OT3V GEKA50RW	Pure white/ AI	5157618	6287 16 0		291	PVV N2 625	625	5147039	6288 05 2		306
OT3V GEKA50RW	Pure white/ AI	5157618	6287 16 0		294	PVV N2 650	650	5147046	6288 05 4		306
OT3V GEKA80EL	/ AI / EL	5145196	6287 17 3		266	PVV N2 675	675	5147053	6288 05 6		306
OT3V GEKA80EL	/ AI / EL	5145196	6287 17 3		269						
OT3V GEKA80EL	/ AI / EL	5145196	6287 17 3		272	PVV N2 700	700	5147060	6288 05 8		306
OT3V GEKA80EL	/ AI / EL	5145196	6287 17 3		275	PVV N2 725	725	5147091	6288 06 0		306
OT3V GEKA80EL	/ AI / EL	5145196	6287 17 3		278	PVV N2 750	750	5147107	6288 06 2		306
OT3V GEKA80EL	/ AI / EL	5145196	6287 17 3		281	PVV N2 775	775	5297277	6288 08 8		306
OT3V GEKA80EL	/ AI / EL	5145196	6287 17 3		284						
OT3V GEKA80EL	/ AI / EL	5145196	6287 17 3		287	PVV N2 800	800	5297284	6288 09 0		306
OT3V GEKA80EL	/ AI / EL	5145196	6287 17 3		290	PVV N2 825	825	5297291	6288 09 2		306
OT3V GEKA80EL	/ AI / EL	5145196	6287 17 3		293	PVV N2 850	850	5147114	6288 06 4		306
OT3V GEKA80EL	/ AI / EL	5145196	6287 17 3		296	PVV N2 875	875	5147121	6288 06 6		306
OT3V GEKA80EL	/ AI / EL	5145196	6287 17 3		299						
OT3V GEKA80RW	Pure white/ AI	5145189	6287 17 0		266	PVV N2375	375	5297215	6288 07 6		306
OT3V GEKA80RW	Pure white/ AI	5145189	6287 17 0		269						
OT3V GEKA80RW	Pure white/ AI	5145189	6287 17 0		272						
OT3V GEKA80RW	Pure white/ AI	5145189	6287 17 0		275	RK-C5SF UTP1	Grey	5402466	6117 96 0		351
OT3V GEKA80RW	Pure white/ AI	5145189	6287 17 0		278	RK-C5SF UTP3	Grey	5402473	6117 96 2		351
OT3V GEKA80RW	Pure white/ AI	5145189	6287 17 0		281	RK-C5SF UTP5	Grey	5402480	6117 96 4		351
OT3V GEKA80RW	Pure white/ AI	5145189	6287 17 0		284						
OT3V GEKA80RW	Pure white/ AI	5145189	6287 17 0		287	RK-C6S FTP1	Grey	5402527	6117 96 6		351
OT3V GEKA80RW	Pure white/ AI	5145189	6287 17 0		290	RK-C6S FTP3	Grey	5402534	6117 96 8		351
OT3V GEKA80RW	Pure white/ AI	5145189	6287 17 0		293	RK-C6S FTP5	Grey	5402541	6117 97 0		351
OT3V GEKA80RW	Pure white/ AI	5145189	6287 17 0		296						
OT3V GEKA80RW	Pure white/ AI	5145189	6287 17 0		299						
				/pc.		RK-E1117GR	Stone grey 175/ PVC	6543137	6156 22 3		126
						RK-E1117LGR	Light grey 175/ PVC	6543076	6156 23 1		126
PAD-LQ6 AL1	Aluminium paint	5406549	6119 99 9		348						
PAD-LQ6 RW1	Pure white	5406532	6119 99 8		348	RK-K1117	120 166/ St / FS	6543199	6156 20 7		126
PAD-LQ6 SWGR1	Black-grey	5701507	6119 99 7		348						
						RKV3V		5149088	6288 70 0		221
						RKV3V		5149088	6288 70 0		226
PV N3 100H	100	5147176	6288 10 4		305	RKV3V		5149088	6288 70 0		231
						RKV3V		5149088	6288 70 0		237
PV N3 125H	125	5147183	6288 10 6		305	RKV3V		5149088	6288 70 0		242
						RKV3V		5149088	6288 70 0		248
PV N3 150H	150	5147213	6288 10 8		305	RKV3V		5149088	6288 70 0		253
						RKV3V		5149088	6288 70 0		259
PV N3 175H	175	5147220	6288 11 0		305						
						RS-BS1 AL1	Aluminium paint	5276005	6117 65 5		345
PV N3 200H	200	5147237	6288 11 2		305						
						RS-BS1 RW1	Pure white	5275992	6117 65 4		345
PV N3 225H	225	5147244	6288 11 4		305						
						RS-BS1 SWGR1	Black-grey	5701132	6117 65 3		345
PV N3 250H	250	5147275	6288 11 6		305						
						RT-BS1 AL1	Aluminium paint	5405955	6117 65 8		345
PV N3 275H	275	5147282	6288 11 8		305						
						RT-BS1 RW1	Pure white	5405948	6117 65 7		345
PV N3 300H	300	5147299	6288 12 0		305						
						RT-BS1 SWGR1	Black-grey	5701149	6117 65 6		345
PV N3 50H	50	5147152	6288 10 0		305						
PV N3 75H	75	5147169	6288 10 2		305						
PVV N2 100	100	5146865	6288 03 0		306	S990-AF1 AL	Aluminium paint/ pc	5405726	6107 00 8		353
PVV N2 125	125	5146872	6288 03 2		306						
PVV N2 150	150	5146889	6288 03 4		306	S990-AF1 RW	Pure white/ PC	5120957	6107 00 2		353
PVV N2 175	175	5146919	6288 03 6		306						
						S990-AF2 AL	Aluminium paint/ pc	5405740	6107 10 8		353
PVV N2 200	200	5146926	6288 03 8		306						
PVV N2 225	225	5146933	6288 04 0		306						
PVV N2 275	275	5146940	6288 04 2		306	S990-AF2 RW	Pure white/ PC	5121084	6107 10 2		353
PVV N2 300	300	5297185	6288 07 0		306						
PVV N2 325	325	5297192	6288 07 2		306	S990-AF3 AL	Aluminium paint/ pc	5405764	6107 20 8		354
PVV N2 350	350	5297208	6288 07 4		306						
						S990-AF3 RW	Pure white/ PC	5121244	6107 20 2		354
PVV N2 400	400	5297222	6288 07 8		306						
PVV N2 425	425	5297239	6288 08 0		306						
PVV N2 450	450	5297246	6288 08 2		306	S990-AFB1 AL	Aluminium paint/ pc	5405733	6107 05 8		354
PVV N2 475	475	5146971	6288 04 4		306						
						S990-AFB1 RW	Pure white/ PC	5121022	6107 05 2		354

06 LFS_Katalog_2010_Neuer_Stand / en / 22/02/2010 (LLEExport_00995)

Type	Dimensions/Colour/Div.	EAN-C.	Art. no.	Price	Page	Type	Dimensions/Colour/Div.	EAN-C.	Art. no.	Price	Page
S990-AFB2 AL	Aluminium paint/ pc	5405757	6107 15 8	/pc.	354	SKL-DS DBR	Sepia brown/ PVC	6157211	6199 42 5	/pc.	159
S990-AFB2 RW	Pure white/ PC	5121183	6107 15 2		354	SKL-DS DBR	Sepia brown/ PVC	6157211	6199 42 5		161
S990-AFB3 AL	Aluminium paint/ pc	5405771	6107 25 8		354	SKL-DS DBU	Beech/ PVC	6157570	6199 42 7		159
S990-AFB3 RW	Pure white/ PC	5121305	6107 25 2		354	SKL-DS DBU	Beech/ PVC	6157570	6199 42 7		161
S990-AR1 AL	Aluminium paint/ PC	5273288	6107 07 8		354	SKL-DS DCW	Cream/ PVC	6157099	6199 42 3		159
S990-AR1 RW	Pure white/ PC	5273240	6107 07 2		354	SKL-DS DCW	Cream/ PVC	6157099	6199 42 3		161
S990-AR2 AL	Aluminium paint/ PC	5273356	6107 17 8		354	SKL-DS DRW	Pure white/ PVC	6157037	6199 42 1		159
S990-AR2 RW	Pure white/ PC	5273349	6107 17 2		354	SKL-DS DRW	Pure white/ PVC	6157037	6199 42 1		161
S990-AR3 AL	Aluminium paint/ PC	5273424	6107 27 8		354	SKL-EL50DBR	Sepia brown/ PVC	6153435	6199 15 4		158
S990-AR3 RW	Pure white/ PC	5273417	6107 27 2		354	SKL-EL50DBU	Beech/ PVC	6153558	6199 15 6		158
S990-AR80 1 AL	Aluminium paint/ PC	5273479	6107 37 8		355	SKL-EL50DCW	Cream/ PVC	6153374	6199 15 2		158
S990-AR80 1 RW	Pure white/ PC	5273462	6107 37 2		355	SKL-EL50DRW	Pure white/ PVC	6153497	6199 15 0		158
SAISSF	/ St / VZ	5459279	6290 19 8		326	SKL-EL70DBR	Sepia brown/ PVC	6155958	6199 25 5		160
SAISSF	/ St / VZ	5459279	6290 19 8		328	SKL-EL70DBU	Beech/ PVC	6156016	6199 25 7		160
SAISSF	/ St / VZ	5459279	6290 19 8		330	SKL-EL70DCW	Cream/ PVC	6155897	6199 25 3		160
SE-B AL1	Aluminium paint	5405894	6117 61 6		345	SKL-EL70DRW	Pure white/ PVC	6155835	6199 25 1		160
SE-B RW1	Pure white	5405887	6117 61 5		345	SKL-ER50DBR	Sepia brown/ PVC	6153732	6199 16 7		158
SE-B SWGR1	Black-grey	5700999	6117 61 4		345	SKL-ER50DBU	Beech/ PVC	6153794	6199 16 9		158
SFISSFRW	Pure white/ St	5459231	6290 19 6		326	SKL-ER50DCW	Cream/ PVC	6153671	6199 16 5		158
SFISSFRW	Pure white/ St	5459231	6290 19 6		328	SKL-ER50DRW	Pure white/ PVC	6153619	6199 16 3		158
SFISSFRW	Pure white/ St	5459231	6290 19 6		330	SKL-ER70DBR	Sepia brown/ PVC	6156313	6199 26 6		160
SFISSFWAL	White aluminium/ St	5459248	6290 19 7		326	SKL-ER70DBU	Beech/ PVC	6156375	6199 26 8		160
SFISSFWAL	White aluminium/ St	5459248	6290 19 7		328	SKL-ER70DCW	Cream/ PVC	6156139	6199 26 4		160
SFISSFWAL	White aluminium/ St	5459248	6290 19 7		330	SKL-ER70DRW	Pure white/ PVC	6156078	6199 26 2		160
SG2545	/ ST	6628278	6028 41 1		85	SKL-I50DBR	Sepia brown/ PVC	6099993	6199 12 6		158
SK2545	/ ST	6628216	6028 40 3		85	SKL-I50DBU	Beech/ PVC	6100057	6199 12 8		158
SKL-45 DBR	Sepia brown/ PVC	6158898	6199 46 5		159	SKL-I50DCW	Cream/ PVC	6096268	6199 12 4		158
SKL-45 DBR	Sepia brown/ PVC	6158898	6199 46 5		161	SKL-I50DRW	Pure white/ PVC	6096503	6199 12 2		158
SKL-45 DBU	Beech/ PVC	6158959	6199 46 7		159	SKL-I70DBR	Sepia brown/ PVC	6154456	6199 22 7		160
SKL-45 DBU	Beech/ PVC	6158959	6199 46 7		161	SKL-I70DBU	Beech/ PVC	6154517	6199 22 9		160
SKL-45 DCW	Cream/ PVC	6158836	6199 46 3		159	SKL-I70DCW	Cream/ PVC	6154395	6199 22 5		160
SKL-45 DCW	Cream/ PVC	6158836	6199 46 3		161	SKL-I70DRW	Pure white/ PVC	6154333	6199 22 3		160
SKL-45 DRW	Pure white/ PVC	6158775	6199 46 1		159	SKL-R DBR	Sepia brown/ PVC	6156856	6199 40 6		159
SKL-45 DRW	Pure white/ PVC	6158775	6199 46 1		161	SKL-R DBR	Sepia brown/ PVC	6156856	6199 40 6		161
SKL-50DBR	Sepia brown 2000/ PVC	6096381	6199 10 7	/m	158	SKL-R DBU	Beech/ PVC	6156979	6199 40 8		159
SKL-50DBU	Beech 2000/ PVC	6096442	6199 10 9		158	SKL-R DBU	Beech/ PVC	6156979	6199 40 8		161
SKL-50DCW	Cream 2000/ PVC	6096206	6199 10 5		158	SKL-R DCW	Cream/ PVC	6156733	6199 40 4		159
SKL-50DRW	Pure white 2000/ PVC	6096329	6199 10 3		158	SKL-R DCW	Cream/ PVC	6156733	6199 40 4		161
SKL-70DBR	Sepia brown 2000/ PVC	6154210	6199 20 6		160	SKL-R DRW	Pure white/ PVC	6156795	6199 40 2		159
SKL-70DBU	Beech 2000/ PVC	6154272	6199 20 8		160	SKL-R DRW	Pure white/ PVC	6156795	6199 40 2		161
SKL-70DCW	Cream 2000/ PVC	6154159	6199 20 4		160	SKL-SA50DBR	Sepia brown/ PVC	6153978	6199 18 4		158
SKL-70DRW	Pure white 2000/ PVC	6154098	6199 20 2		160	SKL-SA50DBU	Beech/ PVC	6154036	6199 18 6		158
SKL-A50DBR	Sepia brown/ PVC	6153251	6199 13 7	/pc.	158	SKL-SA50DCW	Cream/ PVC	6153916	6199 18 2		158
SKL-A50DBU	Beech/ PVC	6153312	6199 13 9		158	SKL-SA50DRW	Pure white/ PVC	6153855	6199 18 0		158
SKL-A50DCW	Cream/ PVC	6153190	6199 13 5		158	SKL-SA70DBR	Sepia brown/ PVC	6156610	6199 28 5		160
SKL-A50DRW	Pure white/ PVC	6119615	6199 13 3		158	SKL-SA70DBU	Beech/ PVC	6156672	6199 28 7		160
SKL-A70DBR	Sepia brown/ PVC	6154692	6199 23 6		160	SKL-SA70DCW	Cream/ PVC	6156498	6199 28 3		160
SKL-A70DBU	Beech/ PVC	6155774	6199 23 8		160	SKL-SA70DRW	Pure white/ PVC	6156559	6199 28 1		160
SKL-A70DCW	Cream/ PVC	6154630	6199 23 4		160	SKL-Z DBR	Sepia brown/ PVC	6158652	6199 44 6		159
SKL-A70DRW	Pure white/ PVC	6154579	6199 23 2		160	SKL-Z DBR	Sepia brown/ PVC	6158652	6199 44 6		161
SKS-D0 AL1	Aluminium paint/ PC	6212774	6117 00 9		160	SKL-Z DBU	Beech/ PVC	6158713	6199 44 8		159
SKS-D0 AL2	Aluminium paint/ PC	6212835	6117 02 0		160	SKL-Z DBU	Beech/ PVC	6158713	6199 44 8		161
SKS-D0 AL3	Aluminium paint/ PC	6213078	6117 03 1		160	SKL-Z DCW	Cream/ PVC	6158294	6199 44 4		159
SKS-D0 MZGN1	Mint green/ PC	6458530	6117 00 5		160	SKL-Z DCW	Cream/ PVC	6158294	6199 44 4		161
						SKL-Z DRW	Pure white/ PVC	6157938	6199 44 2		159
						SKL-Z DRW	Pure white/ PVC	6157938	6199 44 2		161
						SKS-CH0 RW1	Pure white/ PC	5008866	6117 20 0		342

Type listing

Structure of the EAN number: Country code **40**

Manufacturer code **1219** (for articles beginning with **0: 1010**)

Individual EAN-C **5647589**

Type	Dimensions/Colour/Div.	EAN-C.	Art. no.	Price	Page	Type	Dimensions/Colour/Div.	EAN-C.	Art. no.	Price	Page
SKS-D0 MZGN2	Mint green / PC	6458837	6117 01 6	/pc.	338	SKS-F0 SWGR1	Black-grey / PC	5700944	6117 10 9	/pc.	339
SKS-D0 MZGN3	Mint green / PC	6458950	6117 02 7		339	SKS-F0 SWGR2	Black-grey / PC	5433552	6117 11 8		340
SKS-D0 ROR1	Orange / PC	6458356	6117 00 3		338	SKS-F0 SWGR3	Black-grey / PC	5433569	6117 13 0		340
SKS-D0 ROR2	Orange / PC	6458653	6117 01 4		338	SKS-F3 AL1	Aluminium paint/ PC	6213856	6117 14 8		340
SKS-D0 ROR3	Orange / PC	6645077	6117 02 5		339	SKS-F3 AL2	Aluminium paint/ PC	6213917	6117 15 9		340
SKS-D0 RW1	Pure white / PC	6458295	6117 00 1		338	SKS-F3 AL3	Aluminium paint/ PC	6213979	6117 17 0		340
SKS-D0 RW2	Pure white / PC	6518531	6117 01 2		338	SKS-F3 MZGN1	Mint green / PC	6287291	6117 14 4		340
SKS-D0 RW3	Pure white / PC	6458899	6117 02 3		339	SKS-F3 MZGN2	Mint green / PC	6637218	6117 15 5		340
SKS-D0 SRO1	Signal red / PC	6458592	6117 00 7		338	SKS-F3 MZGN3	Mint green / PC	6461356	6117 16 6		340
SKS-D0 SRO2	Signal red / PC	6471072	6117 01 8		338	SKS-F3 ROR1	Orange / PC	6189854	6117 14 2		340
SKS-D0 SRO3	Signal red / PC	6597376	6117 02 9		339	SKS-F3 ROR2	Orange / PC	6538690	6117 15 3		340
SKS-D0 SWGR1	Black-grey / PC	5700883	6117 00 8		338	SKS-F3 ROR3	Orange / PC	6461233	6117 16 4		340
SKS-D0 SWGR2	Black-grey / PC	5648956	6117 01 9		338	SKS-F3 RW1	Pure white / PC	6189793	6117 14 0		340
SKS-D0 SWGR3	Black-grey / PC	5700890	6117 03 0		339	SKS-F3 RW2	Pure white / PC	6460632	6117 15 1		340
SKS-D3 AL1	Aluminium paint/ PC	6213139	6117 04 9		339	SKS-F3 RW3	Pure white / PC	6461110	6117 16 2		340
SKS-D3 AL2	Aluminium paint/ PC	6213191	6117 06 0		339	SKS-F3 SRO1	Signal red / PC	6287536	6117 14 6		340
SKS-D3 AL3	Aluminium paint/ PC	6213436	6117 07 1		339	SKS-F3 SRO2	Signal red / PC	6461059	6117 15 7		340
SKS-D3 MZGN1	Mint green / PC	6459131	6117 04 5		339	SKS-F3 SRO3	Signal red / PC	6461530	6117 16 8		340
SKS-D3 MZGN2	Mint green / PC	6459674	6117 05 6		339	SKS-F3 SWGR1	Black-grey / PC	5700968	6117 14 7		340
SKS-D3 MZGN3	Mint green / PC	6459971	6117 06 7		339	SKS-F3 SWGR2	Black-grey / PC	5700975	6117 15 8		340
SKS-D3 ROR1	Orange / PC	6459070	6117 04 3		339	SKS-F3 SWGR3	Black-grey / PC	5700982	6117 16 9		340
SKS-D3 ROR2	Orange / PC	6459612	6117 05 4		339	SKS-FC0 AL1	Aluminium paint/ PC	5364191	6106 67 9		341
SKS-D3 ROR3	Orange / PC	6459858	6117 06 5		339	SKS-FC0 AL2	Aluminium paint/ PC	5364269	6106 68 9		341
SKS-D3 RW1	Pure white / PC	6459018	6117 04 1		339	SKS-FC0 AL3	Aluminium paint/ PC	5364375	6106 69 9		341
SKS-D3 RW2	Pure white / PC	6459551	6117 05 2		339	SKS-FC0 MZGN1	Mint green / PC	5364177	6106 67 5		341
SKS-D3 RW3	Pure white / PC	6459797	6117 06 3		339	SKS-FC0 MZGN2	Mint green / PC	5364245	6106 68 5		341
SKS-D3 SRO1	Signal red / PC	6459377	6117 04 7		339	SKS-FC0 MZGN3	Mint green / PC	5364320	6106 69 5		341
SKS-D3 SRO2	Signal red / PC	6459735	6117 05 8		339	SKS-FC0 ROR1	Orange / PC	5364146	6106 67 3		341
SKS-D3 SRO3	Signal red / PC	6460038	6117 06 9		339	SKS-FC0 ROR2	Orange / PC	5364238	6106 68 3		341
SKS-D3 SWGR1	Black-grey / PC	5700906	6117 04 8		339	SKS-FC0 ROR3	Orange / PC	5364313	6106 69 3		341
SKS-D3 SWGR2	Black-grey / PC	5700913	6117 05 9		339	SKS-FC0 RW1	Pure white / PC	5364139	6106 67 1		341
SKS-D3 SWGR3	Black-grey / PC	5700920	6117 07 0		339	SKS-FC0 RW2	Pure white / PC	5364207	6106 68 1		341
SKS-DK0 RW1	Pure white / PC	5462231	6117 20 2		342	SKS-FC0 RW3	Pure white / PC	5364306	6106 69 1		341
SKS-DKE0 RW1	Pure white / PC	5616016	6117 20 3		342	SKS-FC0 SRO1	Signal red / PC	5364184	6106 67 7		341
SKS-DS3 AL2	Aluminium paint/ PC	5437987	6117 08 2		343	SKS-FC0 SRO2	Signal red / PC	5364252	6106 68 7		341
SKS-DS3 AL3	Aluminium paint/ PC	5670919	6119 86 0		343	SKS-FC0 SRO3	Signal red / PC	5364368	6106 69 7		341
SKS-DS3 MZGN2	Mint green / PC	5437949	6117 07 8		343	SKS-FC3 AL1	Aluminium paint/ PC	5364443	6106 70 9		341
SKS-DS3 MZGN3	Mint green / PC	5670889	6119 85 4		343	SKS-FC3 AL2	Aluminium paint/ PC	5364535	6106 71 9		341
SKS-DS3 ROR2	Orange / PC	5437932	6117 07 6		343	SKS-FC3 AL3	Aluminium paint/ PC	5364603	6106 72 9		342
SKS-DS3 ROR3	Orange / PC	5670872	6119 85 2		343	SKS-FC3 MZGN1	Mint green / PC	5364429	6106 70 5		341
SKS-DS3 RW2	Pure white / PC	5437925	6117 07 4		343	SKS-FC3 MZGN2	Mint green / PC	5364498	6106 71 5		341
SKS-DS3 RW3	Pure white / PC	5670865	6119 85 0		343	SKS-FC3 MZGN3	Mint green / PC	5364566	6106 72 5		342
SKS-DS3 SRO2	Signal red / PC	5437970	6117 08 0		343	SKS-FC3 ROR1	Orange / PC	5364412	6106 70 3		341
SKS-DS3 SRO3	Signal red / PC	5670896	6119 85 6		343	SKS-FC3 ROR2	Orange / PC	5364481	6106 71 3		341
SKS-DS3 SWGR2	Black-grey / PC	5700937	6117 08 1		343	SKS-FC3 ROR3	Orange / PC	5364559	6106 72 3		342
SKS-DS3 SWGR3	Black-grey / PC	5670902	6119 85 8		343	SKS-FC3 RW1	Pure white / PC	5364382	6106 70 1		341
SKS-F0 AL1	Aluminium paint/ PC	6213498	6117 11 0		339	SKS-FC3 RW2	Pure white / PC	5364474	6106 71 1		341
SKS-F0 AL2	Aluminium paint/ PC	6213559	6117 11 9		340	SKS-FC3 RW3	Pure white / PC	5364542	6106 72 1		342
SKS-F0 AL3	Aluminium paint/ PC	6213795	6117 13 1		340	SKS-FC3 SRO1	Signal red / PC	5364436	6106 70 7		341
SKS-F0 MZGN1	Mint green / PC	6460212	6117 10 6		339	SKS-FC3 SRO2	Signal red / PC	5364504	6106 71 7		341
SKS-F0 MZGN2	Mint green / PC	6188956	6117 11 5		340	SKS-FC3 SRO3	Signal red / PC	5364597	6106 72 7		342
SKS-F0 MZGN3	Mint green / PC	6189373	6117 12 7		340	SKS-FS3 AL2	Aluminium paint/ PC	5670995	6119 87 8		343
SKS-F0 ROR1	Orange / PC	6460151	6117 10 4		339	SKS-FS3 AL3	Aluminium paint/ PC	5671084	6119 89 0		343
SKS-F0 ROR2	Orange / PC	6460458	6117 11 3		340	SKS-FS3 MZGN2	Mint green / PC	5670964	6119 87 2		343
SKS-F0 ROR3	Orange / PC	6189311	6117 12 5		340	SKS-FS3 MZGN3	Mint green / PC	5671022	6119 88 4		343
SKS-F0 RW1	Pure white / PC	6460090	6117 10 2		339	SKS-FS3 ROR2	Orange / PC	5670957	6119 87 0		343
SKS-F0 RW2	Pure white / PC	6460335	6117 11 1		340	SKS-FS3 ROR3	Orange / PC	5671015	6119 88 2		343
SKS-F0 RW3	Pure white / PC	6189076	6117 12 3		340	SKS-FS3 RW2	Pure white / PC	5670926	6119 86 8		343
SKS-F0 SRO1	Signal red / PC	6460274	6117 10 8		339	SKS-FS3 RW3	Pure white / PC	5671008	6119 88 0		343
SKS-F0 SRO2	Signal red / PC	6189014	6117 11 7		340	SKS-FS3 SRO2	Signal red / PC	5670971	6119 87 4		343
SKS-F0 SRO3	Signal red / PC	6189618	6117 12 9		340	SKS-FS3 SRO3	Signal red / PC	5671039	6119 88 6		343
						SKS-FS3 SWGR2	Black-grey / PC	5670988	6119 87 6		343
						SKS-FS3 SWGR3	Black-grey / PC	5671046	6119 88 8		343
						SP3	/ St / FS	5680680	6279 80 0		305
						STA-SKS S1 SW	Black	5438090	6117 19 2		343

06 LFS_Katalog_2010_Neuer_Stand / en / 22/02/2010 (LLEExport_00995)

Type	Dimensions/Colour/Div.	EAN-C.	Art. no.	Price	Page	Type	Dimensions/Colour/Div.	EAN-C.	Art. no.	Price	Page
STA-SKS S1 W	White	5483571	6117 19 3	/pc.	343	WDK HA100130CW	Cream 170/ PVC	6107650	6161 15 4	/pc.	118
STA-SKS SU1 SW	Black	5670933	6117 19 6		344	WDK HA100130GR	Stone grey 170/ PVC	6027798	6024 58 0		118
STA-SKS SU1 W	White	5670940	6117 19 7		344	WDK HA100130LGR	Light grey 170/ PVC	6676996	6182 74 7		118
						WDK HA100130RW	Pure white 170/ PVC	5042600	6192 42 4		118
						WDK HA10020CW	Cream 30/ PVC	6099979	6153 29 1		86
TA-B AL0.5	Aluminium paint	5276050	6117 67 1		344	WDK HA10020RW	Pure white 30/ PVC	6492015	6154 41 7		86
						WDK HA100230CW	Cream 170/ PVC	6501854	6161 17 0		120
TA-B AL1	Aluminium paint	5623816	6117 67 4		344	WDK HA100230GR	Stone grey 170/ PVC	6501915	6024 68 8		120
						WDK HA100230LGR	Light grey 170/ PVC	6501793	6182 76 3		120
TA-B RW0.5	Pure white	5276043	6117 67 0		344	WDK HA100230RW	Pure white 170/ PVC	5042693	6192 42 8		120
						WDK HA10030CW	Cream 30/ PVC	6804498	6153 30 5		88
TA-B RW1	Pure white	5623809	6117 67 3		344	WDK HA10030RW	Pure white 30/ PVC	6491537	6154 42 5		88
						WDK HA15030CW	Cream 38,5/ PVC	6579198	6160 61 1		91
TA-B SWGR0.5	Black-grey	5701156	6117 66 8		344	WDK HA15030GR	Stone grey 38,5/ PVC	6579136	6158 35 8		91
TA-B SWGR1	Black-grey	5701323	6117 66 9		344	WDK HA15030RW	Pure white 38,5/ PVC	6795253	6192 14 9		91
						WDK HA15040CW	Cream 42/ PVC	6579372	6160 63 8		93
						WDK HA15040GR	Stone grey 42/ PVC	6579310	6158 36 6		93
TAE-6F AL1	Aluminium paint	6215959	6117 43 0		347	WDK HA15040RW	Pure white 42/ PVC	6494712	6192 15 7		93
						WDK HA20020CW	Cream 38,5/ PVC	6579013	6160 60 3		95
TAE-6F RW1	Pure white	6215713	6117 42 8		347	WDK HA20020GR	Stone grey 38,5/ PVC	6578955	6158 33 1		95
						WDK HA20020LGR	Light grey 38,5/ PVC	6675197	6182 40 2		95
						WDK HA20020RW	Pure white 38,5/ PVC	6795314	6192 16 5		95
TW BR-A	Light grey/ PVC	6192670	6023 08 5		189	WDK HA20050CW	Cream 45/ PVC	6507856	6153 37 2		97
TW BR-A	Light grey/ PVC	6192670	6023 08 5		192	WDK HA20050RW	Pure white 45/ PVC	6493210	6154 46 8		97
TW BR-A	Light grey/ PVC	6192670	6023 08 5		195						
TW BR-A	Light grey/ PVC	6192670	6023 08 5		202						
TW BR-A	Light grey/ PVC	6192670	6023 08 5		205	WDK HA25025CW	Cream 50/ PVC	6579556	6160 64 6		99
						WDK HA25025GR	Stone grey 50/ PVC	6579495	6158 37 4		99
TW BR-F	Light grey/ PVC	6192731	6023 08 9		188	WDK HA25025LGR	Light grey 50/ PVC	6675258	6182 44 5		99
TW BR-F	Light grey/ PVC	6192731	6023 08 9		192	WDK HA25025RW	Pure white 50/ PVC	6504855	6192 17 3		99
TW BR-F	Light grey/ PVC	6192731	6023 08 9		194						
TW BR-F	Light grey/ PVC	6192731	6023 08 9		201	WDK HA25040CW	Cream 52/ PVC	6579730	6160 65 4		100
TW BR-F	Light grey/ PVC	6192731	6023 08 9		204	WDK HA25040GR	Stone grey 52/ PVC	6579679	6158 38 2		100
						WDK HA25040RW	Pure white 52/ PVC	6795376	6192 18 1		100
						WDK HA30030CW	Cream 57/ PVC	6580095	6160 67 0		102
TW BR-I	Light grey/ PVC	6192618	6023 08 1		189	WDK HA30030GR	Stone grey 57/ PVC	6580033	6158 40 4		102
TW BR-I	Light grey/ PVC	6192618	6023 08 1		192	WDK HA30030LGR	Light grey 57/ PVC	6675319	6182 48 8		102
TW BR-I	Light grey/ PVC	6192618	6023 08 1		195	WDK HA30030RW	Pure white 57/ PVC	6795437	6192 21 1		102
TW BR-I	Light grey/ PVC	6192618	6023 08 1		201	WDK HA30045CW	Cream 57/ PVC	6641598	6160 68 9		103
						WDK HA30045GR	Stone grey 57/ PVC	6641536	6158 42 0		103
						WDK HA30045LGR	Light grey 57/ PVC	6675371	6182 49 6		103
						WDK HA30045RW	Pure white 57/ PVC	6497171	6192 23 8		103
TW ISS120	2000/ ST / FS	5149521	6288 83 0	/m	318						
						WDK HA40040CW	Cream 66/ PVC	6580279	6160 69 7		104
						WDK HA40040GR	Stone grey 66/ PVC	6580217	6158 41 2		104
TWWRW	Pure white/ Al	5162162	6290 24 0	/pc.	322	WDK HA40040LGR	Light grey 66/ PVC	6675432	6182 52 6		104
TWWRW	Pure white/ Al	5162162	6290 24 0		324	WDK HA40040RW	Pure white 66/ PVC	6795499	6192 24 6		104
						WDK HA40060CW	Cream 100/ PVC	6106813	6160 70 0		105
						WDK HA40060GR	Stone grey 100/ PVC	6019212	6021 69 7		105
				/100 pc.		WDK HA40060LGR	Light grey 100/ PVC	6675494	6182 53 4		105
ULS	Grey 3/ PVC	6015061	6178 54 8		185	WDK HA40060RW	Pure white 100/ PVC	6795550	6192 25 4		105
						WDK HA40090CW	Cream 100/ PVC	6106875	6160 71 9		106
						WDK HA40090GR	Stone grey 100/ PVC	6017171	6021 09 3		106
						WDK HA40090LGR	Light grey 100/ PVC	6675555	6182 54 2		106
ÜSM-A		5080886	5092 45 1	/pc.	346	WDK HA40090RW	Pure white 100/ PVC	6795611	6192 26 2		106
						WDK HA40110CW	Cream 100/ PVC	6106936	6160 72 7		107
						WDK HA40110GR	Stone grey 100/ PVC	6019274	6021 70 0		107
ÜSS 45-A-ALU	Aluminium paint	5006220	6117 46 7		346	WDK HA40110LGR	Light grey 100/ PVC	6675616	6182 55 0		107
ÜSS 45-A-RW	Pure white	6117611	6117 46 5		346	WDK HA40110RW	Pure white 100/ PVC	6220878	6192 27 0		107
						WDK HA60060CW	Cream 100/ PVC	6107179	6160 90 5		108
						WDK HA60060GR	Stone grey 100/ PVC	6020539	6022 07 3		108
						WDK HA60060LGR	Light grey 100/ PVC	6676392	6182 59 3		108
						WDK HA60060RW	Pure white 100/ PVC	6360970	6192 31 9		108
VB-SKS S	Black	5438113	6117 19 8		344	WDK HA60090CW	Cream 100/ PVC	6107230	6160 91 3		109
						WDK HA60090GR	Stone grey 100/ PVC	6020713	6022 11 1		109
						WDK HA60090LGR	Light grey 100/ PVC	6676453	6182 60 7		109
WAG140100RRW	Pure white/ St	5648963	6290 29 0		327	WDK HA60090RW	Pure white 100/ PVC	6801558	6192 32 7		109
WAG140100RRW	Pure white/ St	5648963	6290 29 0		329	WDK HA60110CW	Cream 100/ PVC	6107292	6160 92 1		111
						WDK HA60110GR	Stone grey 100/ PVC	6020836	6022 14 6		111
WAG14022ARW	Pure white/ Al	5162179	6290 25 0		325	WDK HA60110LGR	Light grey 100/ PVC	6676514	6182 61 5		111
						WDK HA60110RW	Pure white 100/ PVC	6354559	6192 33 5		111
WAG701400	Pure white/ St	5418566	6290 26 0		320	WDK HA60130CW	Cream 100/ PVC	6107353	6160 94 8		112
WAG70140TRW	Pure white/ ST	5162063	6290 20 0		320	WDK HA60130GR	Stone grey 100/ PVC	6020959	6022 16 2		112
WAG70140TRW	Pure white/ ST	5162063	6290 20 0		322	WDK HA60130LGR	Light grey 100/ PVC	6676576	6182 62 3		112
						WDK HA60130RW	Pure white 100/ PVC	6353057	6192 34 3		112
WAG90110ARW	Pure white/ Al	5162117	6290 22 0		323	WDK HA60150CW	Cream 100/ PVC	6638352	6160 97 2		113
						WDK HA60150GR	Stone grey 100/ PVC	6638291	6024 52 1		113

Type listing

Structure of the EAN number: Country code **40**

Manufacturer code **1219** (for articles beginning with **0: 1010**)

Individual EAN-C **5647589**

Type	Dimensions/Colour/Div.	EAN-C.	Art. no.	Price	Page	Type	Dimensions/Colour/Div.	EAN-C.	Art. no.	Price	Page
WDK HA60150LGR	Light grey 100/ PVC	6676637	6182 63 1	/pc.	113	WDK HE40040RW	Pure white 40/ PVC	6712939	6193 21 8	/pc.	104
WDK HA60150RW	Pure white 100/ PVC	6492312	6192 35 1		113	WDK HE40060CW	Cream 60/ PVC	6109517	6162 60 6		105
WDK HA60170CW	Cream 100/ PVC	6107414	6160 95 6		114	WDK HE40060GR	Stone grey 60/ PVC	6018857	6021 49 2		105
WDK HA60170GR	Stone grey 100/ PVC	6021079	6022 18 9		114	WDK HE40060LGR	Light grey 60/ PVC	6674350	6183 73 5		105
WDK HA60170LGR	Light grey 100/ PVC	6676699	6182 65 8		114	WDK HE40060RW	Pure white 60/ PVC	6797479	6193 22 6		105
WDK HA60170RW	Pure white 100/ PVC	6795673	6192 37 8		114	WDK HE40090CW	Cream 90/ PVC	6109579	6162 61 4		106
WDK HA60210CW	Cream 100/ PVC	6107476	6160 96 4		115	WDK HE40090GR	Stone grey 90/ PVC	6018918	6021 50 6		106
WDK HA60210GR	Stone grey 100/ PVC	6021130	6022 19 7		115	WDK HE40090LGR	Light grey 90/ PVC	6674411	6183 74 3		106
WDK HA60210LGR	Light grey 100/ PVC	6676750	6182 66 6		115	WDK HE40090RW	Pure white 90/ PVC	6797530	6193 23 4		106
WDK HA60210RW	Pure white 100/ PVC	6795673	6192 38 6		115	WDK HE40110CW	Cream 110/ PVC	6109630	6162 62 2		107
WDK HA60230CW	Cream 100/ PVC	6639731	6160 98 0		110	WDK HE40110GR	Stone grey 110/ PVC	6018970	6021 51 4		107
WDK HA60230GR	Stone grey 100/ PVC	6639670	6024 54 8		110	WDK HE40110LGR	Light grey 110/ PVC	6674473	6183 75 1		107
WDK HA60230LGR	Light grey 100/ PVC	6676811	6182 67 4		110	WDK HE40110RW	Pure white 110/ PVC	6974788	6193 24 2		107
WDK HA60230RW	Pure white 100/ PVC	6492374	6192 39 4		110	WDK HE60060CW	Cream 60/ PVC	6109876	6162 80 0		108
WDK HA80170CW	Cream 150/ PVC	6107537	6161 10 3		119	WDK HE60060GR	Stone grey 60/ PVC	6022694	6022 49 9		108
WDK HA80170GR	Stone grey 150/ PVC	6027675	6024 56 4		119	WDK HE60060LGR	Light grey 60/ PVC	6678372	6183 80 8		108
WDK HA80170LGR	Light grey 150/ PVC	6676873	6182 71 2		119	WDK HE60060RW	Pure white 60/ PVC	6712991	6193 28 5		108
WDK HA80170RW	Pure white 150/ PVC	5042464	6192 41 6		119	WDK HE60090CW	Cream 90/ PVC	6109937	6162 81 9		109
WDK HA80210CW	Cream 150/ PVC	6107599	6161 11 1		117	WDK HE60090GR	Stone grey 90/ PVC	6022755	6022 50 2		109
WDK HA80210GR	Stone grey 150/ PVC	6027736	6024 57 2		117	WDK HE60090LGR	Light grey 90/ PVC	6678433	6183 81 6		109
WDK HA80210LGR	Light grey 150/ PVC	6676934	6182 72 0		117	WDK HE60090RW	Pure white 90/ PVC	6492794	6193 29 3		109
WDK HA80210RW	Pure white 150/ PVC	5042532	6192 42 0		117	WDK HE60110CW	Cream 110/ PVC	6109999	6162 82 7		111
WDK HE100130CW	Cream 150/ PVC	6110353	6163 04 1		118	WDK HE60110GR	Stone grey 110/ PVC	6022991	6022 58 8		111
WDK HE100130GR	Stone grey 150/ PVC	6028337	6024 88 2		118	WDK HE60110LGR	Light grey 110/ PVC	6678495	6183 82 4		111
WDK HE100130LGR	Light grey 150/ PVC	6678976	6183 95 6		118	WDK HE60110RW	Pure white 110/ PVC	6713059	6193 30 7		111
WDK HE100130RW	Pure white 150/ PVC	5042655	6193 39 5		118	WDK HE60130CW	Cream 130/ PVC	6110056	6162 83 5		112
WDK HE10020CW	Cream 22/ PVC	6100392	6153 59 3		87	WDK HE60130GR	Stone grey 130/ PVC	6022816	6022 52 9		112
WDK HE10020RW	Pure white 22/ PVC	6491834	6154 51 4		87	WDK HE60130LGR	Light grey 130/ PVC	6678566	6183 83 2		112
WDK HE100230CRW	Cream 230/ PVC	6651436	6163 07 6		120	WDK HE60130RW	Pure white 130/ PVC	6713110	6193 31 5		112
WDK HE100230GR	Stone grey 230/ PVC	6651375	6024 90 4		120	WDK HE60150CW	Cream 150/ PVC	6637997	6162 87 8		113
WDK HE100230LGR	Light grey 230/ PVC	6679034	6183 98 0		120	WDK HE60150GR	Stone grey 150/ PVC	6637935	6024 82 3		113
WDK HE100230RW	Pure white 230/ PVC	5042723	6193 39 9		120	WDK HE60150LGR	Light grey 150/ PVC	6678617	6183 84 0		113
WDK HE10030CW	Cream 32/ PVC	6100453	6153 60 7		89	WDK HE60150RW	Pure white 150/ PVC	6492855	6193 32 3		113
WDK HE10030GR	Cream 17/ PVC	6583454	6162 50 9		95	WDK HE60170CW	Cream 170/ PVC	6110117	6162 84 3		114
WDK HE10030LGR	Stone grey 17/ PVC	6434473	6158 70 6		95	WDK HE60170GR	Stone grey 170/ PVC	6022878	6022 54 5		114
WDK HE10030RW	Pure white 32/ PVC	6491353	6154 52 2		89	WDK HE60170LGR	Light grey 170/ PVC	6678679	6183 85 9		114
WDK HE15015CW	Cream 15/ PVC	6642670	6162 49 5		90	WDK HE60170RW	Pure white 170/ PVC	6713172	6193 33 1		114
WDK HE15015GR	Stone grey 15/ PVC	6642618	6158 69 2		90	WDK HE60210CW	Cream 210/ PVC	6110179	6162 85 1		116
WDK HE15015LGR	Light grey 15/ PVC	6673933	6183 60 3		90	WDK HE60210GR	Stone grey 210/ PVC	6022939	6022 56 1		116
WDK HE15015RW	Pure white 15/ PVC	6797172	6193 09 9		90	WDK HE60210LGR	Light grey 210/ PVC	6678730	6183 86 7		116
WDK HE15030CW	Cream 30/ PVC	6583577	6162 51 7		90	WDK HE60210RW	Pure white 210/ PVC	6797592	6193 35 8		116
WDK HE15030GR	Stone grey 30/ PVC	6434534	6158 71 4		92	WDK HE60230CW	Cream 230/ PVC	6639373	6162 88 6		110
WDK HE15030RW	Pure white 30/ PVC	6797233	6193 10 2		92	WDK HE60230GR	Stone grey 230/ PVC	6639311	6024 83 1		110
WDK HE15040CW	Cream 40/ PVC	6583690	6162 52 5		92	WDK HE60230LGR	Light grey 230/ PVC	6678792	6183 87 5		110
WDK HE15040GR	Stone grey 40/ PVC	6434596	6158 72 2		94	WDK HE60230RW	Pure white 230/ PVC	6492916	6193 36 6		110
WDK HE15040RW	Pure white 40/ PVC	6975624	6193 11 0		94	WDK HE80170CW	Cream 150/ PVC	6110230	6163 00 9		119
WDK HE20020LGR	Light grey 17/ PVC	6673995	6183 61 1		94	WDK HE80170GR	Stone grey 150/ PVC	6028214	6024 85 8		119
WDK HE20020RW	Pure white 17/ PVC	6797295	6193 12 9		95	WDK HE80170LGR	Light grey 150/ PVC	6678853	6183 91 3		119
WDK HE20035CW	Cream 35/ PVC	6643219	6162 48 7		95	WDK HE80170RW	Pure white 150/ PVC	5042518	6193 38 7		119
WDK HE20035GR	Stone grey 35/ PVC	6643158	6158 78 1		95	WDK HE80210CW	Cream 150/ PVC	6110292	6163 01 7		117
WDK HE20035LGR	Light grey 35/ PVC	6674053	6183 65 4		96	WDK HE80210GR	Stone grey 150/ PVC	6028276	6024 87 4		117
WDK HE20035RW	Pure white 35/ PVC	6976768	6193 13 7		96	WDK HE80210LGR	Light grey 150/ PVC	6678914	6183 92 1		117
WDK HE20050CW	Cream 50/ PVC	6507672	6153 67 4		96	WDK HE80210RW	Pure white 150/ PVC	5042587	6193 39 1		117
WDK HE20050RW	Pure white 50/ PVC	6493395	6154 55 7		98	WDK HF100130CW	Cream 166/ PVC	6108558	6161 75 8		118
WDK HE25025CW	Cream 25/ PVC	6583812	6162 53 3		98	WDK HF100130GR	Stone grey 166/ PVC	6027972	6024 63 7		118
WDK HE25025GR	Stone grey 25/ PVC	6434657	6158 73 0		98	WDK HF100130LGR	Light grey 166/ PVC	6678310	6183 55 7		118
WDK HE25025LGR	Light grey 25/ PVC	6674114	6183 66 2		99	WDK HF100130RW	Pure white 166/ PVC	5042648	6193 02 9		118
WDK HE25025RW	Pure white 25/ PVC	6504794	6193 14 5		99	WDK HF10020CW	Cream 40/ PVC	6099139	6193 02 9		86
WDK HE25040CW	Cream 40/ PVC	6583935	6162 54 1		99	WDK HF10020RW	Pure white 40/ PVC	6491896	6154 21 2		86
WDK HE25040GR	Stone grey 40/ PVC	6434718	6158 74 9		99	WDK HF100230CW	Cream 266/ PVC	6501250	6161 77 4		120
WDK HE25040RW	Pure white 40/ PVC	6797356	6193 15 3		101	WDK HF100230GR	Stone grey 266/ PVC	6501311	6024 65 3		120
WDK HE30030CW	Cream 30/ PVC	6584239	6162 57 6		101	WDK HF100230LGR	Light grey 266/ PVC	6222131	6183 57 3		120
WDK HE30030GR	Stone grey 30/ PVC	6584178	6158 76 5		101	WDK HF100230RW	Pure white 266/ PVC	5042716	6193 03 3		120
WDK HE30030LGR	Light grey 30/ PVC	6674176	6183 69 7		101	WDK HF10030CW	Cream 50/ PVC	6099191	6152 61 9		88
WDK HE30030RW	Pure white 30/ PVC	6797417	6193 18 8		102	WDK HF10030RW	Pure white 50/ PVC	6491414	6154 22 0		88
WDK HE30045CW	Cream 45/ PVC	6641239	6162 58 4		102	WDK HF15030CW	Cream 53/ PVC	6582075	6161 21 9		91
WDK HE30045GR	Stone grey 45/ PVC	6434831	6158 80 3		103	WDK HF15030GR	Stone grey 53/ PVC	6582013	6158 59 5		91
WDK HE30045LGR	Light grey 45/ PVC	6674237	6183 70 0		103	WDK HF15030RW	Pure white 53/ PVC	6796694	6192 75 0		91
WDK HE30045RW	Pure white 45/ PVC	6497355	6193 19 6		103	WDK HF15040CW	Cream 63/ PVC	6582259	6161 22 7		93
WDK HE40040CW	Cream 40/ PVC	6583331	6162 59 2		104	WDK HF15040GR	Stone grey 63/ PVC	6582198	6158 60 9		93
WDK HE40040GR	Stone grey 40/ PVC	6583270	6158 77 3		104	WDK HF15040RW	Pure white 63/ PVC	6494835	6192 76 9		93
WDK HE40040LGR	Light grey 40/ PVC	6674299	6183 72 7		104	WDK HF20020CW	Cream 38/ PVC	6581894	6161 20 0		95
						WDK HF20020GR	Stone grey 38/ PVC	6581832	6158 58 7		95
						WDK HF20020LGR	Light grey 38/ PVC	6673391	6183 21 2		95

06_LFS_Katalog_2010_Neuer_Stand / en / 22/02/2010 (LLEExport_00995)

Type	Dimensions/Colour/Div.	EAN-C.	Art. no.	Price	Page	Type	Dimensions/Colour/Div.	EAN-C.	Art. no.	Price	Page
WDK HF20020RW	Pure white 38/ PVC	6796755	6192 77 7	/pc.	95	WDK HI100130CW	Cream 170/ PVC	6106752	6160 52 2	/pc.	118
WDK HF20050CW	Cream 73/ PVC	6507733	6152 68 6		97	WDK HI100130GR	Stone grey 170/ PVC	6027613	6024 48 3		118
WDK HF20050RW	Pure white 73/ PVC	6493333	6154 25 5		97	WDK HI100130LGR	Light grey 170/ PVC	6676330	6182 34 8		118
WDK HF25025CW	Cream 48/ PVC	6582433	6161 23 5		99	WDK HI100130RW	Pure white 170/ PVC	5042594	6192 11 4		118
WDK HF25025GR	Stone grey 48/ PVC	6582372	6158 61 7		99	WDK HI10020CW	Cream 30/ PVC	6099559	6153 00 3		86
WDK HF25025LGR	Light grey 48/ PVC	6673452	6183 25 5		99	WDK HI10020RW	Pure white 30/ PVC	6492077	6154 32 8		86
WDK HF25025RW	Pure white 48/ PVC	6504916	6192 78 5		99	WDK HI100230CW	Cream 170/ PVC	6502035	6160 54 9		120
WDK HF25040CW	Cream 63/ PVC	6582617	6161 24 3		100	WDK HI100230GR	Stone grey 170/ PVC	6502097	6024 50 5		120
WDK HF25040GR	Stone grey 63/ PVC	6582556	6158 62 5		100	WDK HI100230LGR	Light grey 170/ PVC	6501977	6182 36 4		120
WDK HF25040RW	Pure white 63/ PVC	6796816	6192 79 3		100	WDK HI100230RW	Pure white 170/ PVC	5042662	6192 11 8		120
WDK HF30030CW	Cream 53/ PVC	6582976	6161 27 8		102	WDK HI10030CW	Cream 30/ PVC	6099610	6153 01 1		88
WDK HF30030GR	Stone grey 53/ PVC	6582914	6158 64 1		102	WDK HI10030RW	Pure white 30/ PVC	6491599	6154 33 6		88
WDK HF30030LGR	Light grey 53/ PVC	6673513	6183 29 8		102	WDK HI15030CW	Cream 38,5/ PVC	6577811	6160 02 6		91
WDK HF30030RW	Pure white 53/ PVC	6796878	6192 81 5		102	WDK HI15030GR	Stone grey 38,5/ PVC	6577750	6158 23 4		91
WDK HF30045CW	Cream 68/ PVC	6641772	6161 28 6		103	WDK HI15030RW	Pure white 38,5/ PVC	6794652	6191 84 3		91
WDK HF30045GR	Stone grey 68/ PVC	6641710	6158 67 6		103	WDK HI15040CW	Cream 42/ PVC	6577996	6160 03 4		93
WDK HF30045LGR	Light grey 68/ PVC	6673575	6183 30 1		103	WDK HI15040GR	Stone grey 42/ PVC	6577934	6158 24 2		93
WDK HF30045RW	Pure white 68/ PVC	6497294	6192 82 3		103	WDK HI15040RW	Pure white 42/ PVC	6494651	6191 85 1		93
WDK HF40040CW	Cream 63/ PVC	6583157	6161 29 4		104	WDK HI20020CW	Cream 38,5/ PVC	6577637	6160 01 8		95
WDK HF40040GR	Stone grey 63/ PVC	6583096	6158 66 8		104	WDK HI20020GR	Stone grey 38,5/ PVC	6577576	6158 22 6		95
WDK HF40040LGR	Light grey 63/ PVC	6673636	6183 33 6		104	WDK HI20020LGR	Light grey 38,5/ PVC	6674657	6182 01 1		95
WDK HF40040RW	Pure white 63/ PVC	6796939	6192 83 1		104	WDK HI20020RW	Pure white 38,5/ PVC	6794713	6191 87 8		95
WDK HF40060CW	Cream 101/ PVC	6107711	6161 30 8		105	WDK HI20050CW	Cream 45/ PVC	6507917	6153 08 9		97
WDK HF40060GR	Stone grey 101/ PVC	6019458	6021 73 5		105	WDK HI20050RW	Pure white 45/ PVC	6974542	6154 36 0		97
WDK HF40060LGR	Light grey 101/ PVC	6673698	6183 34 4		105	WDK HI25025CW	Cream 50/ PVC	6578177	6160 04 2		99
WDK HF40060RW	Pure white 101/ PVC	6796991	6192 85 8		105	WDK HI25025GR	Stone grey 50/ PVC	6578115	6158 25 0		99
WDK HF40090CW	Cream 129/ PVC	6107773	6161 31 6		106	WDK HI25025LGR	Light grey 50/ PVC	6674718	6182 06 2		99
WDK HF40090GR	Stone grey 129/ PVC	6018253	6021 33 6		106	WDK HI25025RW	Pure white 50/ PVC	6502219	6191 88 6		99
WDK HF40090LGR	Light grey 129/ PVC	6673759	6183 35 2		106	WDK HI25040CW	Cream 50/ PVC	6578351	6160 05 0		100
WDK HF40090RW	Pure white 129/ PVC	6797059	6192 86 6		106	WDK HI25040GR	Stone grey 50/ PVC	6578290	6158 26 9		100
WDK HF40110CW	Cream 110/ PVC	6107834	6161 32 4		107	WDK HI25040RW	Pure white 50/ PVC	6794775	6191 89 4		100
WDK HF40110GR	Stone grey 110/ PVC	6019519	6021 74 3		107	WDK HI30030CW	Cream 52/ PVC	6578719	6160 07 7		102
WDK HF40110LGR	Light grey 110/ PVC	6673810	6183 36 0		107	WDK HI30030GR	Stone grey 52/ PVC	6578658	6158 28 5		102
WDK HF40110RW	Pure white 110/ PVC	6496990	6192 87 4		107	WDK HI30030LGR	Light grey 52/ PVC	6674770	6182 09 7		102
WDK HF60060CW	Cream 101/ PVC	6108077	6161 50 2		108	WDK HI30030RW	Pure white 52/ PVC	6794836	6191 92 4		102
WDK HF60060GR	Stone grey 101/ PVC	6022519	6022 44 8		108	WDK HI30045CW	Cream 52/ PVC	6641413	6160 08 5		103
WDK HF60060LGR	Light grey 101/ PVC	6677719	6183 40 9		108	WDK HI30045GR	Stone grey 52/ PVC	6641352	6158 30 7		103
WDK HF60060RW	Pure white 101/ PVC	6712694	6192 91 2		108	WDK HI30045LGR	Light grey 52/ PVC	6674831	6182 10 0		103
WDK HF60090CW	Cream 129/ PVC	6108138	6161 51 0		109	WDK HI30045RW	Pure white 52/ PVC	6976829	6191 93 2		103
WDK HF60090GR	Stone grey 129/ PVC	6021796	6022 31 6		109	WDK HI40040CW	Cream 65/ PVC	6584598	6160 09 3		104
WDK HF60090LGR	Light grey 129/ PVC	6677771	6183 41 7		109	WDK HI40040GR	Stone grey 65/ PVC	6578832	6158 29 3		104
WDK HF60090RW	Pure white 129/ PVC	6492619	6192 92 0		109	WDK HI40040LGR	Light grey 65/ PVC	6674893	6182 11 9		104
WDK HF60110CW	Cream 149/ PVC	6108190	6161 52 9		111	WDK HI40040RW	Pure white 65/ PVC	6794898	6191 94 0		104
WDK HF60110GR	Stone grey 149/ PVC	6021918	6022 33 2		111	WDK HI40060CW	Cream 110/ PVC	6105915	6160 10 7		105
WDK HF60110LGR	Light grey 149/ PVC	6677832	6183 42 5		111	WDK HI40060GR	Stone grey 110/ PVC	6019335	6021 71 9		105
WDK HF60110RW	Pure white 149/ PVC	6712755	6192 93 9		111	WDK HI40060LGR	Light grey 110/ PVC	6674954	6182 12 7		105
WDK HF60130CW	Cream 170/ PVC	6108251	6161 53 7		112	WDK HI40060RW	Pure white 110/ PVC	6794959	6191 95 9		105
WDK HF60130GR	Stone grey 170/ PVC	6022038	6022 35 9		112	WDK HI40090CW	Cream 109/ PVC	6105977	6160 11 2		106
WDK HF60130LGR	Light grey 170/ PVC	6677894	6183 43 3		112	WDK HI40090GR	Stone grey 109/ PVC	6017652	6021 19 0		106
WDK HF60130RW	Pure white 170/ PVC	6712816	6192 94 7		112	WDK HI40090LGR	Light grey 109/ PVC	6675012	6182 13 5		106
WDK HF60150CW	Cream 190/ PVC	6638536	6161 56 1		113	WDK HI40090RW	Pure white 109/ PVC	6795017	6191 96 7		106
WDK HF60150GR	Stone grey 190/ PVC	6638475	6024 59 9		113	WDK HI40110CW	Cream 110,5/ PVC	6106035	6160 12 3		107
WDK HF60150LGR	Light grey 190/ PVC	6677955	6183 44 1		113	WDK HI40110GR	Stone grey 110,5/ PVC	6019397	6021 72 7		107
WDK HF60150RW	Pure white 190/ PVC	6492671	6192 95 5		113	WDK HI40110LGR	Light grey 110,5/ PVC	6675074	6182 14 3		107
WDK HF60170CW	Cream 211/ PVC	6108312	6161 54 5		114	WDK HI40110RW	Pure white 110,5/ PVC	6221110	6191 97 5		107
WDK HF60170GR	Stone grey 211/ PVC	6022151	6022 37 5		114	WDK HI60060CW	Cream 130/ PVC	6106271	6160 30 1		108
WDK HF60170LGR	Light grey 211/ PVC	6678013	6183 46 8		114	WDK HI60060GR	Stone grey 130/ PVC	6022212	6022 38 3		108
WDK HF60170RW	Pure white 211/ PVC	6712878	6192 96 3		114	WDK HI60060LGR	Light grey 130/ PVC	6675739	6182 19 4		108
WDK HF60210CW	Cream 250/ PVC	6108374	6161 55 3		115	WDK HI60060RW	Pure white 130/ PVC	6362950	6192 01 7		108
WDK HF60210GR	Stone grey 250/ PVC	6022274	6022 39 1		115	WDK HI60090CW	Cream 130/ PVC	6106332	6160 32 8		109
WDK HF60210LGR	Light grey 250/ PVC	6678075	6183 47 6		115	WDK HI60090GR	Stone grey 130/ PVC	6021253	6022 21 9		109
WDK HF60210RW	Pure white 250/ PVC	6797110	6192 97 1		110	WDK HI60090LGR	Light grey 130/ PVC	6675791	6182 20 8		109
WDK HF60230CW	Cream 270/ PVC	6639915	6161 59 6		110	WDK HI60090RW	Pure white 130/ PVC	6799879	6192 02 5		109
WDK HF60230GR	Stone grey 270/ PVC	6639854	6024 60 2		110	WDK HI60110CW	Cream 130/ PVC	6106394	6160 33 6		111
WDK HF60230LGR	Light grey 270/ PVC	6678136	6183 48 4		110	WDK HI60110GR	Stone grey 130/ PVC	6021376	6022 23 5		111
WDK HF60230RW	Pure white 270/ PVC	6492732	6192 99 8		110	WDK HI60110LGR	Light grey 130/ PVC	6675852	6182 21 6		111
WDK HF80170CW	Cream 206/ PVC	6108435	6161 70 7		119	WDK HI60110RW	Pure white 130/ PVC	6362776	6192 03 3		111
WDK HF80170GR	Stone grey 206/ PVC	6027859	6024 61 0		119	WDK HI60130CW	Cream 130/ PVC	6106455	6160 34 4		112
WDK HF80170LGR	Light grey 206/ PVC	6678198	6183 52 2		119	WDK HI60130GR	Stone grey 130/ PVC	6021499	6022 25 1		112
WDK HF80170RW	Pure white 206/ PVC	5042488	6193 02 1		117	WDK HI60130LGR	Light grey 130/ PVC	6675913	6182 22 4		112
WDK HF80210CW	Cream 247/ PVC	6108497	6161 71 5		117	WDK HI60130RW	Pure white 130/ PVC	6362479	6192 04 1		112
WDK HF80210GR	Stone grey 247/ PVC	6027910	6024 62 9		117	WDK HI60150CW	Cream 130/ PVC	6638178	6160 37 9		113
WDK HF80210LGR	Light grey 247/ PVC	6678259	6183 53 0		117	WDK HI60150GR	Stone grey 130/ PVC	6638116	6024 43 2		113
WDK HF80210RW	Pure white 247/ PVC	5042570	6193 02 5		117						

Type listing

Structure of the EAN number: Country code 40

Manufacturer code 1219 (for articles beginning with 0: 1010)

Individual EAN-C 5647589

Type	Dimensions/Colour/Div.	EAN-C.	Art. no.	Price	Page	Type	Dimensions/Colour/Div.	EAN-C.	Art. no.	Price	Page
WDK HI60150LGR	Light grey 130/ PVC	6675975	6182 23 2	/pc.	113	WDK HK80170CW	Cream 282/ PVC	6109333	6162 40 1	/pc.	119
WDK HI60150RW	Pure white 130/ PVC	6800056	6192 06 8		113	WDK HK80170GR	Stone grey 282/ PVC	6028030	6024 79 3		119
WDK HI60170CW	Cream 130/ PVC	6106516	6160 35 2		114	WDK HK80170LGR	Light grey 282/ PVC	6677535	6183 12 3		119
WDK HI60170GR	Stone grey 130/ PVC	6021611	6022 28 6		114	WDK HK80170RW	Pure white 282/ PVC	5042471	6192 71 8		119
WDK HI60170LGR	Light grey 130/ PVC	6676033	6182 24 0		114	WDK HK80210CW	Cream 282/ PVC	6109395	6162 42 8		117
WDK HI60170RW	Pure white 130/ PVC	6362233	6192 07 6		114	WDK HK80210GR	Stone grey 282/ PVC	6028092	6024 80 7		117
WDK HI60210CW	Cream 130/ PVC	6106578	6160 36 0		115	WDK HK80210LGR	Light grey 282/ PVC	6677597	6183 13 1		117
WDK HI60210GR	Stone grey 130/ PVC	6021673	6022 29 4		115	WDK HK80210RW	Pure white 282/ PVC	5042549	6192 72 2		117
WDK HI60210LGR	Light grey 130/ PVC	6676095	6182 25 9		115						
WDK HI60210RW	Pure white 130/ PVC	6795079	6192 08 4		115	WDK HS10020CW	Cream 22/ PVC	6098293	6152 00 7		86
WDK HI60230CW	Cream 130/ PVC	6639557	6160 39 5		110	WDK HS10020RW	Pure white 22/ PVC	6492138	6154 02 6		86
WDK HI60230GR	Stone grey 130/ PVC	6639496	6024 44 0		110	WDK HS10030CW	Cream 32/ PVC	6098354	6152 01 5		88
WDK HI60230LGR	Light grey 130/ PVC	6676156	6182 26 7		110	WDK HS10030RW	Pure white 32/ PVC	6491650	6154 03 4		88
WDK HI60230RW	Pure white 130/ PVC	6800896	6192 09 2		110						
						WDK HS15030CW	Cream 32/ PVC	6507610	6152 03 1		91
WDK HI80170CW	Cream 150/ PVC	6106639	6160 48 4		119	WDK HS15030GR	Stone grey 32/ PVC	6507559	6158 83 8		91
WDK HI80170GR	Stone grey 150/ PVC	6027491	6024 46 7		119	WDK HS15030RW	Pure white 32/ PVC	6223695	6193 50 1		91
WDK HI80170LGR	Light grey 150/ PVC	6676217	6182 30 5		119	WDK HS15040CW	Cream 42/ PVC	6098477	6152 05 8		93
WDK HI80170RW	Pure white 150/ PVC	5042457	6192 10 6		119	WDK HS15040GR	Stone grey 42/ PVC	6507498	6158 84 6		93
WDK HI80210CW	Cream 150/ PVC	6106691	6160 49 2		117	WDK HS15040RW	Pure white 42/ PVC	6975266	6193 52 8		93
WDK HI80210GR	Stone grey 150/ PVC	6027552	6024 47 5		117						
WDK HI80210LGR	Light grey 150/ PVC	6676279	6182 31 3		117	WDK HS20050CW	Cream 53/ PVC	6507252	6152 10 4		97
WDK HI80210RW	Pure white 150/ PVC	5042525	6192 11 0		117	WDK HS20050RW	Pure white 53/ PVC	6974481	6154 06 9		97
WDK HK100130CW	Cream 282/ PVC	6109456	6162 45 2		118	WDK HS25040CW	Cream 42/ PVC	6507375	6152 08 2		100
WDK HK100130GR	Stone grey 282/ PVC	6028153	6024 81 5		118	WDK HS25040GR	Stone grey 42/ PVC	6507436	6158 88 9		100
WDK HK100130LGR	Light grey 282/ PVC	6677658	6183 16 6		118	WDK HS25040RW	Pure white 42/ PVC	6507313	6193 56 0		100
WDK HK100130RW	Pure white 282/ PVC	5042631	6192 72 6		118						
WDK HK100230CW	Cream 282/ PVC	6501618	6162 47 9		120	WDK HT10020CW	Cream 45/ PVC	6098712	6152 30 9		86
WDK HK100230GR	Stone grey 282/ PVC	6501670	6024 71 8		120	WDK HT10020RW	Pure white 45/ PVC	6491957	6154 11 5		86
WDK HK100230LGR	Light grey 282/ PVC	6501373	6183 18 2		120	WDK HT10030CW	Cream 55/ PVC	6098774	6152 31 7		88
WDK HK100230RW	Pure white 282/ PVC	5042709	6192 73 0		120	WDK HT10030RW	Pure white 55/ PVC	6491476	6154 12 3		88
WDK HK40060CW	Cream 190/ PVC	6108619	6162 00 2		105	WDK HT15030CW	Cream 73/ PVC	6580637	6161 92 8		92
WDK HK40060GR	Stone grey 190/ PVC	6025459	6023 31 2		105	WDK HT15030GR	Stone grey 73/ PVC	6580576	6158 46 3		92
WDK HK40060LGR	Light grey 190/ PVC	6673155	6182 92 5		105	WDK HT15030RW	Pure white 73/ PVC	6796212	6192 45 9		92
WDK HK40060RW	Pure white 190/ PVC	6796519	6192 55 6		105	WDK HT15040CW	Cream 83/ PVC	6580811	6161 93 6		94
WDK HK40090CW	Cream 230/ PVC	6108671	6162 01 0		106	WDK HT15040GR	Stone grey 83/ PVC	6580750	6158 47 1		94
WDK HK40090GR	Stone grey 230/ PVC	6024551	6023 14 2		106	WDK HT15040RW	Pure white 83/ PVC	6494774	6192 46 7		94
WDK HK40090LGR	Light grey 230/ PVC	6673216	6182 93 3		106						
WDK HK40090RW	Pure white 230/ PVC	6796571	6192 56 4		106	WDK HT20020CW	Cream 57/ PVC	6580453	6161 90 1		95
WDK HK40110CW	Cream 272/ PVC	6108732	6162 02 9		107	WDK HT20020GR	Stone grey 57/ PVC	6580392	6158 45 5		95
WDK HK40110GR	Stone grey 272/ PVC	6025572	6023 33 9		107	WDK HT20020LGR	Light grey 57/ PVC	6672851	6182 80 1		95
WDK HK40110LGR	Light grey 272/ PVC	6673278	6182 94 1		107	WDK HT20020RW	Pure white 57/ PVC	6796274	6192 47 5		95
WDK HK40110RW	Pure white 272/ PVC	6500833	6192 57 2		107	WDK HT20050CW	Cream 93/ PVC	6507795	6152 38 4		97
						WDK HT20050RW	Pure white 93/ PVC	6493272	6154 16 6		97
WDK HK60060CW	Cream 190/ PVC	6108978	6162 20 7		108	WDK HT25025CW	Cream 68/ PVC	6580996	6161 94 4		99
WDK HK60060GR	Stone grey 190/ PVC	6025039	6023 22 3		108	WDK HT25025GR	Stone grey 68/ PVC	6580934	6158 49 8		99
WDK HK60060LGR	Light grey 190/ PVC	6677054	6183 01 8		108	WDK HT25025LGR	Light grey 68/ PVC	6672912	6182 85 2		99
WDK HK60060RW	Pure white 190/ PVC	6351794	6192 61 0		108	WDK HT25025RW	Pure white 68/ PVC	6504978	6192 48 3		99
WDK HK60090CW	Cream 230/ PVC	6109036	6162 21 5		109	WDK HT25040CW	Cream 83/ PVC	6581177	6161 95 2		101
WDK HK60090GR	Stone grey 230/ PVC	6023837	6023 00 2		109	WDK HT25040GR	Stone grey 83/ PVC	6581115	6158 50 1		101
WDK HK60090LGR	Light grey 230/ PVC	6677115	6183 02 6		109	WDK HT25040RW	Pure white 83/ PVC	6796335	6192 49 1		101
WDK HK60090RW	Pure white 230/ PVC	6492435	6192 62 9		109						
WDK HK60110CW	Cream 272/ PVC	6109098	6162 22 3		111						
WDK HK60110GR	Stone grey 272/ PVC	6023950	6023 02 9		111	WDK HT30030CW	Cream 50/ PVC	6581535	6161 97 9		102
WDK HK60110LGR	Light grey 272/ PVC	6677177	6183 03 4		111	WDK HT30030GR	Stone grey 50/ PVC	6581474	6158 53 6		102
WDK HK60110RW	Pure white 272/ PVC	6712519	6192 63 7		111	WDK HT30030LGR	Light grey 50/ PVC	6672974	6182 88 7		102
WDK HK60130CW	Cream 272/ PVC	6109159	6162 23 1		112	WDK HT30030RW	Pure white 50/ PVC	6796397	6192 51 3		102
WDK HK60130GR	Stone grey 272/ PVC	6024070	6023 04 5		112	WDK HT30045CW	Cream 88/ PVC	6641956	6161 98 7		103
WDK HK60130LGR	Light grey 272/ PVC	6677238	6183 04 2		112	WDK HT30045GR	Stone grey 88/ PVC	6641895	6158 55 2		103
WDK HK60130RW	Pure white 272/ PVC	6712571	6192 64 5		112	WDK HT30045LGR	Light grey 88/ PVC	6673032	6182 89 5		103
WDK HK60150CW	Cream 291/ PVC	6638710	6162 27 4		113	WDK HT30045RW	Pure white 88/ PVC	6497232	6192 52 1		103
WDK HK60150GR	Stone grey 291/ PVC	6638659	6024 76 9		113						
WDK HK60150LGR	Light grey 291/ PVC	6677290	6183 05 0		113	WDK HT40040CW	Cream 83/ PVC	6581719	6161 99 5		104
WDK HK60150RW	Pure white 291/ PVC	6492497	6192 65 3		113	WDK HT40040GR	Stone grey 83/ PVC	6581658	6158 54 4		104
WDK HK60170CW	Cream 291/ PVC	6109210	6162 25 8		114	WDK HT40040LGR	Light grey 83/ PVC	6673094	6182 91 7		104
WDK HK60170GR	Stone grey 291/ PVC	6024193	6023 06 1		114	WDK HT40040RW	Pure white 83/ PVC	6796458	6192 54 8		104
WDK HK60170LGR	Light grey 291/ PVC	6677351	6183 06 9		114						
WDK HK60170RW	Pure white 291/ PVC	6712632	6192 66 1		114						
WDK HK60210CW	Cream 291/ PVC	6109272	6162 26 6		115	WDK100130CW	Cream 2000/ PVC	6030132	6026 27 3	/m	118
WDK HK60210GR	Stone grey 291/ PVC	6024438	6023 12 6		115	WDK100130GR	Stone grey 2000/ PVC	6030194	6026 28 1		118
WDK HK60210LGR	Light grey 291/ PVC	6677412	6183 07 7		115	WDK100130LGR	Light grey 2000/ PVC	6668595	6027 24 5		118
WDK HK60210RW	Pure white 291/ PVC	6796632	6192 68 8		115	WDK100130RW	Pure white 2000/ PVC	5042297	6191 34 7		118
WDK HK60230CW	Cream 291/ PVC	6640096	6162 29 0		110						
WDK HK60230GR	Stone grey 291/ PVC	6640034	6024 77 7		110	WDK10020CW	Cream 2000/ PVC	6098170	6150 75 6		86
WDK HK60230LGR	Light grey 291/ PVC	6677474	6183 08 5		110	WDK10020RW	Pure white 2000/ PVC	6492251	6150 76 4		86
WDK HK60230RW	Pure white 291/ PVC	6492558	6192 69 6		110						
						WDK100230CW	Cream 2000/ PVC	6642137	6026 33 8		120
						WDK100230GR	Stone grey 2000/ PVC	6642076	6026 31 1		120

06 LFS_Katalog_2010_Neuer_Stand / en / 22/02/2010 (LLEXP00995)

Type	Dimensions/Colour/Div.	EAN-C.	Art. no.	Price	Page	Type	Dimensions/Colour/Div.	EAN-C.	Art. no.	Price	Page
WDK100230LGR	Light grey 2000 / PVC	6668656	6027 25 3	/m	120	WDK60110CW	Cream 2000 / PVC	6019816	6021 84 0	/m	111
WDK100230RW	Pure white 2000 / PVC	5042303	6191 35 5		120	WDK60110GR	Stone grey 2000 / PVC	6020294	6022 01 4		111
						WDK60110LGR	Light grey 2000 / PVC	6668113	6027 12 1		111
WDK10030CW	Cream 2000 / PVC	6508037	6150 77 2		88	WDK60110RW	Pure white 2000 / PVC	6363438	6191 21 5		111
WDK10030RW	Pure white 2000 / PVC	6491773	6150 78 0		88						
						WDK60130CW	Cream 2000 / PVC	6019878	6021 85 9		112
WDK15015CW	Cream 2000 / PVC	6642311	6024 96 3		90	WDK60130GR	Stone grey 2000 / PVC	6020355	6022 02 2		112
WDK15015GR	Stone grey 2000 / PVC	6642250	6024 95 5		90	WDK60130LGR	Light grey 2000 / PVC	6668175	6027 14 8		112
WDK15015LGR	Light grey 2000 / PVC	6667338	6024 94 7		90	WDK60130RW	Pure white 2000 / PVC	6363377	6191 22 3		112
WDK15015RW	Pure white 2000 / PVC	6794058	6191 00 2		90						
						WDK60150CW	Cream 2000 / PVC	6637577	6021 88 3		113
WDK15030CW	Cream 2000 / PVC	6332830	6025 01 3		91	WDK60150GR	Stone grey 2000 / PVC	6637515	6022 03 0		113
WDK15030GR	Stone grey 2000 / PVC	6332779	6025 00 5		91	WDK60150LGR	Light grey 2000 / PVC	6668236	6027 15 6		113
WDK15030RW	Pure white 2000 / PVC	6794119	6191 01 0		91	WDK60150RW	Pure white 2000 / PVC	6491230	6191 23 1		113
WDK15040CW	Cream 2000 / PVC	6028634	6025 16 1		93	WDK60170CW	Cream 2000 / PVC	6019939	6021 86 7		114
WDK15040GR	Stone grey 2000 / PVC	6028511	6025 13 7		93	WDK60170GR	Stone grey 2000 / PVC	6020416	6022 04 9		114
WDK15040RW	Pure white 2000 / PVC	6494590	6191 02 9		93	WDK60170LGR	Light grey 2000 / PVC	6668298	6027 16 4		114
						WDK60170RW	Pure white 2000 / PVC	6363193	6191 25 8		114
WDK20020CW	Cream 2000 / PVC	6028573	6025 15 3		95						
WDK20020GR	Stone grey 2000 / PVC	6028399	6025 11 0		95	WDK60210CW	Cream 2000 / PVC	6019991	6021 87 5		115
WDK20020LGR	Light grey 2000 / PVC	6667390	6025 10 2		95	WDK60210GR	Stone grey 2000 / PVC	6020478	6022 06 5		115
WDK20020RW	Pure white 2000 / PVC	6794171	6191 03 7		95	WDK60210LGR	Light grey 2000 / PVC	6668359	6027 17 2		115
						WDK60210RW	Pure white 2000 / PVC	6794478	6191 26 6		115
WDK20035CW	Cream 2000 / PVC	6642854	6026 37 0		96	WDK60230CW	Cream 2000 / PVC	6638956	6021 89 1		110
WDK20035GR	Stone grey 2000 / PVC	6642793	6026 36 2		96	WDK60230GR	Stone grey 2000 / PVC	6638895	6022 05 7		110
WDK20035LGR	Light grey 2000 / PVC	6667451	6026 35 4		96	WDK60230LGR	Light grey 2000 / PVC	6668410	6027 18 0		110
WDK20035RW	Pure white 2000 / PVC	6496938	6191 04 5		96	WDK60230RW	Pure white 2000 / PVC	6799459	6191 27 4		110
WDK20050CW	Cream 2000 / PVC	6438433	6168 70 1		97						
WDK20050RW	Pure white 2000 / PVC	6801671	6168 73 6		97	WDK80170CW	Cream 2000 / PVC	6029778	6026 17 6		119
						WDK80170GR	Stone grey 2000 / PVC	6029839	6026 18 4		119
WDK25025CW	Cream 2000 / PVC	6030316	6026 42 7		99	WDK80170LGR	Light grey 2000 / PVC	6668472	6027 22 9		119
WDK25025GR	Stone grey 2000 / PVC	6030255	6026 41 9		99	WDK80170RW	Pure white 2000 / PVC	5042273	6191 30 4		119
WDK25025LGR	Light grey 2000 / PVC	6667512	6026 40 0		99						
WDK25025RW	Pure white 2000 / PVC	6505036	6191 05 3		99	WDK80210CW	Cream 2000 / PVC	6029952	6026 20 6		117
						WDK80210GR	Stone grey 2000 / PVC	6029891	6026 19 2		117
WDK25040CW	Cream 2000 / PVC	6030491	6026 45 1		100	WDK80210LGR	Light grey 2000 / PVC	6668533	6027 23 7		117
WDK25040GR	Stone grey 2000 / PVC	6030439	6026 44 3		100	WDK80210RW	Pure white 2000 / PVC	5042280	6191 31 2		117
WDK25040RW	Pure white 2000 / PVC	6794232	6191 06 1		100						
						WDK-H20020	Pure white 2000 / PC/ABS	5237396	6175 00 2		128
WDK30030CW	Cream 2000 / PVC	6333011	6026 82 6		102	WDK-H30045	Pure white 2000 / PC/ABS	5237402	6175 00 8		129
WDK30030GR	Stone grey 2000 / PVC	6332953	6026 81 8		102						
WDK30030LGR	Light grey 2000 / PVC	6667574	6026 79 6		102	WDK-H40060	Pure white 2000 / PC/ABS	5237419	6175 01 4		130
WDK30030RW	Pure white 2000 / PVC	6794294	6191 09 6		102	WDK-H40061	Pure white 2000 / PC/ABS	5237426	6175 02 0		131
WDK30045CW	Cream 2000 / PVC	6640935	6026 86 9		103	WDK-H60090	Pure white 2000 / PC/ABS	5237457	6175 02 6		132
WDK30045GR	Stone grey 2000 / PVC	6640874	6026 85 0		103						
WDK30045LGR	Light grey 2000 / PVC	6667635	6026 84 2		103	WDK-H60110	Pure white 2000 / PC/ABS	5237464	6175 03 2		133
WDK30045RW	Pure white 2000 / PVC	6497058	6191 11 8		103	WDK-H60150	Pure white 2000 / PC/ABS	5237471	6175 03 8		134
WDK40040CW	Cream 2000 / PVC	6028870	6025 41 2		104						
WDK40040GR	Stone grey 2000 / PVC	6028993	6025 44 7		104						
WDK40040LGR	Light grey 2000 / PVC	6667697	6027 01 6		104	WDK-HA30045	Pure white 60 / PC/ABS	5237549	6175 10 3	/pc.	129
WDK40040RW	Pure white 2000 / PVC	6363490	6191 12 6		104	WDK-HA40060	Pure white 85 / PC/ABS	5237556	6175 10 9		130
						WDK-HA40061	Pure white 85 / PC/ABS	5237563	6175 11 5		131
WDK40060CW	Cream 2000 / PVC	6016273	6020 88 7		105	WDK-HA60090	Pure white 130 / PC/ABS	5237570	6175 12 1		132
WDK40060GR	Stone grey 2000 / PVC	6029112	6025 63 3		105	WDK-HA60110	Pure white 130 / PC/ABS	5237587	6175 12 7		133
WDK40060LGR	Light grey 2000 / PVC	6667758	6027 02 4		105	WDK-HA60150	Pure white 130 / PC/ABS	5237594	6175 13 3		134
WDK40060RW	Pure white 2000 / PVC	6794355	6191 13 4		105						
						WDK-HE20020	Pure white 19 / PC/ABS	5237600	6175 15 0		128
WDK40090CW	Cream 2000 / PVC	6016334	6020 89 5		106	WDK-HE30045	Pure white 45 / PC/ABS	5237631	6175 15 6		129
WDK40090GR	Stone grey 2000 / PVC	6016877	6021 01 8		106						
WDK40090LGR	Light grey 2000 / PVC	6667819	6027 03 2		106						
WDK40090RW	Pure white 2000 / PVC	6794416	6191 14 2		106						
						WDK-HE40060	Pure white 60 / PC/ABS	5237648	6175 16 2		130
WDK40110CW	Cream 2000 / PVC	6016396	6020 90 9		107	WDK-HE40061	Pure white 60 / PC/ABS	5237655	6175 16 8		131
WDK40110GR	Stone grey 2000 / PVC	6016990	6021 03 4		107						
WDK40110LGR	Light grey 2000 / PVC	6667871	6027 04 0		107	WDK-HE60090	Pure white 90 / PC/ABS	5237662	6175 17 4		132
WDK40110RW	Pure white 2000 / PVC	6501199	6191 15 0		107	WDK-HE60110	Pure white 110 / PC/ABS	5237693	6175 18 0		133
						WDK-HE60150	Pure white 150 / PC/ABS	5237709	6175 18 6		134
WDK60060CW	Cream 2000 / PVC	6020171	6021 94 8		108	WDK-HF30045	Pure white 60 / PC/ABS	5237716	6175 20 4		129
WDK60060GR	Stone grey 2000 / PVC	6029174	6025 66 8		108						
WDK60060LGR	Light grey 2000 / PVC	6667994	6027 10 5		108	WDK-HF40060	Pure white 85 / PC/ABS	5237723	6175 21 0		130
WDK60060RW	Pure white 2000 / PVC	6363018	6191 19 3		108	WDK-HF40061	Pure white 85 / PC/ABS	5237730	6175 21 6		131
WDK60090CW	Cream 2000 / PVC	6020119	6021 91 3		109	WDK-HF60090	Pure white 120 / PC/ABS	5237747	6175 22 2		132
WDK60090GR	Stone grey 2000 / PVC	6020232	6022 00 6		109	WDK-HF60110	Pure white 140 / PC/ABS	5237754	6175 22 8		133
WDK60090LGR	Light grey 2000 / PVC	6668052	6027 11 3		109						
WDK60090RW	Pure white 2000 / PVC	6491292	6191 20 7		109						

06_LFS_Katalog_2010_Neuer_Stand / en / 22/02/2010 (LLEExport_00995)

Type listing

Structure of the EAN number: Country code **40**

Manufacturer code **1219** (for articles beginning with **0: 1010**)

Individual EAN-C **5647589**

Type	Dimensions/Colour/Div.	EAN-C.	Art. no.	Price	Page	Type	Dimensions/Colour/Div.	EAN-C.	Art. no.	Price	Page
WDK-HF60150	Pure white 180/ PC/ABS	5237778	6175 23 4	/pc.	134	ZP-80 1RW	Pure white	5406006	6258 07 3	/pc.	355
WDK-HI30045	Pure white 60/ PC/ABS	5237488	6175 05 1		129						
WDK-HI40060	Pure white 85/ PC/ABS	5237495	6175 05 7		130						
WDK-HI40061	Pure white 85/ PC/ABS	5237501	6175 06 3		131						
WDK-HI60090	Pure white 130/ PC/ABS	5237518	6175 06 9		132						
WDK-HI60110	Pure white 130/ PC/ABS	5237525	6175 07 5		133						
WDK-HI60150	Pure white 130/ PC/ABS	5237532	6175 08 1		134						
WDK-HT30045	Pure white 130/ PC/ABS	5237785	6175 25 5		129						
WDK-HT40060	Pure white 170/ PC/ABS	5237815	6175 26 1		130						
WDK-HT40061	Pure white 170/ PC/ABS	5237822	6175 26 7		131						
WDK-HT60090	Pure white 170/ PC/ABS	5237839	6175 27 3		132						
WDK-HT60110	Pure white 190/ PC/ABS	5237846	6175 27 9		133						
WDK-HT60150	Pure white 250/ PC/ABS	5237877	6175 28 5		134						
WDKM11	Pure white 2000/ PVC	6798193	6150 10 1	/m	84						
WDKM7	Pure white 2000/ PVC	6798070	6150 07 1		84						
WDKM9	Pure white 2000/ PVC	6798131	6150 09 8		84						
WDKMD12CW	Cream 2000/ PVC	6097692	6150 17 9		84						
WDKMD12RW	Pure white 2000/ PVC	6493036	6150 28 4		84						
WDKMD17CW	Cream 2000/ PVC	6097753	6150 18 7		84						
WDKMD17RW	Pure white 2000/ PVC	6492978	6150 29 2		84						
WDKMD4CW	Cream 2000/ PVC	6097579	6150 15 2		84						
WDKMD4RW	Pure white 2000/ PVC	6493159	6150 26 8		84						
WDKMD7CW	Cream 2000/ PVC	6097630	6150 16 0		84						
WDKMD7RW	Pure white 2000/ PVC	6493098	6150 27 6		84						
WDK-N10020CW	Cream 2000/ PVC	6097814	6150 40 3		86						
WDK-N10020RW	Pure white 2000/ PVC	6492190	6150 41 1		86						
WDK-N10030CW	Cream 2000/ PVC	6097876	6150 44 6		88						
WDK-N10030RW	Pure white 2000/ PVC	6491711	6150 45 4		88						
WDK-N15030CW	Cream 2000/ PVC	6507979	6150 51 9		91						
WDK-N15030RW	Pure white 2000/ PVC	6493456	6150 52 7		91						
WDK-N15040CW	Cream 2000/ PVC	6097999	6150 53 5		93						
WDK-N15040RW	Pure white 2000/ PVC	6494477	6150 54 3		93						
WDK-N20050CW	Cream 2000/ PVC	6438495	6168 72 8		97						
WDK-N20050RW	Pure white 2000/ PVC	6802159	6168 74 4		97						
WDK-N25040CW	Cream 2000/ PVC	6507191	6150 63 2		100						
WDK-N25040RW	Pure white 2000/ PVC	6975686	6150 64 0		100						
WS-B AL0.5	Aluminium paint	5275756	6117 62 8	/pc.	345						
WS-B AL1	Aluminium paint	5275862	6117 64 1		345						
WS-B RW0.5	Pure white	5275749	6117 62 7		345						
WS-B RW1	Pure white	5275824	6117 64 0		345						
WS-B SWGR0.5	Black-grey	5701033	6117 62 6		345						
WS-B SWGR1	Black-grey	5701071	6117 64 2		345						
ZL-SKS	Cream	6180196	6117 20 5		342						
ZL-SKS	Cream	6180196	6117 20 5		344						
ZP-80 1AL	Aluminium paint	5406013	6258 07 4		355						

06 LFS_Katalog_2010_Neuer_Stand / en / 22/02/2010 (LLEXP00995)

Terms and conditions of sale and delivery
of OBO BETTERMANN GmbH & Co. KG, OBO BETTERMANN Projekt und Systemtechnik GmbH
and OBO Befestigungselemente GmbH, Menden.

1. All our supplies and services shall be governed exclusively by the following terms and conditions, including our additional terms and conditions for cable tray business transactions. Any terms and conditions of business and purchasing of the customer shall be valid only if we have acknowledged them in writing. Our quotations are without engagement; they are mere invitations to submit contract offers. Any and all transactions and agreements, including those entered into by our employees and agents shall only be binding upon our written confirmation or invoicing. The foregoing provision shall also apply to any modifications of the agreed formal requirements.

2. The documents and data pertaining to the quotation, such as illustrations, brochures, drawings, dimensions, loading capacity values and weight details are approximate only, unless they are expressly stipulated to be binding.

Samples are non-binding samples for inspection. Any purchase according to sample will be subject to customary deviations and deviations resulting from normal production processes. The properties of the sample shall be no guaranteed quality of the purchase object unless expressly stated otherwise in the confirmation of order. Samples must be returned to us at the latest within four weeks in perfect condition. If they are not returned within this period in proper condition, we shall be entitled to charge the purchase price for the sample in accordance with our current price list. All information on our products, in particular the illustrations, drawings, weight, dimension and performance data included in our quotations and printed matter shall be regarded as approximate average values and shall not represent any quality guarantee.

With regard to products made according to customer drawings, samples and other instructions of the customer, we will not provide any warranty nor assume any liability for the due and proper functioning of the product or for any other defects if and to the extent they are based upon the customer's specifications. The customer shall indemnify us from any third party claims, including claims for product liability as may be asserted against us for damages resulting from the products unless we have caused such damages by intent or gross negligence. The customer shall warrant that the manufacture and supply of products made in accordance with his instructions will not infringe any proprietary rights of third parties. Should any proprietary rights be asserted against us, we shall be entitled, without any legal review of the third party claims, to withdraw from the contract after hearing the customer, unless the third party withdraws the claims asserted against us under its proprietary rights within eight days by written declaration. The customer shall compensate us for any damage sustained as a result of the assertion of proprietary rights. In case of withdrawal, the work we have carried out so far shall be remunerated. Further rights under the statutory provisions shall not be affected thereby.

Any moulds, tools and design data produced by us for the execution of the order shall be our exclusive property. Unless expressly agreed otherwise, the customer shall not have any claims thereto, even if he has contributed to the costs of producing any such moulds, tools and design data.

3. The packing, shipping route and means of transportation shall be left to our discretion in the absence of any other agreements. They shall be charged at their cost price. We will take back undamaged cases, when being returned carriage paid, at 2/3 of the amount invoiced. The one-way or pool pallets used for transport shall be either exchanged upon taking delivery or returned. The smallest packing units stocked and listed may not be broken up for rationalisation reasons. In case of orders for different quantities, the nearest packing unit will be supplied.

We reserve the right to deviate from the agreed delivery quantity, in particular in the case of custom-made products, to a customary extent or in conformity with national or international standards. In case of a demand for adhering to a precise quantity, an express reference is necessary and subject to confirmation.

Master and call orders shall oblige the customer to accept the total quantity on which the master/call order is based. Where no particular call orders are specified in the contract, the total quantity of the master call order must be called within twelve months. If the customer fails to adhere to call deadlines, we shall be entitled to deliver and charge the total quantity in full after four weeks from written notice with reference to the consequences of any failure to call. Our rights arising from any default of the customer shall not be affected thereby.

4. Unless otherwise agreed, our prices are quoted ex works and do not include packing and insurance. The value added tax at the rate applicable on the date of dispatch will be added to our prices. The purchaser shall ensure the correctness of his VAT identification number, which he must notify to us immediately without being asked. He shall undertake to inform both us and the competent domestic tax authority without delay of any change in his name, address and VAT identification number.

Delivery shall be franco domicile within Germany, i.e. carriage and packing prepaid, if the net order value is in excess of € 1,200. For small orders below € 100 (net excluding value added tax), we shall invoice a lower quantity surcharge of € 10 (net) per order. Upon transfer of our supplies and services to a carrier or forwarding agent, at the latest upon their leaving our warehouse or supply plant, the risk shall pass to the recipient, even in case of deliveries free place of destination.

5. Delivery periods and delivery deadlines shall be approximate only unless we have expressly stated in writing that they are binding. Delivery periods shall commence upon receipt of our confirmation of order, but not before clarification of all execution details, ex place of delivery. The customer shall only be entitled to withdraw from the contract after having granted a reasonable extension of time. We reserve the right to make partial deliveries. Claims for damages and reimbursement of expenses - for any reason whatsoever - shall be subject to the provisions set out in article 10.

In the event of any circumstances that are beyond our control within the scope of normal operating risks and obstruct or make impracticable any delivery, we shall be entitled to suspend delivery by the duration of such obstruction plus a reasonable start-up period or to withdraw from the contract for the part not yet fulfilled. The purchaser can demand a statement from us as to whether we wish to deliver within a reasonable period or withdraw. If we fail to make such a statement, the purchaser may withdraw. Our notice to the purchaser shall be deemed to be sufficient evidence that we have been prevented from delivering.

Delivery time is extended in case of such events as labour disputes, strikes and lockouts, orders from the authorities, difficulties with the procurement of materials, spoiled work or post-processing, shutdowns and staff shortage as well as shortage of means of transport, and general occurrence of unforeseen events beyond our scope of influence, by the length of duration of these events.

6. Payments shall be made upon receipt of invoice less a 3% cash discount for payment within 10 days or net after 30 days from date of invoice. Erection work and all paid labour work must be paid within 10 days without deduction of any cash discount. In case of non-cash payments, the date of the credit note will be deemed to be the date of receipt of payment. Payments received shall always be credited first against costs, then against interest and then against the earliest liability. Cheques and bills of exchange shall only be accepted as means of payment. Any payment by bill of exchange shall be subject to a prior separate and written agreement, whereby all bill costs shall be borne by the customer and no discount can be granted. The customer shall have no right to refuse performance and no right of retention - for any legal reason whatsoever - unless we have acknowledged his claim beforehand in writing or his claim has the force of law.

The customer shall only be entitled to set off claims which have the force of law, are undisputed or acknowledged by us in writing.

7. We shall retain title to the goods supplied by us until all our claims arising from our business transactions with the customer have been satisfied - current account clause - and all bills of exchange or cheques submitted for payment by the customer have been honoured.

Any treatment or processing of goods subject to our retention of title (reserved goods) shall be carried out by us as the manufacturer in accordance with § 950 BGB (German Civil Code) without any obligation on our part. If our reserved goods are to be regarded as the main item or the main item is owned by the customer, full title to the new item shall pass to us when it is created. In other cases, we shall acquire a co-ownership interest in the new item in the proportion of the sales value of our reserved goods to the other goods used for the new item at the time of processing, intermingling, joining or mixing. The customer shall take custody of our ownership or co-ownership interest free of charge; it shall be treated as reserved goods.

Before transfer of title, our goods shall be neither pledged nor assigned as collateral without our prior consent. In addition, any third party rights or pledges shall be notified to us immediately and we shall be given all details and provided all documents necessary for intervention; otherwise the customer must bear our loss. In the latter case, our total claims against the customer shall also be immediately payable.

The customer shall be entitled to sell or to use our reserved goods in the ordinary course of business subject to the condition that the relevant claims are transferred in accordance with article 8 below. This right shall lapse upon the customer's failure to promptly meet his payment obligations towards us or in the event of any cheque or bill protests or his suspension of payments. In such cases, we shall be entitled to take back the goods provisionally at the

customer's expense and to sell them to our duly exercised discretion after a corresponding reminder has been sent to the customer. We will then pass the due amount to the customer's credit.

8. If our goods are sold before payment of our claim, the customer shall be obliged to retain our title against his purchaser until the goods have been paid for in full by the purchaser. The claim arising against the purchaser from such resale as well as any other ancillary rights or security interests of the customer resulting from the sale and any claims for compensation in case of damage to or destruction of our reserved property, including the relevant insurance sum shall hereby be assigned to us. We hereby accept this assignment. Where our co-ownership interest is sold, the relevant claims shall be assigned in the amount corresponding to the value of our interest.

The customer shall, at our request, inform us of his purchasers, notify them of the assignment made and provide us with any and all documents required to assert our rights.

As long as the customer meets his contractual obligations without delay, he shall be authorised to collect the claims assigned. He shall keep the amounts collected on our behalf separately and remit them to us immediately as soon and as far as our claims become due. The authorisation shall lapse in case of any cheque or bill protest of the customer or his definite suspension of payments. The customer shall bear the costs incurred for any action taken against third parties and shall advance them upon request.

If the security provided to us by the retention of title and the anticipatory assignment should exceed the claims to be secured by more than 20%, we shall, at the customer's request, release paid supplies of our choice. Upon payment of all our claims by the customer, assigned claims shall pass to the customer.

9. Any complaints for obvious defects regarding the quantity or quality of our supplies and services that are identifiable upon careful inspection shall without delay, but at the latest within the period of limitation of eight days from arrival of the goods at the address of the customer or the person appointed by him, be notified in writing to us, not to our representatives. Slight deviations in dimensions and designs within the scope of defined technical tolerances shall not give rise to any right of complaint. Any rejected goods may only be returned to us with our prior written authorisation.

In case of justified complaints within the prescribed period, we shall, at our option, take remedial action by way of subsequent performance, by rectifying the defect, supplying non-defective goods or providing a credit note for the lower value calculated.

We shall be entitled to refuse subsequent performance in accordance with the statutory provisions. If we refuse subsequent performance, if any subsequent performance remains unsuccessful or if the customer cannot be reasonably expected to accept any subsequent performance, the latter shall be entitled to withdraw from the contract in compliance with the provisions of the following sentences. The customer shall only be entitled to withdraw from the contract - where a withdrawal is not excluded by law - upon the unsuccessful expiry of a reasonable period for subsequent performance set by him, unless this period was not required under the statutory provisions (§§ 281 para. 2, 323 para. 2, 440, 441 para. 1 BGB (German Civil Code)).

In case of his withdrawal, the customer shall be liable for any deterioration, destruction or loss of use resulting from any negligence or intent on his part. Any claims for damages or reimbursement of expenses of the customer shall be subject to the provisions set out in article 10.

In the case of any fraudulent concealment of a defect or in the case of any provision of a quality guarantee for the goods sold at the time of the passing of risk within the meaning of § 444 BGB (German Civil Code) (seller's declaration that the object sold has a specific property at the time of the passing of risk and that the seller, regardless of any fault on his part, intends to be answerable for any and all consequences resulting from its absence), the customer's rights shall be exclusively governed by the statutory provisions.

We shall - in addition to the statutory grounds for refusal - also be entitled to refuse subsequent performance if and as long as the customer fails to send us, at our request, the rejected goods or a sample thereof; the customer shall have no right of withdrawal for any such refusal. We may further refuse any subsequent performance if the goods concerned have been altered or modified without our consent unless the customer can prove that the defect was not caused by such alteration or modification.

The limitation period for any claims arising from defects shall be one year; in the case of goods which have been used in accordance with their intended purpose for a building and have caused its defectiveness, the limitation period shall be two years. The provisions of §§ 478, 479 BGB (German Civil Code) on recourse in the chain of suppliers shall not be affected thereby.

10. In the case of a pre-contractual, contractual or non-contractual breach of duty, including unsatisfactory delivery, tortious conduct and producer's liability, we shall only be liable for compensatory damages and reimbursement of expenses - subject to further contractual or statutory liability requirements - in the case of intent, gross negligence or slightly negligent breach of a material contractual duty (contractual duty the infringement of which jeopardises the fulfilment of the object of the contract). However - except in the case of intent - our liability shall be limited to the typical contractual damage that was foreseeable at the time the contract was entered into. The purchaser shall not be permitted to make a claim for expenses incurred in vain.

Except for any breach of material duties, our liability for slight negligence shall be excluded, but in any case be limited to the amount of the purchase price.

Any claim asserted by the customer or a third party for payment of a contractual penalty shall be excluded.

With regard to damages caused by delay, we shall only be liable for slight negligence up to the amount of 5% of the purchase price agreed with us.

The exclusions and limitations of liability set forth above shall not apply in the event that a guarantee is given with respect to the quality of the object sold within the meaning of § 444 BGB (German Civil Code) if a defect is fraudulently concealed or in the event of injury to life, physical injury or injury to health, or strict liability under the German Product Liability Act.

Any and all claims for damages against us, for any legal reason whatsoever, shall become statute-barred at the latest after one year from delivery of the goods to the customer, in the case of tortious liability from the time of knowledge, or grossly negligent ignorance, of the circumstances giving rise to the claim and the person liable to pay damages. This provision shall not apply in the case of liability for intent and in the event that a guarantee is given for the quality of the object sold, in the case of fraudulent concealment of a defect or in the event of injury to life, physical injury or injury to health, or strict liability under the German Product Liability Act. Any shorter limitation periods shall take precedence.

11. We shall be entitled to process and store any customer data obtained with regard to or in connection with the business relationship in accordance with the German Federal Data Protection Act, irrespective of whether such data is provided by the purchaser himself or by any third parties.

12. Place of performance for delivery and payment is Menden/Sauerland. The court of competent jurisdiction for any and all disputes, including disputes with regard to bills of exchange and cheques, is the Local Court (Amtsgericht) of Menden or, at our option, the District Court (Landgericht) of Arnsberg, irrespective of the value of the object in dispute. We shall, however, also be entitled to take legal proceedings against the customer at the place of his registered office.

German law shall be exclusively applicable. The application of international purchase laws is hereby excluded. Should, for any reason whatsoever, individual provisions of our terms and conditions of sale and delivery be invalid, the validity and binding nature of the other provisions shall not be affected thereby. The customer agrees, that the invalid provision shall be replaced by a valid provision that comes as close as possible to the economic meaning of the invalid provision.

13. The prices of products made of brass and copper are subject to certain fluctuations that are based on the relevant DEL listings. The prices of our brass articles are based on a DEL listing of € 150 for Ms 58, those of our copper products on a DEL value for electrolyte copper of € 200.

In case of any increase or reduction in these prices by more than € 15, a five per cent surcharge or deduction shall be made for each 15 points. The calculation of any such surcharges or deductions shall be based on the DEL listing of the date of our receipt of the order.

Valid from August 2004



QR-Code

With the QR Code you have direct access to our products on the Internet.

You can find further information on the QR Code at www.obo-bettermann.com.

OBO Bettermann GmbH & Co. KG

P.O. Box 1120
58694 Menden, Germany

Customer Service Germany

Tel. +49 (0)2373 891 500
Fax +49 (0)2373 897 777
E-mail: info@obo.de

www.obo-bettermann.com